

# StampS3 GroveBreakOut

SKU:A144

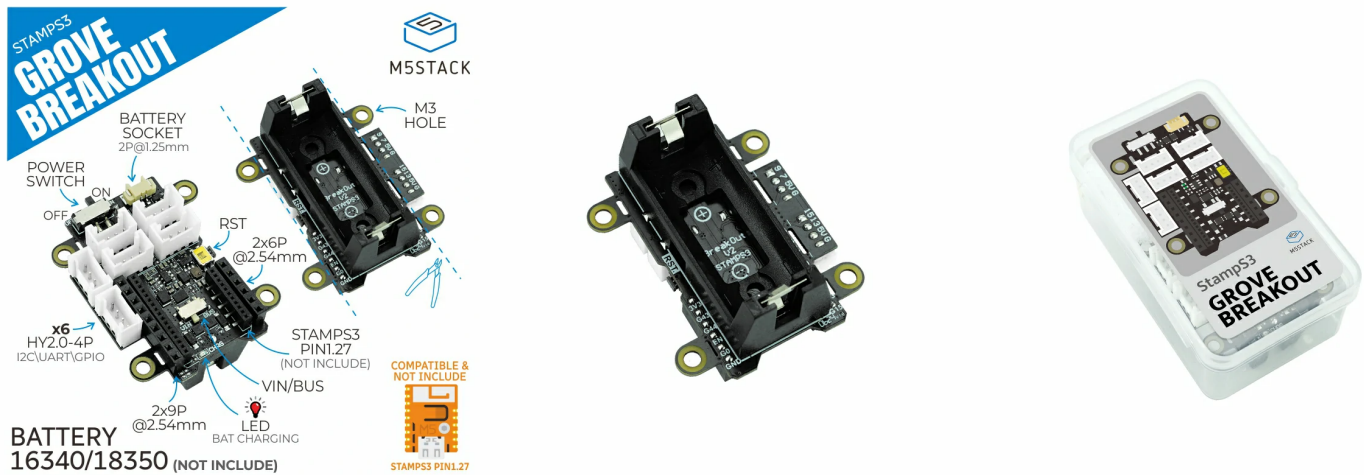

## Description

**StampS3 GroveBreakOut** is a specialized expansion board designed for the M5StampS3, equipped with six Grove interfaces and compatible with M5's portA/B/C standards, including I2C, IO (input/output), and UART interfaces. This board features an integrated holder for 16340/18350 lithium batteries, along with a 1.25mm@2P lithium battery connector, enabling it to independently power the entire system. It also includes switches for battery power supply and for switching between USB and battery power. Onboard touch switches are connected to the EN pin for reset control. Additionally, the board is equipped with a lithium battery charging chip and a 5V boost system, as well as a circuit for monitoring battery levels, providing a stable and reliable energy solution. Pre-arranged mounting holes make installation straightforward. This product is suitable for educational and prototype development, Internet of Things (IoT) projects, wearable devices, automation, and robotics among other fields.

StampS3 GroveBreakOut supports only StampS3 PIN1.27!

## Features

---

- Multi-Grove interface compatibility
- Independent power system
- Charging and power detection
- Power supply switching and reset control

## Includes

---

- 1x StampS3 GroveBreakOut

## Applications

---

- Internet of Things (IoT) projects
- Wearables and mobile devices
- Education and prototyping
- Automatic system
- Robot technology

## Specification

---

Resources	Parameters
Grove interface	6xGrove(I2C/GPIO/UART)
Battery	16340/18350 Lithium battery specifications
Bar specification	1.25mm&2.54mm
Lithium battery interface	1.25mm@2P
Grove interface Specifications	HY2.0-4P
Fixed hole size	Diameter 3mm
Operating Temperature	0- 40°C
Product Size	47.5*38*23.2mm
Package Size	75*45*29mm
Product Weight	10g
Package Weight	22.1g

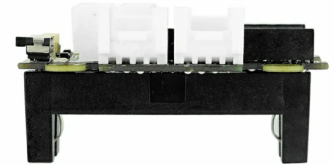
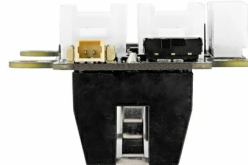
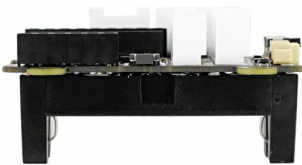
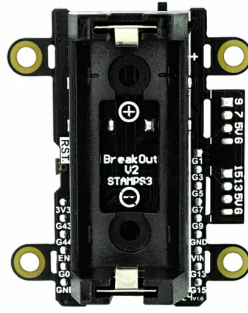
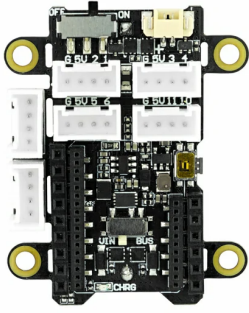

## Related Link

- [TP4057](#)

## Schematic

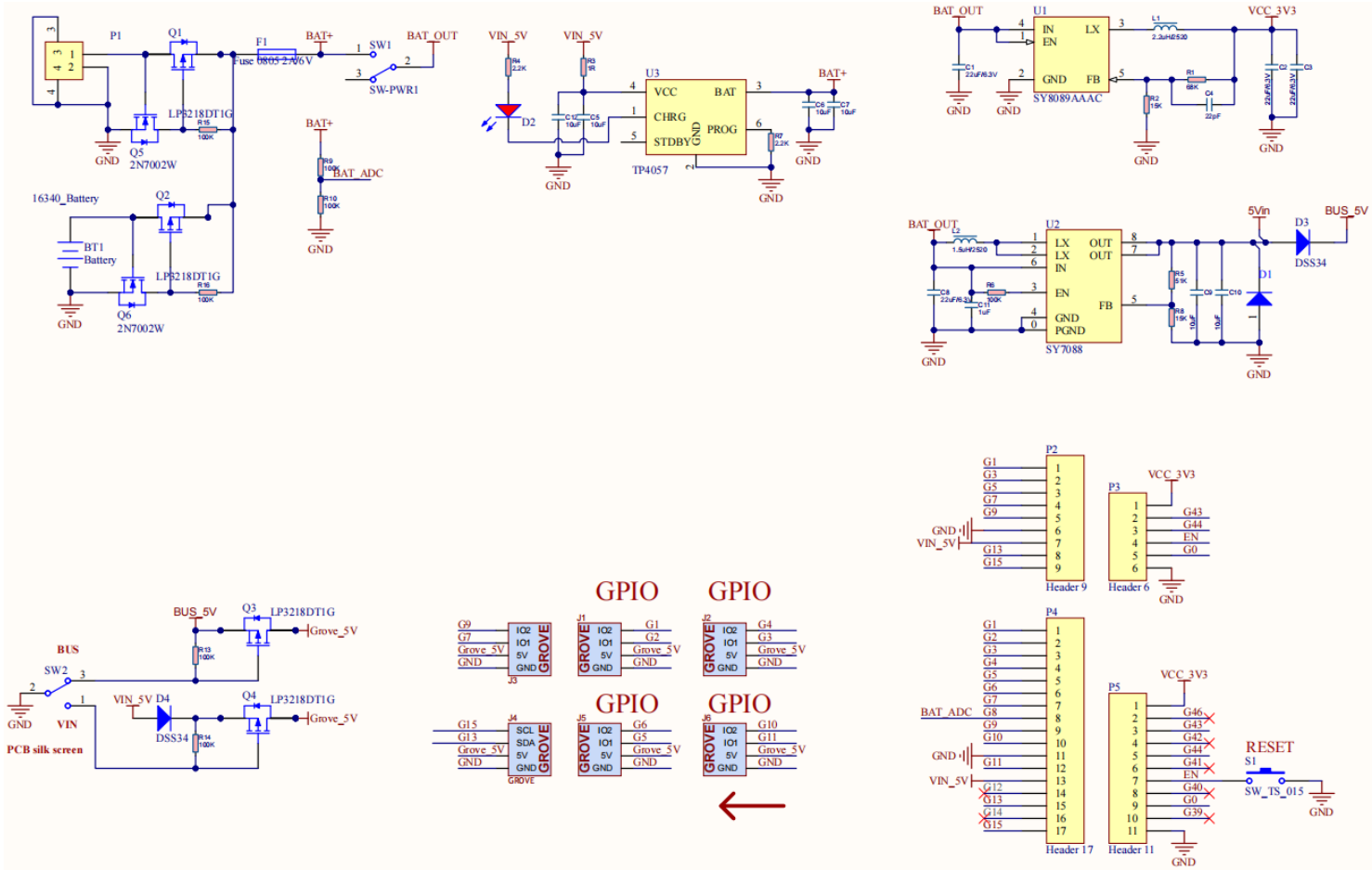

# PinMap

Grove Pin

M5StampS3	IO2	IO1	5V	GND
Grove1	G1	G2	Grove_5V	GND
Grove2	G4	G3	Grove_5V	GND
Grove3	G6	G5	Grove_5V	GND
Grove4	G10	G11	Grove_5V	GND
Grove5	G9	G7	Grove_5V	GND
Grove6	G15	G13	Grove_5V	GND

#### Battery Detect

M5StampS3	G8
Battery(ADC)	BAT_ADC

## Module Size

---

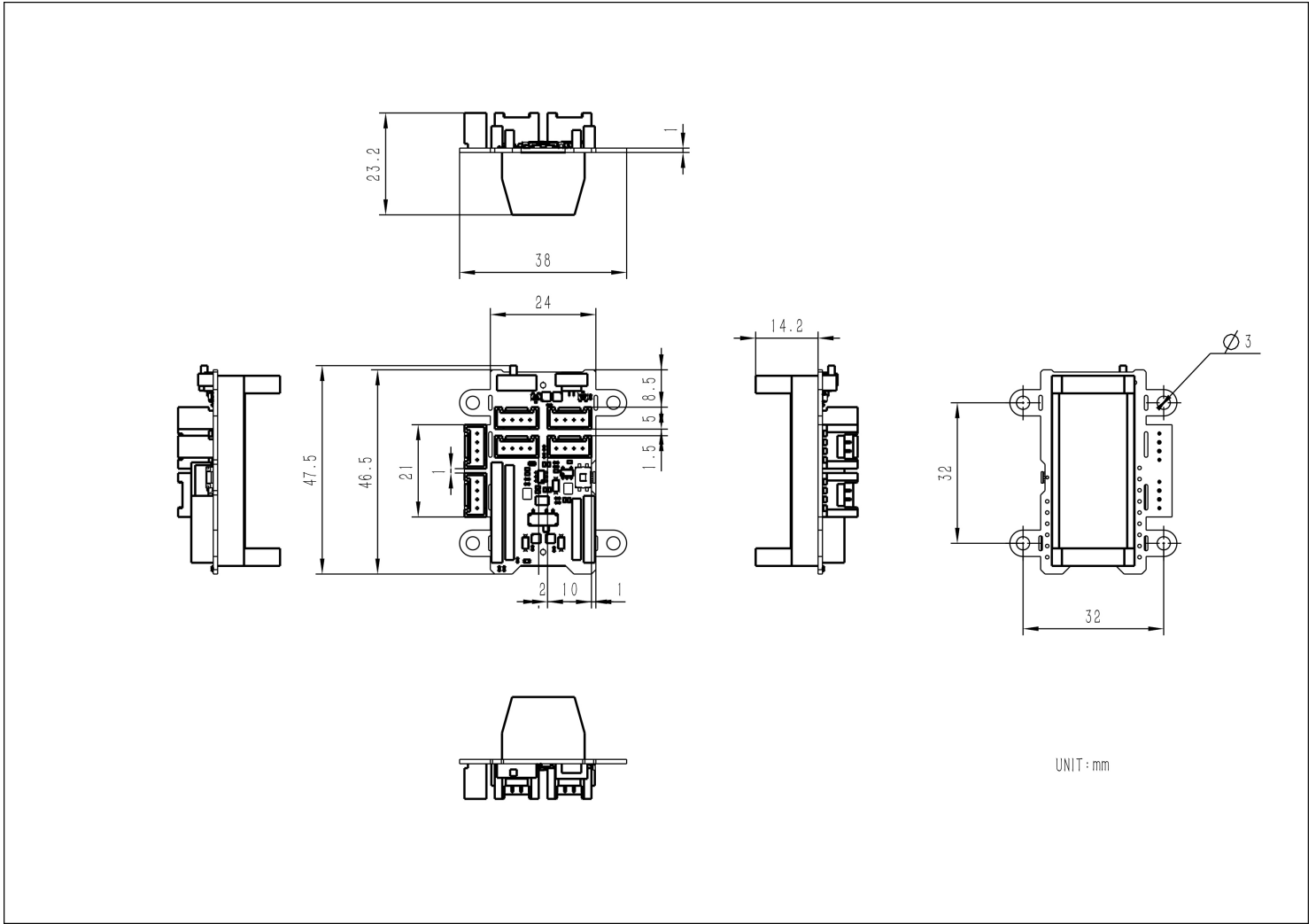

## Video

- StampS3GroveBreakOut product introduction and sample

[A144 StampS3GroveBreakOut 视频.mp4](#)