

# ESD Protection Diode Array, 5-Line

## SMS05C, SMS12C, SMS15C, SMS24C

This 5-line surge protection array is designed for application requiring transient voltage protection capability. It is intended for use in over-transient voltage and ESD sensitive equipment such as computers, printers, automotive electronics, networking communication and other applications. This device features a monolithic common anode design which protects five independent lines in a single TSOP-6 package.

### Features

- Protects up to 5 Lines in a Single TSOP-6 Package
- Peak Power Dissipation – 350 W (8 × 20 μs Waveform)
- ESD Rating of Class 3B (Exceeding 8.0 kV) per Human Body Model and Class C (Exceeding 400 V) per Machine Model
- Compliance with IEC 61000-4-2 (ESD) 15 kV (Air), 8.0 kV (Contact)
- Flammability Rating of UL 94 V-0
- SZ Prefix for Automotive and Other Applications Requiring Unique Site and Control Change Requirements; AEC-Q101 Qualified and PPAP Capable
- These are Pb-Free Devices

### Applications

- Hand-Held Portable Applications
- Networking and Telecom
- Automotive Electronics
- Serial and Parallel Ports
- Notebooks, Desktops, Servers

### MAXIMUM RATINGS (T<sub>J</sub> = 25°C unless otherwise specified)

Symbol	Rating	Value	Unit
P <sub>PK</sub> 1	Peak Power Dissipation 8 × 20 μs Double Exponential Waveform (Note 2)	350	W
T <sub>J</sub>	Operating Junction Temperature Range	-40 to 150	°C
T <sub>STG</sub>	Storage Temperature Range	-55 to 150	°C
T <sub>L</sub>	Lead Solder Temperature (10 s)	260	°C
ESD	Human Body Model (HBM) Machine Model (MM) IEC 61000-4-2 Air (ESD) IEC 61000-4-2 Contact (ESD)	>8000 >400 >15000 >8000	V

Stresses exceeding those listed in the Maximum Ratings table may damage the device. If any of these limits are exceeded, device functionality should not be assumed, damage may occur and reliability may be affected.

2. Non-repetitive current pulse per Figure 3.

## TSOP-6 FIVE SURGE PROTECTION 350 W PEAK POWER

### PIN ASSIGNMENT



TSOP-6  
CASE 318G  
SCALE 2:1

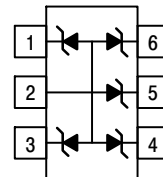

PIN 1. CATHODE  
2. ANODE  
3. CATHODE  
4. CATHODE  
5. CATHODE  
6. CATHODE

### MARKING DIAGRAM

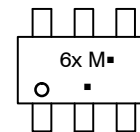

- x = SMS05C:J  
= SMS12C:K  
= SMS15C:L  
= SMS24C:M
- M = Date Code
- = Pb-Free Package

(Note: Microdot may be in either location)

### ORDERING INFORMATION

Device	Package	Shipping <sup>†</sup>
SMS05CT1G	TSOP-6 (Pb-Free)	3000 / Tape & Reel
SMS15CT1G		
SMS24CT1G		
SZSMS24CT1G		

### DISCONTINUED (Note 1)

SMS12CT1G	TSOP-6 (Pb-Free)	3000 / Tape & Reel
-----------	---------------------	--------------------

<sup>†</sup>For information on tape and reel specifications, including part orientation and tape sizes, please refer to our Tape and Reel Packaging Specification Brochure, [BRD8011/D](#).

1. **DISCONTINUED:** This device is not recommended for new design. Please contact your onsemi representative for information. The most current information on this device may be available on [www.onsemi.com](#).

## SMS05C, SMS12C, SMS15C, SMS24C

### SMS05C ELECTRICAL CHARACTERISTICS ( $T_J = 25^\circ\text{C}$ unless otherwise specified)

Symbol	Parameter	Conditions	Min	Typ	Max	Unit
$V_{RWM}$	Reverse Working Voltage	(Note 2)			5.0	V
$V_{BR}$	Breakdown Voltage	$I_T = 1.0\text{ mA}$ (Note 3)	6.2		7.2	V
$I_R$	Reverse Leakage Current	$V_{RWM} = 5.0\text{ V}$			5.0	$\mu\text{A}$
$V_C$	Clamping Voltage	$I_{PP} = 5.0\text{ A}$ ( $8 \times 20\ \mu\text{s}$ Waveform)			9.8	V
$V_C$	Clamping Voltage	$I_{PP} = 24\text{ A}$ ( $8 \times 20\ \mu\text{s}$ Waveform)			14.5	V
$I_{PP}$	Maximum Peak Pulse Current	$8 \times 20\ \mu\text{s}$ Waveform			24	A
$C_J$	Capacitance	$V_R = 0\text{ V}$ , $f = 1.0\text{ MHz}$ (Line to GND)		260	400	pF

### SMS12C ELECTRICAL CHARACTERISTICS ( $T_J = 25^\circ\text{C}$ unless otherwise specified)

Symbol	Parameter	Conditions	Min	Typ	Max	Unit
$V_{RWM}$	Reverse Working Voltage	(Note 2)			12	V
$V_{BR}$	Breakdown Voltage	$I_T = 1.0\text{ mA}$ (Note 3)	13.3		15	V
$I_R$	Reverse Leakage Current	$V_{RWM} = 12\text{ V}$		0.001	1.0	$\mu\text{A}$
$V_C$	Clamping Voltage	$I_{PP} = 5.0\text{ A}$ ( $8 \times 20\ \mu\text{s}$ Waveform)			19	V
$V_C$	Clamping Voltage	$I_{PP} = 15\text{ A}$ ( $8 \times 20\ \mu\text{s}$ Waveform)			23	V
$I_{PP}$	Maximum Peak Pulse Current	$8 \times 20\ \mu\text{s}$ Waveform			15	A
$C_J$	Capacitance	$V_R = 0\text{ V}$ , $f = 1.0\text{ MHz}$ (Line to GND)		120	150	pF

### SMS15C ELECTRICAL CHARACTERISTICS ( $T_J = 25^\circ\text{C}$ , unless otherwise specified) (See Note 5)

Symbol	Parameter	Conditions	Min	Typ	Max	Unit
$V_{RWM}$	Reverse Working Voltage	(Note 2)			15	V
$V_{BR}$	Breakdown Voltage	$I_T = 1.0\text{ mA}$ (Note 3)	17		19	V
$I_R$	Reverse Leakage Current	$V_{RWM} = 15\text{ V}$		0.05	1.0	$\mu\text{A}$
$V_C$	Clamping Voltage	$I_{PP} = 5.0\text{ A}$ ( $8 \times 20\ \mu\text{s}$ Waveform)			24	V
$V_C$	Clamping Voltage	$I_{PP} = 12\text{ A}$ ( $8 \times 20\ \mu\text{s}$ Waveform)			29	V
$I_{PP}$	Maximum Peak Pulse Current	$8 \times 20\ \mu\text{s}$ Waveform			12	A
$C_J$	Capacitance	$V_R = 0\text{ V}$ , $f = 1.0\text{ MHz}$ (Line to GND)		95	125	pF

### SZ/SMS24C ELECTRICAL CHARACTERISTICS ( $T_J = 25^\circ\text{C}$ , unless otherwise specified)

Symbol	Parameter	Conditions	Min	Typ	Max	Unit
$V_{RWM}$	Reverse Working Voltage	(Note 2)			24	V
$V_{BR}$	Breakdown Voltage	$I_T = 1.0\text{ mA}$ (Note 3)	26.7		32	V
$I_R$	Reverse Leakage Current	$V_{RWM} = 24\text{ V}$		0.001	1.0	$\mu\text{A}$
$V_C$	Clamping Voltage	$I_{PP} = 5.0\text{ A}$ ( $8 \times 20\ \mu\text{s}$ Waveform)			40	V
$V_C$	Clamping Voltage	$I_{PP} = 8\text{ A}$ ( $8 \times 20\ \mu\text{s}$ Waveform)			44	V
$I_{PP}$	Maximum Peak Pulse Current	$8 \times 20\ \mu\text{s}$ Waveform			8.0	A
$C_J$	Capacitance	$V_R = 0\text{ V}$ , $f = 1.0\text{ MHz}$ (Line to GND)		60	75	pF

3. Surge protection devices are normally selected according to the working peak reverse voltage ( $V_{RWM}$ ), which should be equal or greater than the DC or continuous peak operating voltage level.

4.  $V_{BR}$  is measured at pulse test current  $I_T$ .

5. Parametrics are the same for the Pb-Free packages, which are suffixed with a "G".

# SMS05C, SMS12C, SMS15C, SMS24C

## TYPICAL PERFORMANCE CURVES ( $T_J = 25^\circ\text{C}$ UNLESS OTHERWISE SPECIFIED)

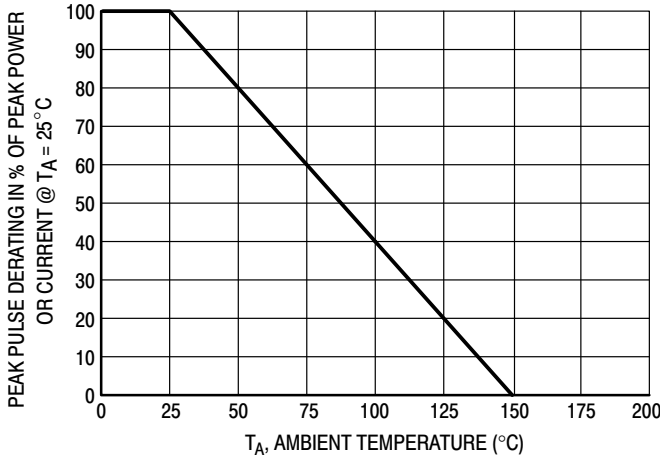

Figure 1. Pulse Derating Curve

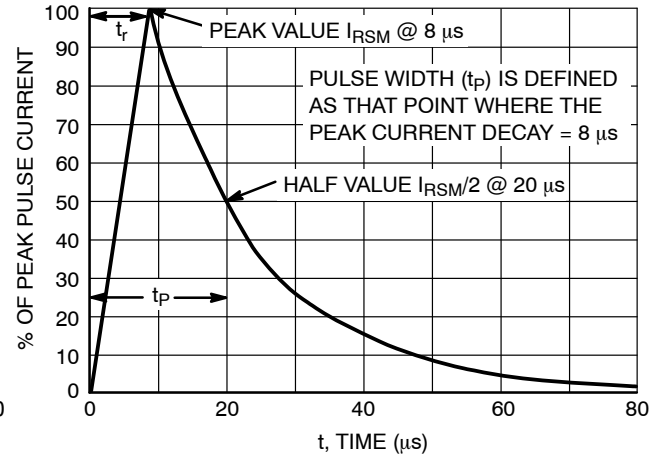

Figure 2.  $8 \times 20 \mu\text{s}$  Pulse Waveform

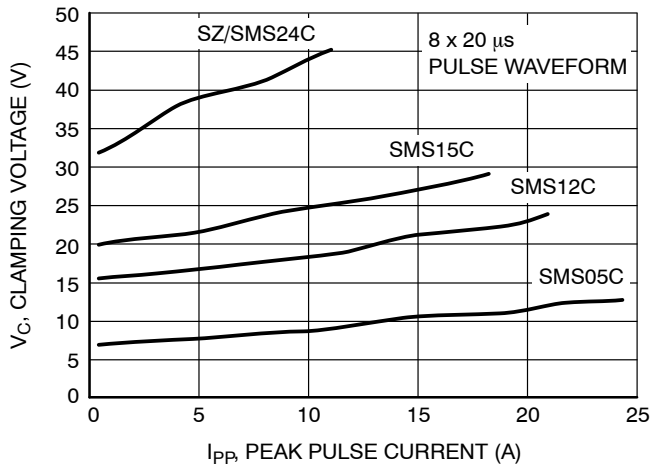

Figure 3. Clamping Voltage vs. Peak Pulse Current

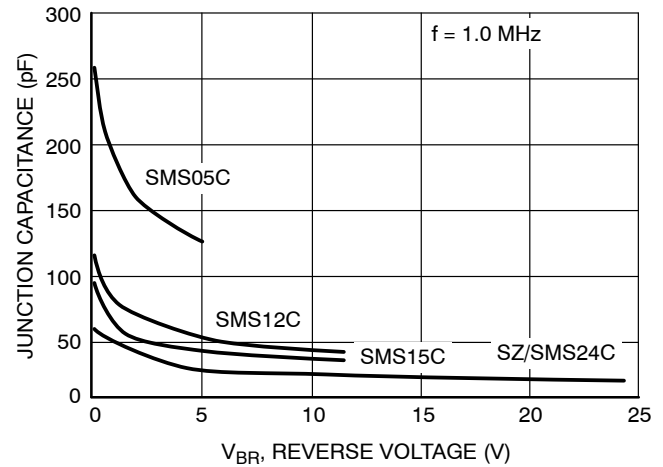

Figure 4. Junction Capacitance vs. Reverse Voltage

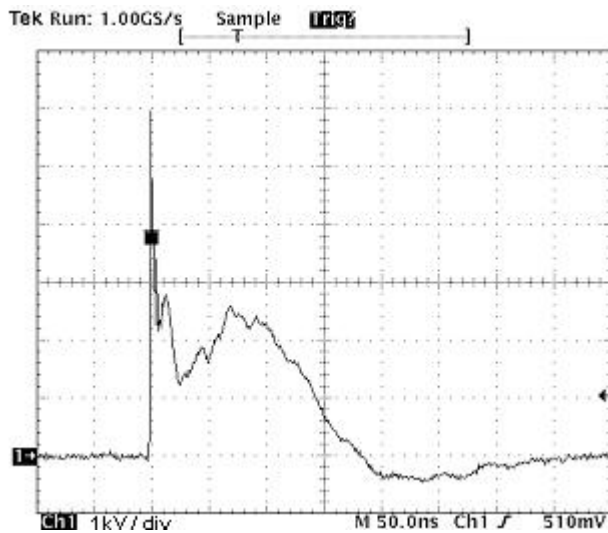

Figure 5. ESD Pulse IEC 61000-4-2 (8.0 kV Contact)

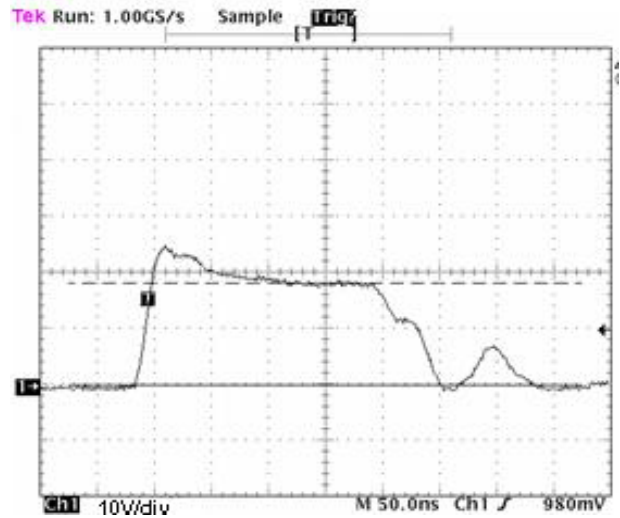

Figure 6. SMS15CT1 ESD Response for IEC 61000-4-2 (+8.0 kV Contact)

# SMS05C, SMS12C, SMS15C, SMS24C

## TYPICAL COMMON ANODE APPLICATIONS

A 5 surge protection junction common anode design in a TSOP-6 package protects four separate lines using only one package. This adds flexibility and creativity to PCB design

especially when board space is at a premium. A simplified example of SMS05C Series Device applications is illustrated below.

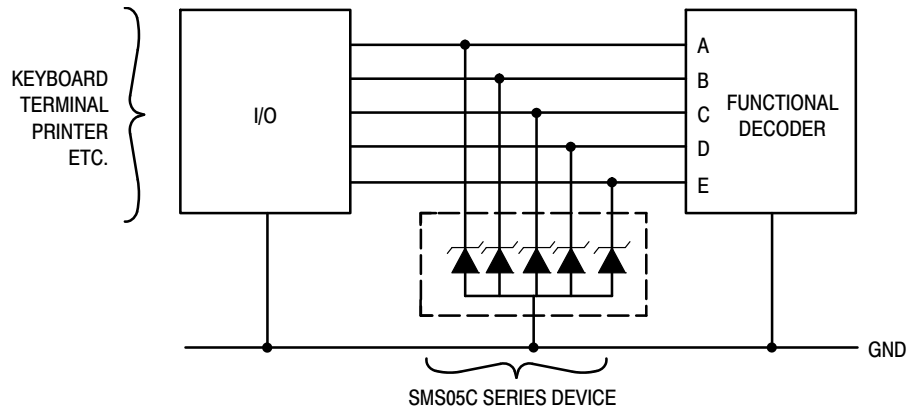

Figure 7. Computer Interface Protection

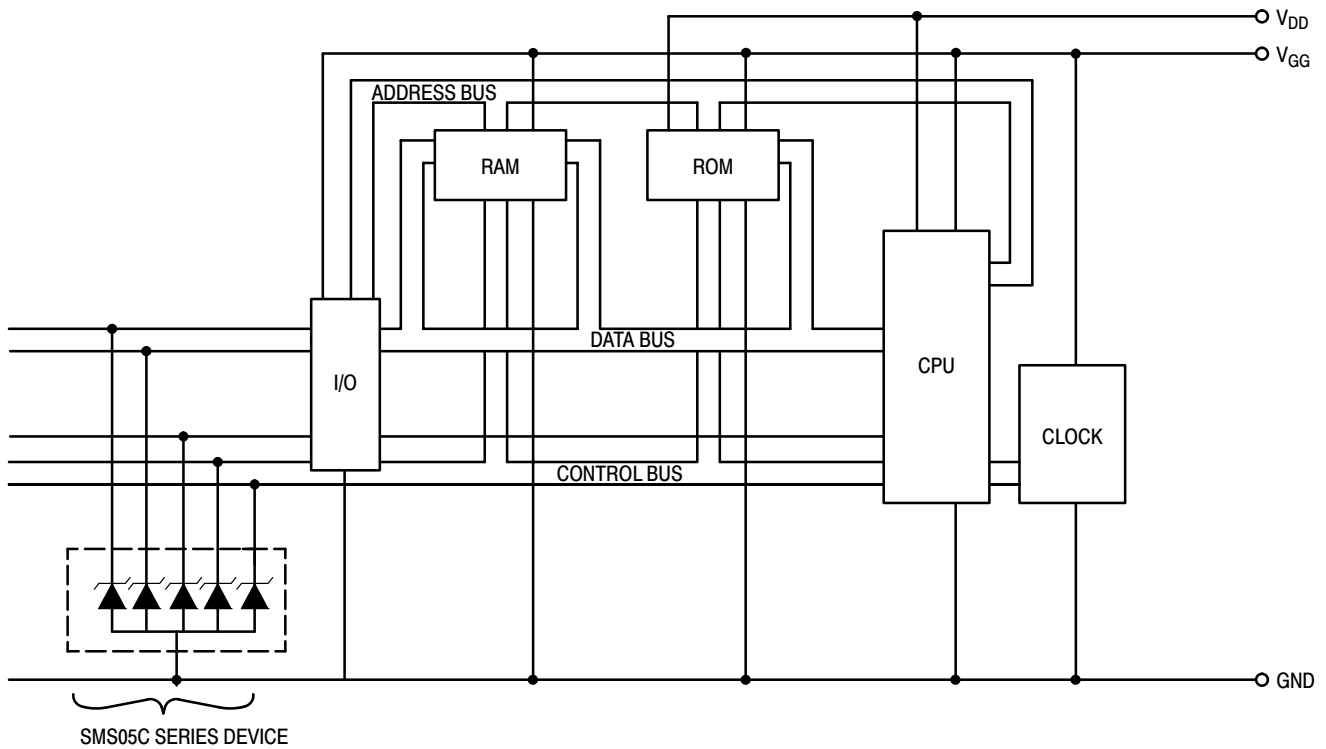

Figure 8. Microprocessor Protection

# MECHANICAL CASE OUTLINE

## PACKAGE DIMENSIONS



**TSOP-6 3.00x1.50x0.90, 0.95P**  
**CASE 318G**  
**ISSUE W**

DATE 26 FEB 2024



**NOTES:**

1. DIMENSIONING AND TOLERANCING PER ASME Y14.5M, 2018.
2. CONTROLLING DIMENSION: MILLIMETERS.
3. MAXIMUM LEAD THICKNESS INCLUDES LEAD FINISH. MINIMUM LEAD THICKNESS IS THE MINIMUM THICKNESS OF BASE MATERIAL.
4. DIMENSIONS D AND E1 DO NOT INCLUDE MOLD FLASH, PROTRUSIONS, OR GATE BURRS. MOLD FLASH, PROTRUSIONS, OR GATE BURRS SHALL NOT EXCEED 0.15 PER SIDE. DIMENSIONS D AND E1 ARE DETERMINED AT DATUM H.
5. PIN 1 INDICATOR MUST BE LOCATED IN THE INDICATED ZONE

MILLIMETERS			
DIM	MIN	NOM	MAX
A	0.90	1.00	1.10
A1	0.01	0.06	0.10
A2	0.80	0.90	1.00
b	0.25	0.38	0.50
c	0.10	0.18	0.26
D	2.90	3.00	3.10
E	2.50	2.75	3.00
E1	1.30	1.50	1.70
e	0.85	0.95	1.05
L	0.20	0.40	0.60
L2	0.25 BSC		
M	0°	---	10°

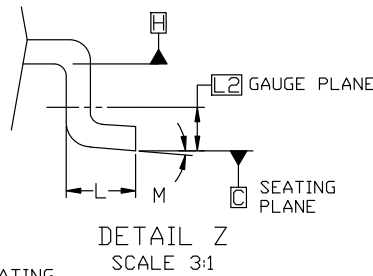

\*For additional information on our Pb-Free strategy and soldering details, please download the ON Semiconductor Soldering and Mounting Techniques Reference manual, SOLDERRM/D.

<b>DOCUMENT NUMBER:</b>	<b>98ASB14888C</b>	Electronic versions are uncontrolled except when accessed directly from the Document Repository. Printed versions are uncontrolled except when stamped "CONTROLLED COPY" in red.
<b>DESCRIPTION:</b>	<b>TSOP-6 3.00x1.50x0.90, 0.95P</b>	<b>PAGE 1 OF 2</b>

onsemi and ONSEMI are trademarks of Semiconductor Components Industries, LLC dba onsemi or its subsidiaries in the United States and/or other countries. onsemi reserves the right to make changes without further notice to any products herein. onsemi makes no warranty, representation or guarantee regarding the suitability of its products for any particular purpose, nor does onsemi assume any liability arising out of the application or use of any product or circuit, and specifically disclaims any and all liability, including without limitation special, consequential or incidental damages. onsemi does not convey any license under its patent rights nor the rights of others.

# MECHANICAL CASE OUTLINE

## PACKAGE DIMENSIONS



TSOP-6 3.00x1.50x0.90, 0.95P  
CASE 318G  
ISSUE W

DATE 26 FEB 2024

### GENERIC MARKING DIAGRAM\*



IC



STANDARD

XXX = Specific Device Code  
A = Assembly Location  
Y = Year  
W = Work Week  
▪ = Pb-Free Package

XXX = Specific Device Code  
M = Date Code  
▪ = Pb-Free Package

\*This information is generic. Please refer to device data sheet for actual part marking. Pb-Free indicator, "G" or microdot "▪", may or may not be present. Some products may not follow the Generic Marking.

STYLE 1:

- PIN 1. DRAIN
- 2. DRAIN
- 3. GATE
- 4. SOURCE
- 5. DRAIN
- 6. DRAIN

STYLE 2:

- PIN 1. EMITTER 2
- 2. BASE 1
- 3. COLLECTOR 1
- 4. EMITTER 1
- 5. BASE 2
- 6. COLLECTOR 2

STYLE 3:

- PIN 1. ENABLE
- 2. N/C
- 3. R BOOST
- 4. Vz
- 5. V in
- 6. V out

STYLE 4:

- PIN 1. N/C
- 2. V in
- 3. NOT USED
- 4. GROUND
- 5. ENABLE
- 6. LOAD

STYLE 5:

- PIN 1. EMITTER 2
- 2. BASE 2
- 3. COLLECTOR 1
- 4. EMITTER 1
- 5. BASE 1
- 6. COLLECTOR 2

STYLE 6:

- PIN 1. COLLECTOR
- 2. COLLECTOR
- 3. BASE
- 4. EMITTER
- 5. COLLECTOR
- 6. COLLECTOR

STYLE 7:

- PIN 1. COLLECTOR
- 2. COLLECTOR
- 3. BASE
- 4. N/C
- 5. COLLECTOR
- 6. EMITTER

STYLE 8:

- PIN 1. Vbus
- 2. D(in)
- 3. D(in)+
- 4. D(out)+
- 5. D(out)
- 6. GND

STYLE 9:

- PIN 1. LOW VOLTAGE GATE
- 2. DRAIN
- 3. SOURCE
- 4. DRAIN
- 5. DRAIN
- 6. HIGH VOLTAGE GATE

STYLE 10:

- PIN 1. D(OUT)+
- 2. GND
- 3. D(OUT)-
- 4. D(IN)-
- 5. VBUS
- 6. D(IN)+

STYLE 11:

- PIN 1. SOURCE 1
- 2. DRAIN 2
- 3. DRAIN 2
- 4. SOURCE 2
- 5. GATE 1
- 6. DRAIN 1/GATE 2

STYLE 12:

- PIN 1. I/O
- 2. GROUND
- 3. I/O
- 4. I/O
- 5. VCC
- 6. I/O

STYLE 13:

- PIN 1. GATE 1
- 2. SOURCE 2
- 3. GATE 2
- 4. DRAIN 2
- 5. SOURCE 1
- 6. DRAIN 1

STYLE 14:

- PIN 1. ANODE
- 2. SOURCE
- 3. GATE
- 4. CATHODE/DRAIN
- 5. CATHODE/DRAIN
- 6. CATHODE/DRAIN

STYLE 15:

- PIN 1. ANODE
- 2. SOURCE
- 3. GATE
- 4. DRAIN
- 5. N/C
- 6. CATHODE

STYLE 16:

- PIN 1. ANODE/CATHODE
- 2. BASE
- 3. EMITTER
- 4. COLLECTOR
- 5. ANODE
- 6. CATHODE

STYLE 17:

- PIN 1. EMITTER
- 2. BASE
- 3. ANODE/CATHODE
- 4. ANODE
- 5. CATHODE
- 6. COLLECTOR

<b>DOCUMENT NUMBER:</b>	<b>98ASB14888C</b>	Electronic versions are uncontrolled except when accessed directly from the Document Repository. Printed versions are uncontrolled except when stamped "CONTROLLED COPY" in red.
<b>DESCRIPTION:</b>	<b>TSOP-6 3.00x1.50x0.90, 0.95P</b>	<b>PAGE 2 OF 2</b>

onsemi and onsemi are trademarks of Semiconductor Components Industries, LLC dba onsemi or its subsidiaries in the United States and/or other countries. onsemi reserves the right to make changes without further notice to any products herein. onsemi makes no warranty, representation or guarantee regarding the suitability of its products for any particular purpose, nor does onsemi assume any liability arising out of the application or use of any product or circuit, and specifically disclaims any and all liability, including without limitation special, consequential or incidental damages. onsemi does not convey any license under its patent rights nor the rights of others.

**onsemi**, **Onsemi**, and other names, marks, and brands are registered and/or common law trademarks of Semiconductor Components Industries, LLC dba "**onsemi**" or its affiliates and/or subsidiaries in the United States and/or other countries. **onsemi** owns the rights to a number of patents, trademarks, copyrights, trade secrets, and other intellectual property. A listing of **onsemi**'s product/patent coverage may be accessed at [www.onsemi.com/site/pdf/Patent-Marking.pdf](http://www.onsemi.com/site/pdf/Patent-Marking.pdf). **onsemi** reserves the right to make changes at any time to any products or information herein, without notice. The information herein is provided "as-is" and **onsemi** makes no warranty, representation or guarantee regarding the accuracy of the information, product features, availability, functionality, or suitability of its products for any particular purpose, nor does **onsemi** assume any liability arising out of the application or use of any product or circuit, and specifically disclaims any and all liability, including without limitation special, consequential or incidental damages. Buyer is responsible for its products and applications using **onsemi** products, including compliance with all laws, regulations and safety requirements or standards, regardless of any support or applications information provided by **onsemi**. "Typical" parameters which may be provided in **onsemi** data sheets and/or specifications can and do vary in different applications and actual performance may vary over time. All operating parameters, including "Typicals" must be validated for each customer application by customer's technical experts. **onsemi** does not convey any license under any of its intellectual property rights nor the rights of others. **onsemi** products are not designed, intended, or authorized for use as a critical component in life support systems or any FDA Class 3 medical devices or medical devices with a same or similar classification in a foreign jurisdiction or any devices intended for implantation in the human body. Should Buyer purchase or use **onsemi** products for any such unintended or unauthorized application, Buyer shall indemnify and hold **onsemi** and its officers, employees, subsidiaries, affiliates, and distributors harmless against all claims, costs, damages, and expenses, and reasonable attorney fees arising out of, directly or indirectly, any claim of personal injury or death associated with such unintended or unauthorized use, even if such claim alleges that **onsemi** was negligent regarding the design or manufacture of the part. **onsemi** is an Equal Opportunity/Affirmative Action Employer. This literature is subject to all applicable copyright laws and is not for resale in any manner.

## ADDITIONAL INFORMATION

### TECHNICAL PUBLICATIONS:

Technical Library: [www.onsemi.com/design/resources/technical-documentation](http://www.onsemi.com/design/resources/technical-documentation)  
onsemi Website: [www.onsemi.com](http://www.onsemi.com)

### ONLINE SUPPORT: [www.onsemi.com/support](http://www.onsemi.com/support)

For additional information, please contact your local Sales Representative at [www.onsemi.com/support/sales](http://www.onsemi.com/support/sales)