

**STRICTLY
CONFIDENTIAL**

DRAWING NUMBER FSA 307934 REVISION A SHEET 1/1 APPROVAL LEVEL
 NUMERO DISEGNO FSA 307934 REVISIONE A FOGLIO 1/1 LIV. DI APPROVAZIONE
 DISEGNO C

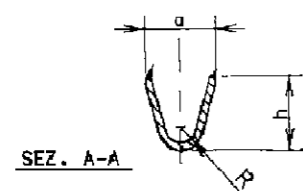

SEZ. A-A

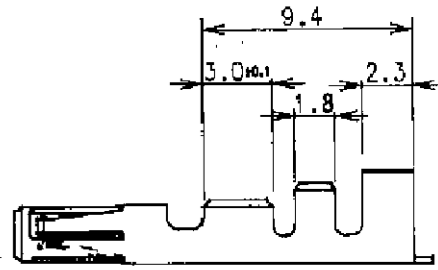
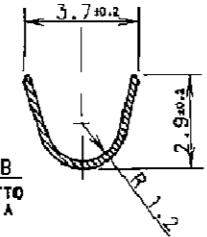

SEZ. B-B
PER CONTATTO
VERSIONE A

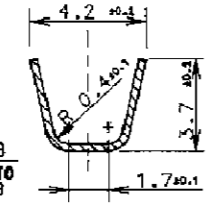
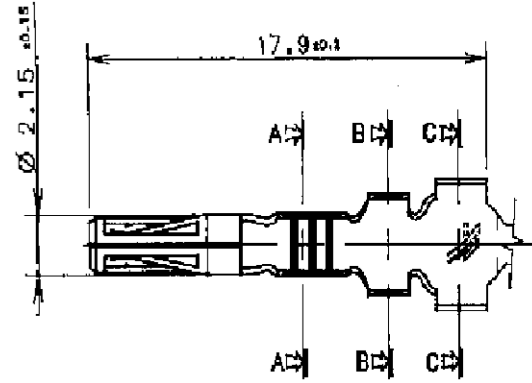

SEZ. B-B
PER CONTATTO
VERSIONE B

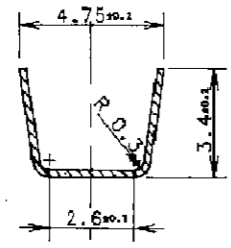

SEZ. C-C

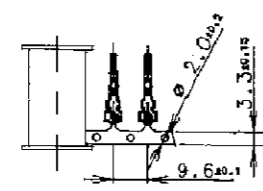

NOTE :

MATERIALE : BRONZO FOSFOROSO PRESTAGNATO
 CONTATTO ADATTO PER ISOLANTE RIDOTTO FASE 3
 SECONDO SPEC. FIAT 91107/03

MVL PART NUMBER	REV.	DELPHI PART NUMBER	REV.
HC3FBS1PT	A	15363897	01
HC3FBS2PT	A	15363896	01

VERSIONE	RANGO FILO	CATALOGO N°	a ± 0.2	h ± 0.2	R ± 0.1
A	0.35±0.5 mm²	HC3FBS1PT	2.3	2.3	0.5
B	0.75±1.0 mm²	HC3FBS2PT	3.2	3.2	0.8

14-07742	25-09-2014	A	-	Updated format and added DELPHI P/Ns	F.G.	M.C.	
ECN-NO. NUMERO -ECN	DATE DD/ MM / YY DATA	REVISION REVISIONE	POSITION POSIZIONE	CHANGE DESCRIPTION DESCRIZIONE MODIFICA	DRAWN BY DISEGNATORE	CHK. BY CONTROLLATO	APPR. BY APPROVATO
PRODUCT SPEC. SPEC. DI PRODOTTO	PACKAGING SPEC. SPEC. DI IMBALLAGGIO	APPLICATION SPEC. SPEC. DI APPLICAZIONE	COPYRIGHT DELPHI CORPORATION AND/OR ITS AFFILIATES. ALL RIGHTS RESERVED. REVISED THIS DRAWING IS THE PROPERTY OF DELPHI CORPORATION. THE REPRODUCTION, DISTRIBUTION AND UTILIZATION OF THIS DOCUMENT OR ITS RELATED CAD DATA, AS WELL AS COMMUNICATION OF ANY CONTENT TO OTHERS, WITHOUT EXPRESS AUTHORIZATION IS PROHIBITED.				
TOLERANCES TOLLERANZE ± 0.3mm / ±2°	COUNTERPART Nr. CONTROPARTE Nr.	MATERIAL : MATERIALE : SEE TABLE	COLOUR : COLORE : TOOL NO. -	SURFACE FINISH FINITURA SUPERFICIALE -	DELPHI DELPHI PACKARD ELECTRICAL/ELECTRONIC ARCHITECTURE TORINO, ITALY		CAD SYSTEM pro / eng.
DO NOT SCALE DRAWING DISEGNO FUORI SCALA	DATE DATA	NAME NOME	TITLE DESCRIZIONE	LOC. CODE NAZIONALITA' IT	C ISO PROJECTION PROIEZIONE ISO	DIMENSION IN MILLIMETERS DIMENSIONI IN MILLIMETRI	DWG SIZE FORMATO A4
DRAWN BY DISEGNATORE	08-04-99	R.P.	HC3 FEMALE CONTACT		DRAWING NUMBER NUMERO DISEGNO		SHEET FOGLIO
CHECKED BY CONTROLLATO					FSA 307934		1 of 1 di
APPROVED BY APPROVATO	08/04/99	P.C.B.	ESR NO. NUMERO ESR	EU -	CAT. NO. NUMERO CAT.	SEE TABLE	FILE NAME NOME FILE
						FSA 307934	SCALE SCALA -

Mouser Electronics

Authorized Distributor

Click to View Pricing, Inventory, Delivery & Lifecycle Information:

[Aptiv:](#)

[15363897](#) [15363897-L](#)