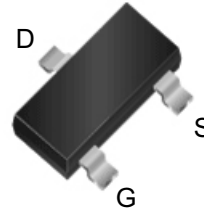
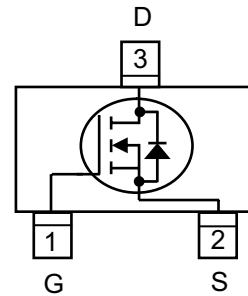

**WNM4009**
**Single N-Channel, 110V, 1.7A, Power MOSFET**
[Http://www.sh-willsemi.com](http://www.sh-willsemi.com)

V <sub>DS</sub> (V)	Typical R <sub>ds(on)</sub> (Ω)
110	0.235@ V <sub>GS</sub> =10V
	0.260@ V <sub>GS</sub> =4.5V

**SOT-23**

**Pin configuration (Top view)**
**Descriptions**

The WNM4009 is N-Channel enhancement MOS Field Effect Transistor. Uses advanced trench technology and design to provide excellent R<sub>DS(ON)</sub> with low gate charge. This device is suitable for use in DC-DC conversion, power switch and charging circuit. Standard Product WNM4009 is Pb-free and Halogen-free.

**Features**

- Trench Technology
- Supper high density cell design
- Excellent ON resistance for higher DC current
- Small package SOT-23

**Applications**

- Driver for Relay, Solenoid, Motor, LED etc.
- DC-DC converter circuit
- Power Switch
- Load Switch
- Charging

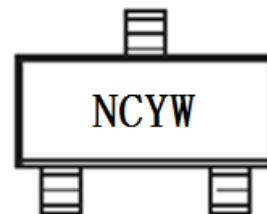

**NC** = Device Code  
**Y** = Year  
**W** = Week

**Marking**
**Order information**

Device	Package	Shipping
WNM4009-3/TR	SOT-23	3000/Reel&Tape

**Absolute Maximum ratings**

Parameter		Symbol	1S	10 S	Steady State	Unit
Drain-Source Voltage		$V_{DS}$	110			V
Gate-Source Voltage		$V_{GS}$	$\pm 20$			
Continuous Drain Current <sup>a d</sup>	$T_A=25^\circ\text{C}$	$I_D$	2.03	1.70	1.45	A
	$T_A=70^\circ\text{C}$		1.62	1.36	1.16	
Maximum Power Dissipation <sup>a d</sup>	$T_A=25^\circ\text{C}$	$P_D$	2.27	1.60	1.15	W
	$T_A=70^\circ\text{C}$		1.45	1.02	0.74	
Continuous Drain Current <sup>b d</sup>	$T_A=25^\circ\text{C}$	$I_D$	1.88	1.50	1.34	A
	$T_A=70^\circ\text{C}$		1.5	1.20	1.07	
Maximum Power Dissipation <sup>b d</sup>	$T_A=25^\circ\text{C}$	$P_D$	1.95	1.25	1.00	W
	$T_A=70^\circ\text{C}$		1.25	0.80	0.64	
Pulsed Drain Current <sup>c</sup>		$I_{DM}$	7			A
Operating Junction Temperature		$T_J$	-55 to 150			$^\circ\text{C}$
Lead Temperature		$T_L$	260			$^\circ\text{C}$
Storage Temperature Range		$T_{stg}$	-55 to 150			$^\circ\text{C}$

**Thermal resistance ratings**

Parameter		Symbol	Typical	Maximum	Unit
Junction-to-Ambient Thermal Resistance <sup>a</sup>	$t \leq 1 \text{ s}$	$R_{\theta JA}$	40	55	$^\circ\text{C/W}$
	$t \leq 10 \text{ s}$		60	78	
	Steady State		88	108	
Junction-to-Ambient Thermal Resistance <sup>b</sup>	$t \leq 1 \text{ s}$	$R_{\theta JA}$	50	64	
	$t \leq 10 \text{ s}$		85	100	
	Steady State		105	125	
Junction-to-Case Thermal Resistance		Steady State	$R_{\theta JC}$	60	75

a Surface mounted on FR-4 Board using 1 square inch pad size, 1oz copper

b Surface mounted on FR-4 board using minimum pad size, 1oz copper

c Pulse width < 380 $\mu\text{s}$ , Duty Cycle < 2%

d Maximum junction temperature  $T_J=150^\circ\text{C}$ .

**Electronics Characteristics (Ta=25°C, unless otherwise noted)**

Parameter	Symbol	Test Conditions	Min	Typ	Max	Unit
<b>OFF CHARACTERISTICS</b>						
Drain-to-Source Breakdown Voltage	$BV_{DSS}$	$V_{GS} = 0V, I_D = 250\mu A$	110			V
Zero Gate Voltage Drain Current	$I_{DSS}$	$V_{DS} = 90V, V_{GS} = 0V$			1	$\mu A$
Gate-to-source Leakage Current	$I_{GSS}$	$V_{DS} = 0V, V_{GS} = \pm 20V$			$\pm 100$	nA
<b>ON CHARACTERISTICS</b>						
Gate Threshold Voltage	$V_{GS(TH)}$	$V_{GS} = V_{DS}, I_D = 250\mu A$	1	1.9	2.5	V
Drain-to-source On-resistance <sup>b, c</sup>	$R_{DS(on)}$	$V_{GS} = 10V, I_D = 1.5A$		235	310	m $\Omega$
		$V_{GS} = 4.5V, I_D = 1.3A$		260	350	
Forward Trans conductance	$g_{fs}$	$V_{DS} = 10V, I_D = 3A$		1.1		S
<b>CAPACITANCES, CHARGES</b>						
Input Capacitance	$C_{ISS}$	$V_{GS} = 0V,$ $f = 1.0\text{ MHz},$ $V_{DS} = 25V$		317		pF
Output Capacitance	$C_{OSS}$			28		
Reverse Transfer Capacitance	$C_{RSS}$			14		
Total Gate Charge	$Q_{G(TOT)}$	$V_{GS} = 10V,$ $V_{DD} = 80V,$ $I_D = 1.5A$		7.5		nC
Threshold Gate Charge	$Q_{G(TH)}$			0.7		
Gate-to-Source Charge	$Q_{GS}$			1.1		
Gate-to-Drain Charge	$Q_{GD}$			2.1		
<b>SWITCHING CHARACTERISTICS</b>						
Turn-On Delay Time	$t_d(ON)$	$V_{GS} = 10V,$ $V_{DD} = 50V,$ $R_L = 50\Omega,$ $R_G = 3.3\Omega$		11.8		ns
Rise Time	$t_r$			13.2		
Turn-Off Delay Time	$t_d(OFF)$			32.8		
Fall Time	$t_f$			4.8		
<b>BODY DIODE CHARACTERISTICS</b>						
Forward Voltage	$V_{SD}$	$V_{GS} = 0V, I_S = 1A$		0.8	1.2	V

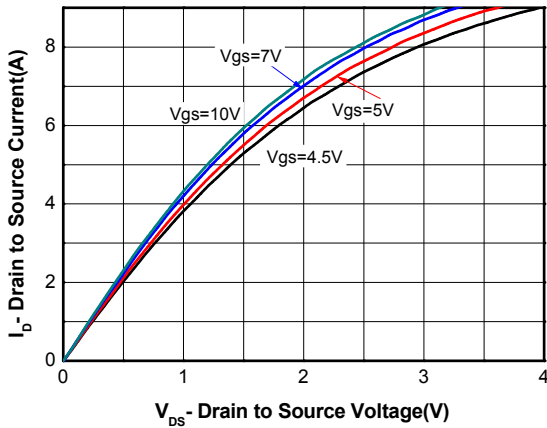
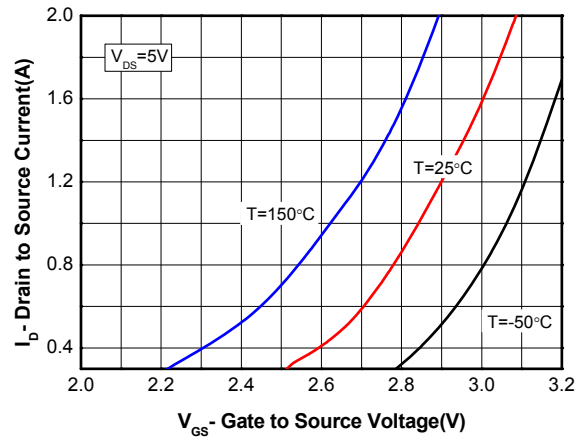
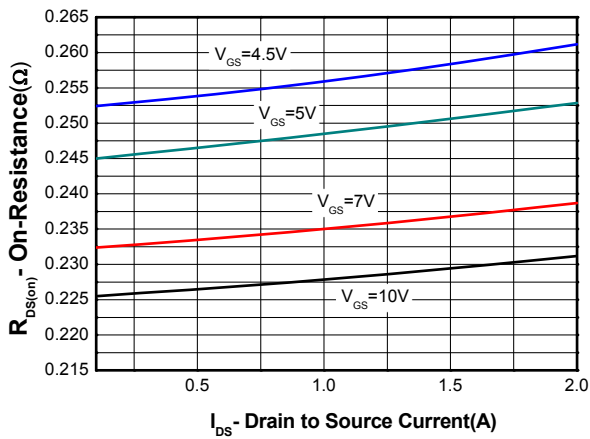
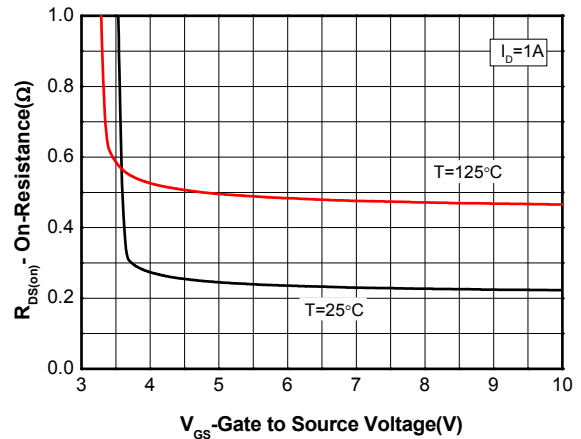
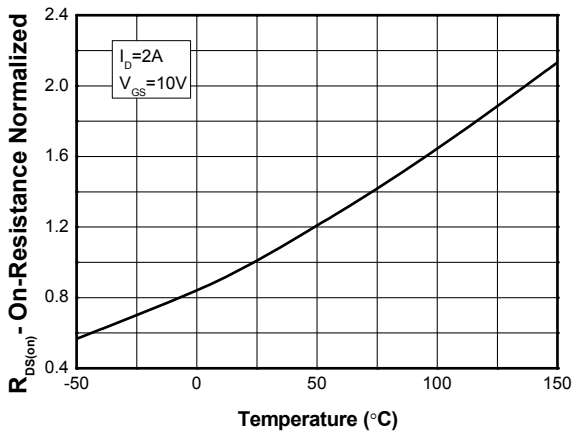
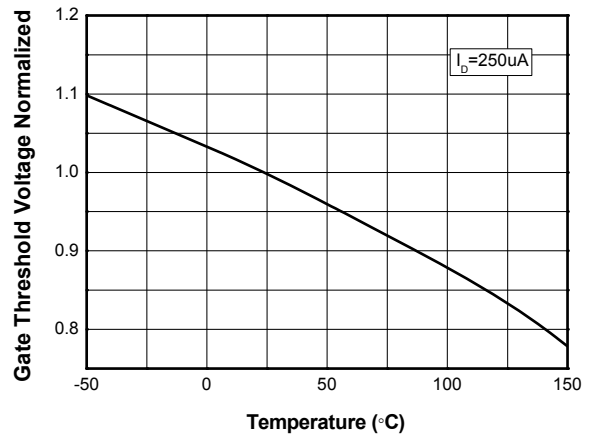
**Typical Characteristics (Ta=25°C, unless otherwise noted)**

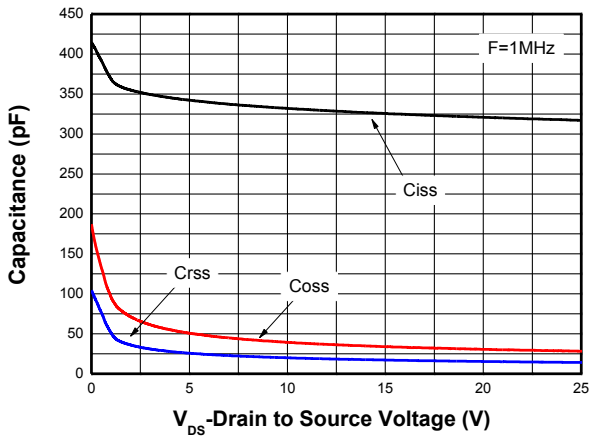
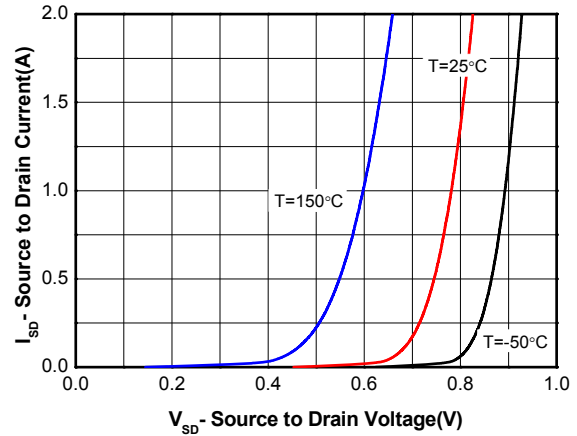
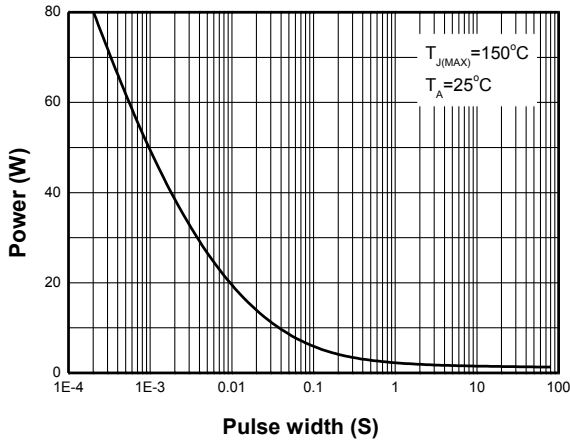
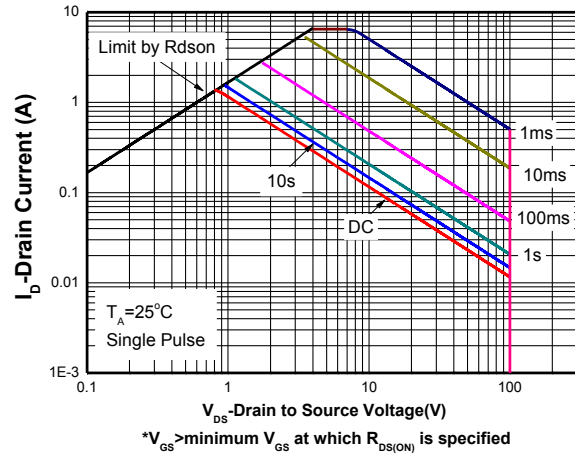
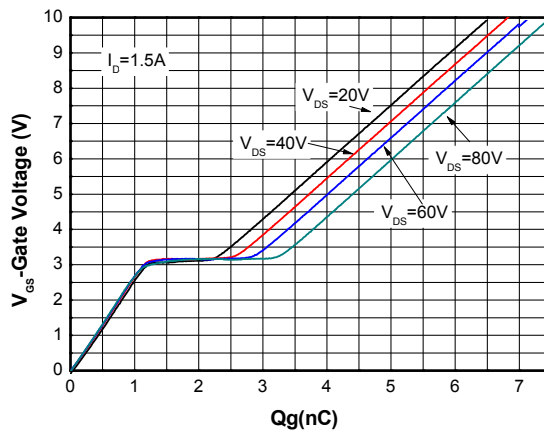
**Output characteristics**

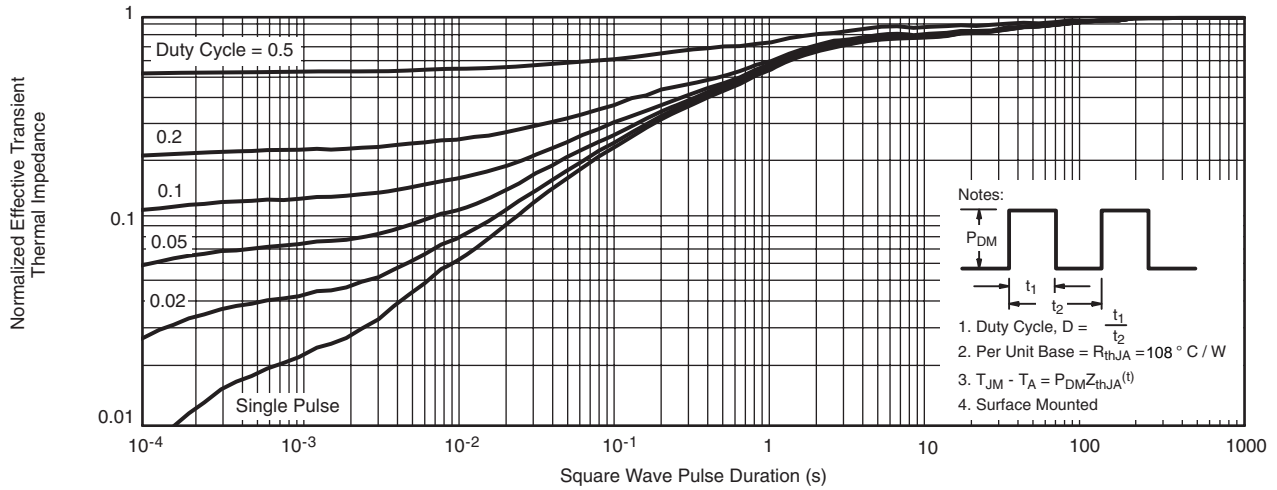
**Transfer characteristics**

**On-Resistance vs. Drain current**

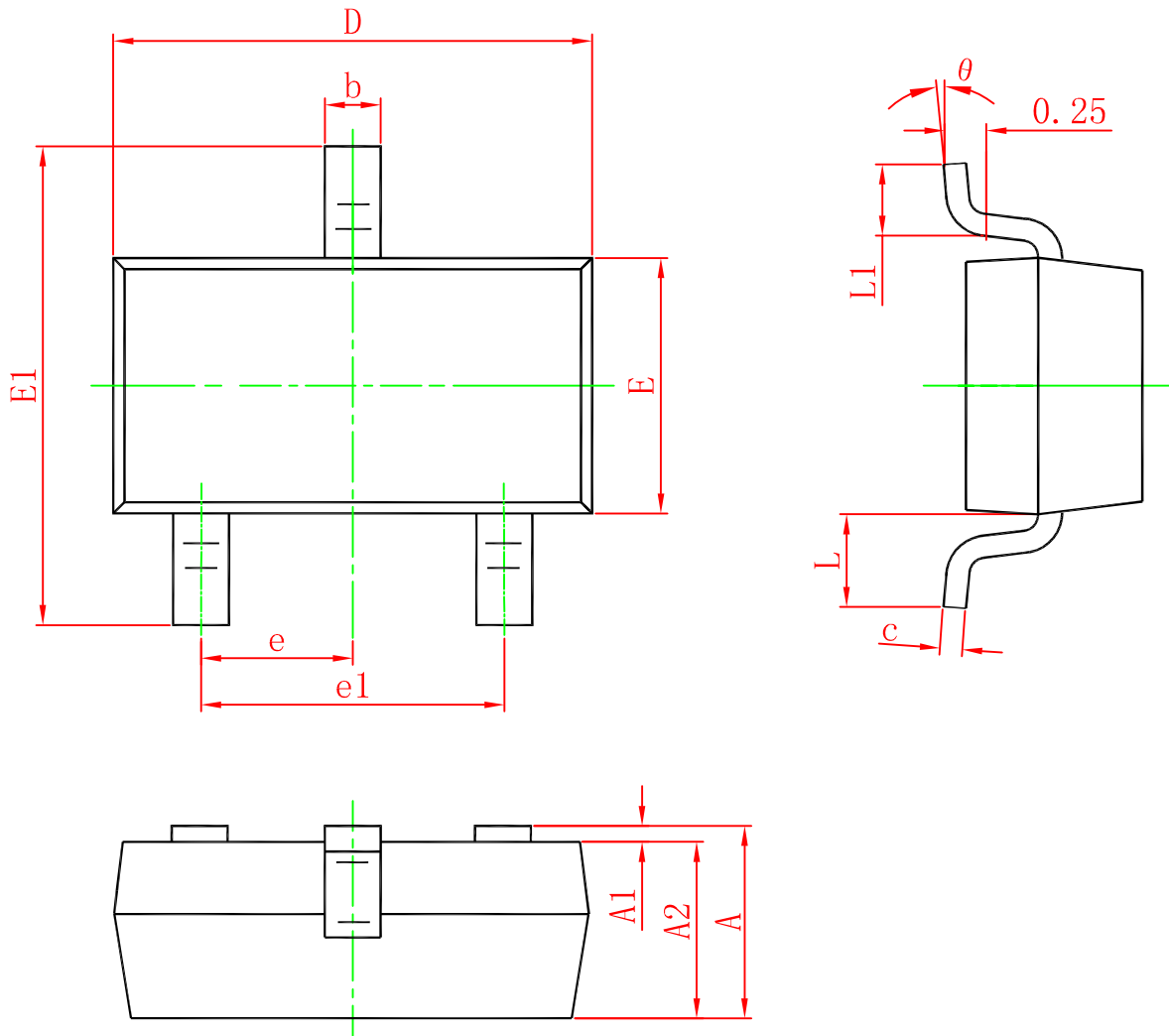
**On-Resistance vs. Gate-to-Source voltage**

**On-Resistance vs. Junction temperature**

**Threshold voltage vs. Junction temperature**



**Capacitance**

**Body diode forward voltage**

**Single pulse power**

**Safe operating power**

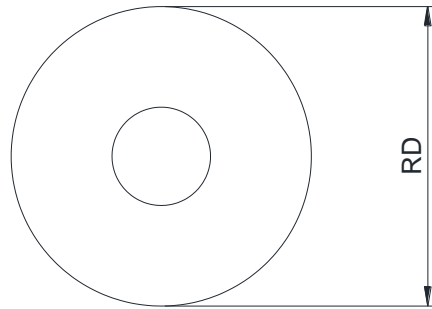
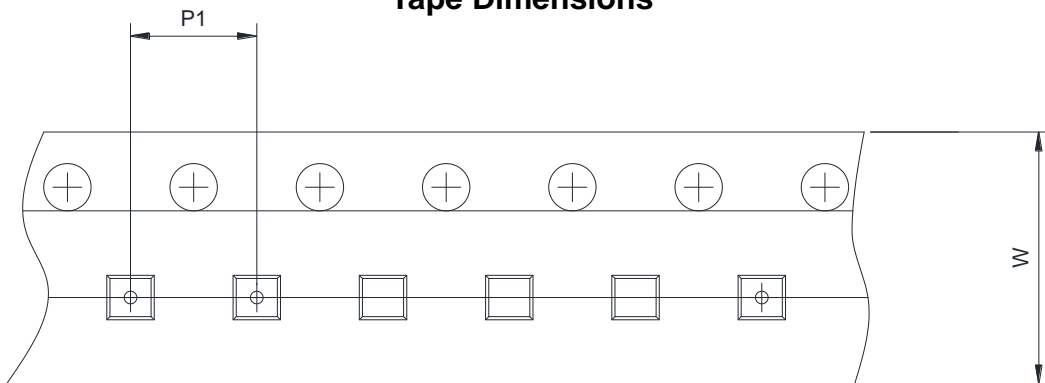
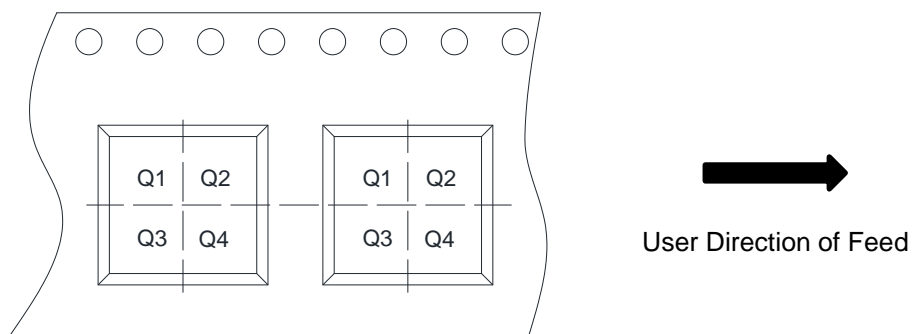
**Gate charge Characteristics**



**Transient thermal response (Junction-to-Ambient)**

**Package outline dimensions**
**SOT-23**

Symbol	Dimensions In Millimeters	
	Min.	Max.
A	0.900	1.150
A1	0.000	0.100
A2	0.900	1.050
b	0.300	0.500
c	0.080	0.150
D	2.800	3.000
E	1.200	1.400
E1	2.250	2.550
e	0.950 (Typ.)	
e1	1.800	2.000
L	0.550 (Typ.)	
L1	0.300	0.500
$\theta$	0°	8°

**APE AND REEL INFORMATION**
**Reel Dimensions**

**Tape Dimensions**

**Quadrant Assignments For PIN1 Orientation In Tape**

RD	Reel Dimension	<input checked="" type="checkbox"/> 7inch	<input type="checkbox"/> 13inch
W	Overall width of the carrier tape	<input checked="" type="checkbox"/> 8mm	<input type="checkbox"/> 12mm <input type="checkbox"/> 16mm
P1	Pitch between successive cavity centers	<input type="checkbox"/> 2mm	<input checked="" type="checkbox"/> 4mm <input type="checkbox"/> 8mm
Pin1	Pin1 Quadrant	<input type="checkbox"/> Q1	<input type="checkbox"/> Q2 <input checked="" type="checkbox"/> Q3 <input type="checkbox"/> Q4