

SAMZO REAC/ROHS

REV	ECN NO	DESCRIPTION	DESIGN	APPROVAL	DATE
A1	NEW	Replace frame			2018.06.12

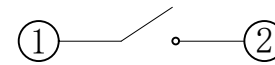
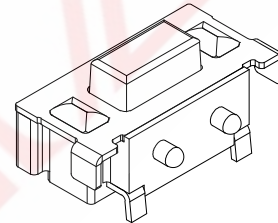
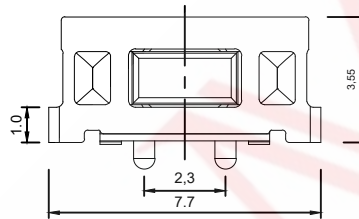
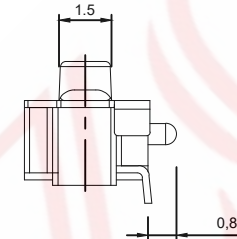
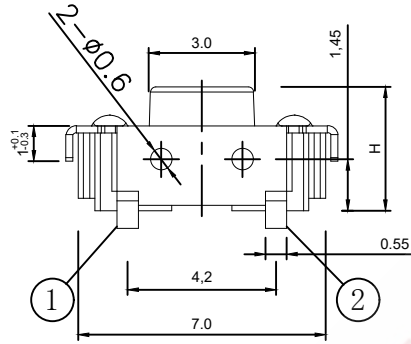
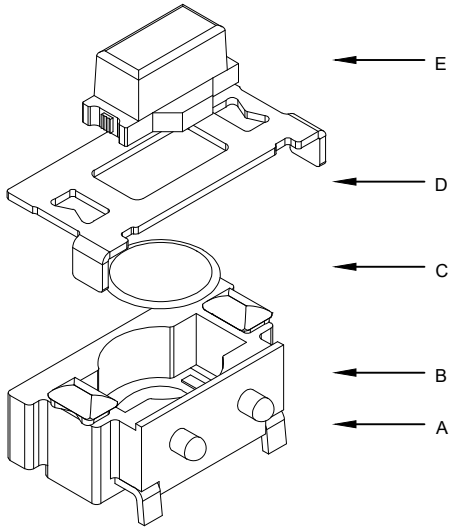

电路图  
CIRCUIT DIAGRAM

主要技术参数、性能  
The Main Thchnology Performance

额定电流、电压 Rate voltage, current	50mA DC12V
接触电阻 Contact resistance	≤100mΩ
按力 Operating force	±50gf
行程 Travel	0.20±0.10mm
绝缘电阻 Insulated resistance	≥100MΩ
介电强度 Dielectric strength	≥250VAC/1min

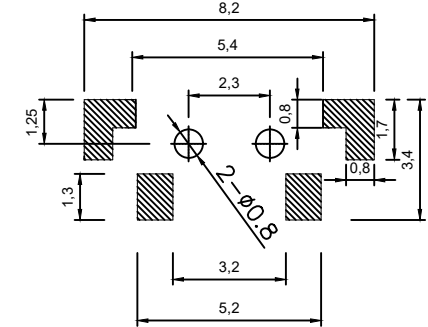

PCB. 焊接图  
PCB. WELDING DRAWING

- T 5 B \* \* \* \* 1 0
- A B C D E F G H

- A. 系列:T-3\*6mm系列
- B. 贴装方式:5-卧式贴片
- C. 引脚规格:B-4P
- D. 操作高度:32-3.2/35-3.5/38-3.8mm
- E. 操作力度:1-120/2-180/3-260gf
- F. 操作寿命:1-20,000次/2-50,000次
- G. 固定方式:2-带住
- H. 物料编码:0-常规

ITEM	DESCRIPTION	MATERIAL	QTY	FINISH/COLOR				
E	按钮	PPA	1	黑色	GENERAL TOLERANCE			
D	盖板	黄铜	1	镀银	≥0~2<	±0.15	SCALE 1:1 UNIT mm	
C	弹片	不锈钢	1	镀银	DESIGN WANGUIFA	2018.06.12	≥2~5<	±0.25
B	本件	LCP	1	白色	CHECKED ZHENGUILAN	2018.06.12	≥0~2<	±0.15
A	卡件	黄铜	1	镀银	APPROVED LILIANJIANG	2018.06.14	≥5	±0.35

FIRST VIEW

The copyright belongs to samzo parts [China] Co., Ltd. please use the material after samzo parts agree to authorize. The final right of interpretation belongs to samzo parts. WWW.KKK-JP.COM

**SAMZO COMPONENTS**  
Electronic switch and connector manufacturer

TITLE::	3*6*H mm 4P-WT
DWG NO:	T5B35-P26
PART NO:	T5B353172
MODEL NO:	T5B-**-**-20
NAME:	TACT SWITCH