

## OVERVIEW

## TEMPERATURE CONTROLLERS









- *Ecological*
- *Reliable*
- *Highest quality*
- *Cost-saving*



# Content

Panasonic temperature controllers. . . . .	2	Specifications . . . . .	18
Temperature controllers overview. . . . .	4	Parts and functions. . . . .	19
KT2. . . . .	6	Communication. . . . .	20
KT4. . . . .	8	KT-Monitor software . . . . .	21
KT4H / 4B. . . . .	10	Dimensions. . . . .	22
KT7. . . . .	12	Accessories . . . . .	24
KT8. . . . .	14	Application examples . . . . .	26
KT9. . . . .	16	Further Panasonic products . . . . .	27

# Overview

Dimensions W x H x D (mm)	Display character height (mm)						
	PV: SV:	8.7 8.7	12 6	10.2 8.8	7.4 7.4	11.2 11.2	18.2 13.2
96 x 96 x 98.5							 <b>KT9</b> Big display
48 x 96 x 98.5						 <b>KT8</b> Easy readable display	
22.5 x 75 x 100				 <b>KT7</b> Din rail			
48 x 48 x 95			 <b>KT4</b> high performance				
48 x 48 x 62		 <b>KT4H/KT4B</b> 11 segment LCD display					
48 x 24 x 98.5	 <b>KT2</b> Nine step pattern control						









## Common features

- Multi-input: Versatile thermocouple, RTD, DC current, DC voltage
- Control modes: PID, on/off control, Anti-Reset-Windup (ARW)
- Control output: Relay, non-contact voltage output  
(for SSR drive, DC output)
- Accuracy:  $\pm 0.2\%$  span
- Simple operation
- Heater-burn-out alarm available
- Alarm output with 9 different operation modes
- RS485 ASCII/Modbus communication available
- Supply voltage: 24VAC/DC or 100 to 240VAC
- Compliant with UL, CSA standards and CE marking

## Output types

Output method	Characteristics
Relay contact output	Relay contact output is used for switching up to 3A 250 VAC (resistive load) in applications in which the on-off frequency is low.
Voltage output for SSR drive	This voltage output is used for driving the SSR. Since the SSR is a semiconductor relay, contact life is long. This type is used in applications in which the on-off frequency is high. Up to 40mA 12VDC can be switched.
DC current output	This current output is used to control a power regulator. Smooth and accurate control is possible because phase control corresponds to the current output.

# Selection of products

Model		KT2	KT4	KT4H / KT4B	KT7	KT8	KT9
							
Dimensions (W x H x D)		48 x 24 x 98.5mm	48 x 48 x 95mm	48 x 48 x 62mm	22.5 x 75 x 100mm	48 x 96 x 98.5mm	96 x 96 x 98.5mm
Protection		IP66 (applicable only to the front panel subject to rubber gasket employed) <b>except for KT7</b>					
Output type		Output range					
Control output	Relay contact	1a	1a	1a1b	1a	1a1b	1a1b
	DC voltage	3A 250VAC (resistive load), 1A 250VAC (inductive load $\cos\phi=0.4$ ), electric life: 100,000 times					
	DC current	12 - 14VDC; max. load current: 40mA (short-circuit protected)					
Input type		Input range					
Thermocouple	K	-200 to 1370°C					
		-199.9 to 400°C					
	J	-200 to 1000°C					
	R	0 to 1760°C					
	S	0 to 1760°C					
	B	0 to 1820°C					
	E	-200 to 800°C					
	T	-199.9 to 400°C	-200 to 400°C				-199.9 to 400°C
	N	-200 to 1300°C					
PL-II	-200 to 1390°C						
C (W/Re5-26)	0 to 2315°C						
RTD	Pt100	-200 to 850°C					
		-199.9 to 850°C	-200 to 850°C				-199.9 to 850°C
	JPt100	-200 to 500°C					
	3-conductor system	-199.9 to 500°C	-200 to 500°C				-199.9 to 500°C
DC current	4 to 20mA DC	-1999 to 9999, -199.9 to 999.9					-1999 to 9999, -199.9 to 999.9
	0 to 20mA DC	-19.99 to 99.99, -1.999 to 9.999					-19.99 to 99.99, -1.999 to 9.999
DC voltage	0 to 1VDC	<ul style="list-style-type: none"> <li>Scaling and change to the decimal point position is possible for DC current and DC voltage input.</li> <li>DC current input is supported with an externally mounted 50Ω shunt resistor (sold separately).</li> </ul>		-2000 to 10,000	<ul style="list-style-type: none"> <li>Scaling and change to the decimal point position is possible for DC current and DC voltage input.</li> <li>DC current input is supported with an externally mounted 50Ω shunt resistor (sold separately).</li> </ul>		
	0 to 10VDC						
	1 to 5VDC						
	0 to 5VDC						
Control mode		Actions mentioned below can be selected by key operation. [Default PID] PID (with auto-tuning function), PI, PD (with manual reset function), P (with manual reset function), ON/OFF action					
Supply voltage (must be specified)		100 to 240VAC 24VAC/DC					
Communication function		RS485/MODBUS Protocol (MODBUS is a communication protocol developed for PLCs by Modicon Inc.) communication speed: 2400/4800/9600/19200bps					
Standards	EMC directives	EN61000-6-4/EN61000-6-2					
	Low-voltage directives	EN61010-1/IEC61010-1					

Further specifications see page 19.



# KT2

## Tiny size - pattern control



- 1/32 DIN size temperature controller
- Size 48x24x95.5mm (WxHxD)
- 9-step pattern control (ramp function)
- Panel-mounted type
- IP66 waterproof (front side if panel mounted)
- 2 set values possible (externally selectable)
- 2nd optional alarm output
- Heating and cooling control with 2nd optional control output (relay)
- Analogue value converter function

### Product types

Base model	Power supply	Sensor input	Control output	Alarm output	Heating/cooling control	Heater burnout alarm	Communication function	Description
AKT2								48x24x98.5mm
	1							100 to 240VAC
	2							24VAC/DC
		1						Multi-input (thermocouple, RTD, DC current and DC voltage)
			1					Relay contact output 1a 3A 250VAC
			2					Non-contact voltage output (for SSR drive)
			3					Current output
				2	0	0	Blank	When neither the heating/cooling nor the communication function is added: Relay contact output (alarm 1): Can be used Open collector output (alarm 2): Can be used
				1	1	0	Blank	When only the heating/cooling function is added: Relay contact output (alarm 1): Cannot be used Open collector output (alarm 2): Can be used
				1	0	0	1	When only the communication function is added: Relay contact output (alarm 1): Can be used Open collector output (alarm 2): Cannot be used
				0	1	0	1	When both the heating/cooling and the communication functions are added: Relay contact output (alarm 1): Cannot be used Open collector output (alarm 2): Cannot be used

Note: When heating/cooling is selected, alarm output 1 cannot be used. When the communication function is selected, alarm output 2 cannot be used.

### Model No.

(Ex) Model No. when the optional functions (of heating/cooling control: relay contact output + communications function) is added on to the basic model is as follows; Model No.: AKT21110101

The optional functions are only the following four patterns:

AKT2□1□200 Blank; AKT2□1□110 Blank; AKT2□1□1001; AKT2□1□0101

### Options

Product name	Model No.
Shunt resistor (for current input)	AKT4810
Terminal cover	AKT2801

Note: When a current input is specified, a shunt resistor (sold separately) is required.





# KT4

## Small-sized standard type



- 1/16 DIN size temperature controller
- Size 48x48x95mm (WxHxD)
- Panel-mounted type
- IP66 waterproof (frontside if panel mounted)
- 2nd optional alarm output
- Heating and cooling control with 2nd optional control output (non-contact voltage output)

### Product types

Base model	Power supply	Sensor input	Control output	Alarm output	Heating/cooling control	Heater burnout alarm	Communication function	Description
AKT4								48x48x95mm
	1							100 to 240VAC
	2							24VAC/DC
		1						Multi-input (thermocouple, RTD, DC current and DC voltage)
			1					Relay contact output 1a 3A 250VAC
			2					Non-contact voltage output (for SSR drive)
			3					Current output
				1				Relay contact output 1a (alarm output 1)
				2				Relay contact output 1a (alarm output 2)
					0			Not available
					4			SSR output 0.3A 250VAC (heating/cooling control not supported when alarm output 2 is selected)
						0		Not available
						1		5A (heater burn-out alarm not supported when control output is current output type/not supported when heating and cooling control is selected)
						2		10A (heater burn-out alarm not supported when control output is current output type/not supported when heating and cooling control is selected)
						3		20A (heater burn-out alarm not supported when control output is current output type/not supported when heating and cooling control is selected)
						4		50A (heater burn-out alarm not supported when control output is current output type/not supported when heating and cooling control is selected)
								Not available
							1	Available

- 1.) CT1 or CT2 for current detection is provided as an accessory when heater burn-out alarm function is added.  
 2.) Event output will be shared if you choose alarm output 2 and the heater burn-out alarm.

### Model No.

(Ex) Model No. when the optional functions (of heating/cooling control: SSR output + communications function) is added on to the basic model is as follows; Model No.: AKT41111401

### Options

Product name	Model No.
Shunt resistor (for current input)	AKT4810
Terminal cover	AKT4801

Product name	Description	Model No.
Installation frame	For KT4, KT4H and KT4B	AKW4822

Note: When a current input is specified, a shunt resistor (sold separately) is required.



# KT4H/4B

## Small-sized standard type



- 1/16 DIN size temperature controller
- Size 48x48x62 (WxHxD)
- Panel-mounted type
- IP66 waterproof (frontside if panel mounted)
- 2nd optional alarm output
- Heating and cooling control with optional control output (non-contact voltage output)

### Product Types

Base model	Power supply	Sensor input	Control output	Alarm output	Heating/cooling control	Heater burnout alarm	Communication function	Description	
AKT4H/-B								48 x 48 x 62mm	
	1							100 to 240VAC	
	2							24VAC/DC	
			1					Multi-input (Thermocouple, RTD, DC current and DC voltage)	
				1				Relay contact output 1a 3A 250VAC	
				2				Non-contact voltage (for SSR drive)	
				3			0	DC current <b>Heater burn-out alarm not possible</b>	
					1			1 point (1a)	
					2	0		2 points (1a + 1a) <b>Heating/cooling control output not possible</b>	
						0		Not available	
						1	0	Relay contact <b>Heater burn-out alarm not possible</b>	
						2	0	Non-contact voltage (for SSR drive) <b>Heater burn-out alarm not possible</b>	
							0	Not available	
				1 or 2		0	3	Single phase 20A (heater burn-out alarm not supported when control output is DC output type/not supported when heating and cooling control is selected)	
				1 or 2		0	4	Single phase 50A (heater burn-out alarm not supported when control output is DC output type/not supported when heating and cooling control is selected)	
				1 or 2		0	5	Three phase 20A (heater burn-out alarm not supported when control output is DC output type/not supported when heating and cooling control is selected)	
				1 or 2		0	6	Three phase 50A (heater burn-out alarm not supported when control output is DC output type/not supported when heating and cooling control is selected)	
								Blank	Not available
								1	Serial communication RS485
								2	Contact input

1.) CT1 or CT2 for current transformer is provided as an accessory when heater burn-out alarm function is added.

2.) Under some conditions, option functions (shaded items) may not be available; please check the description in the table above for details.

### Model No.

(Ex) Model No. when the optional functions (heating/cooling control + communication function) are added on to the basic model is as follows; Model No.: AKT4H1111101 / AKT4B111100

### Options

Product name	Model No.
Shunt resistor (for current input)	AKT4810
Terminal cover	AKT4H801
Tool cable	AKT4H820
Installation frame for KT4, KT4H/-B	AKW4822

### Setting software

Product name	Description
KT monitor	Editing of all types of data, file saving, monitoring of readings, Saving of log files

Note: Please download user manual from our website.



# KT7

## Slim rail-mounting type

- Size 22.5x75x100mm (WxHxD)
- Front screw terminals
- DIN rail mounting type
- Alarm output
- Analogue value converter function



### Product Types

Base model	Power supply	Sensor input	Control output	Alarm output	Heating/cooling control	Heater burnout alarm	Communication function	Description
AKT7								22.5x75x100mm
	1							100 to 240VAC
	2							24VAC/DC
		1						Multi-input (thermocouple, RTD, DC current and DC voltage)
			1					Relay contact output 1a 3A 250VAC
			2					Non-contact voltage output (for SSR drive)
			3					Current output
				1				Open collector output (alarm output 1)
					0			Not available (without heating/cooling function)
						0		Not available
						1		5A (not available for current output type) open collector output
						2		10A (not available for current output type) open collector output
						3		20A (not available for current output type) open collector output
						4		50A (not available for current output type) open collector output
								Not available
							1	Available

CT1 or CT2 for current detection is provided as an accessory when heater burn-out alarm function is added.

### Model No.

(Ex) Model No. when the optional functions (of heating burn-out alarm: 10A) is added on to the basic model is as follows;  
Model No.: AKT7111102

### Options

Product name	Model No.
Shunt resistor (for current input)	AKT4811

Product name	Model No.
Mounting rail	ATA48011

Note: When a current input is specified, a shunt resistor (sold separately) is required.





# KT8

## Wide variety of options, easily readable display



- 1/8 DIN size temperature controller
- Size 48x96x98.5mm (WxHxD)
- Panel-mounted type
- IP66 waterproof (front side if panel mounted)
- 2 set values possible (externally selectable)
- 2nd optional alarm output
- Heating and cooling control with 2nd optional control output (relay, non-contact voltage, or current)

### Product Types

Base model	Power supply	Sensor input	Control output	Alarm output	Heating/cooling control	Heater burnout alarm	Communication function	Description
AKT8								48x96x98.5mm
	1							100 to 240VAC
	2							24VAC/DC
		1						Multi-input (thermocouple, RTD, DC current and DC voltage)
			1					Relay contact output 1a 1b 3A 250VAC
			2					Non-contact voltage output (for SSR drive)
			3					Current output
				1				Relay contact output 1a (alarm output 1)
				2				Relay contact output 1a (alarm output 2)
					0			Not available
					1			Relay contact output 1a
					2			Non-contact voltage output (for SSR drive)
					3			Current output
						0		Not available
						1		5A (heater burn-out alarm not supported when control output is current output type/not supported when heating and cooling control is selected)
						2		10A (heater burn-out alarm not supported when control output is current output type/not supported when heating and cooling control is selected)
						3		20A (heater burn-out alarm not supported when control output is current output type/not supported when heating and cooling control is selected)
						4		50A (heater burn-out alarm not supported when control output is current output type/not supported when heating and cooling control is selected)
								Not available
							1	Available

1) CT1 or CT2 for current detection is provided as an accessory when heater burn-out alarm function is added.

2) If a communication function is added, second main setup is not possible.

### Model No.

(Ex) Model No. when the optional functions (of alarm output; alarm output 2 + heating/cooling control: current output) are added on to the basic model is as follows; Model No.: AKT8111230

### Options

Product name	Model No.
Shunt resistor (for current input)	AKT4810
Terminal cover	AKT8801

Product name	Model No.
Mounting frame	AKW8822

Note: When a current input is specified, a shunt resistor (sold separately) is required.



# KT9

## Big and easily readable display



- 1/4 DIN size temperature controller
- Size 96x96x98.5mm (WxHxD)
- Panel-mounted type
- IP66 waterproof (front side if panel mounted)
- 2 set values possible (externally selectable)
- 2nd optional alarm output
- Heating and cooling control with 2nd optional control output (relay, non-contact voltage, or current)

### Product Types

Base model	Power supply	Sensor input	Control output	Alarm output	Heating/cooling control	Heater burn out alarm	Communication function	Description
AKT9								96x96x98.5mm
	1							100 to 240VAC
	2							24VAC/DC
		1						Multi-input (thermocouple, RTD, DC current and DC voltage)
			1					Relay contact output 1a 1b 3A 250VAC
			2					Non-contact voltage output (for SSR drive)
			3					Current output
				1				Relay contact output 1a (alarm output 1)
				2				Relay contact output 1a (alarm output 2)
					0			Not available
					1			Relay contact output 1a
					2			Non-contact voltage output (for SSR drive)
					3			Current output
						0		Not available
						1		5A (heater burn-out alarm not supported when control output is current output type/not supported when heating and cooling control is selected)
						2		10A (heater burn-out alarm not supported when control output is current output type/not supported when heating and cooling control is selected)
						3		20A (heater burn-out alarm not supported when control output is current output type/not supported when heating and cooling control is selected)
						4		50A (heater burn-out alarm not supported when control output is current output type/not supported when heating and cooling control is selected)
								Not available
							1	Available

- 1.) CT1 or CT2 for current detection is provided as an accessory when heater burn-out alarm function is added.  
 2.) If a communication function is added, second main setup is not possible.

### Model No.

(Ex) Model No. when the optional functions (of alarm output; alarm output 2 + heating/cooling control: non-contact voltage output) are added on to the basic model is as follows; Model No.: AKT9111220

### Options

Product name	Model No.
Shunt resistor (for current input)	AKT4810
Terminal cover	AKT9801

Note: When a current input is specified, a shunt resistor (sold separately) is required.

# Specifications

Model		KT2	KT4	KT4H / KT4B	KT8	KT9	KT7	
Power consumption		Approx. 5VA	Approx. 8VA				Approx. 6VA	
Frequency		50/60Hz						
Alarm output 1 (EVT1) Relay contact Contact material: Ag alloy		Relay contact 1a 3A 250VAC (resistive load) 1a 1A 250VAC (inductive load) cos $\phi$ =0.4)	Relay contact 1a 3A 250VAC (resistive load) Electric life: 100,000 times				Open collector, control capacity: 24VDC 0.1A (max.)	
Alarm output 2 (EVT2)		Open collector 0.1A 24VDC	The same as the one of Alarm output 1				None	
Accuracy	Thermocouple	Within $\pm 0.2\%$ $\pm 1$ digit of each input span or within $\pm 2^\circ\text{C}$ whichever is greater. However, R and S input; within $\pm 6^\circ\text{C}$ in the range of 0 to $200^\circ\text{C}$ B input 0 to $300^\circ\text{C}$ : Accuracy is not guaranteed. K, J, T, E and N input less than $0^\circ\text{C}$ : Within $\pm 0.4\%$ $\pm 1$ digit of input span						
	RTD	Within $\pm 0.1\%$ of each input span $\pm 1$ digit or $\pm 1^\circ\text{C}$ whichever is greater						
	DC current/DC voltage	Within $\pm 0.2\%$ of each input span $\pm 1$ digit						
Sampling period		250ms						
Hysteresis (ON/OFF)		Thermocouple & RTD: 0.1 to $100.0^\circ\text{C}$ DC current and DC voltage: 1 to 1000 (the decimal point place follows the selection)						
Proportional band		For sensor input range and DC current, DC voltage 0.0 to 110.0%	Thermocouple: 0 to $1000^\circ\text{C}$ RTD: 0.0 to $999.9^\circ\text{C}$ / Decimal point input KT4H/KT4B: 0.0 to $1000^\circ\text{C}$ DC current and DC voltage: 0.0 to 100.0%				For sensor input range and DC current, DC voltage 0.0 to 110.0%	
Integral time		0 to 1000 seconds						
Derivative time		0 to 300 seconds						
Proportional cycle		1 to 120 seconds						
Allowable voltage fluctuation		When 100 to 240VAC; 85 to 264VAC, when 24VAC/DC; 20 to 28VAC/DC						
Insulated resistance		500VDC 10M $\Omega$ or greater						
Breakdown voltage		1.5kVAC for 1min between input terminal and power terminal, output terminal and power terminal	1.5kVAC for 1min between input terminal and ground terminal, input terminal and power terminal, power terminal and ground terminal, output terminal and ground terminal, output terminal and power terminal				1.5kVAC for 1min between input terminal and power terminal, output terminal and power terminal	
Malfunction vibration		10 to 55Hz (0.35mm) in each direction (120ms sweep) for 10min.	10 to 55Hz (1 cycle/min.), single amplitude 0.35mm (10 min. on 3 axes)		10 to 55Hz (0.35mm) in each direction (120ms sweep) for 10min.			
Breakdown vibration		10 to 55Hz (0.75mm) in each direction (120ms sweep) for 10min.	10 to 55Hz (1 cycle/min.), single amplitude 0.75mm (1 hour on 3 axes)		10 to 55Hz (0.75mm) in each direction (120ms sweep) for 10min.			
Malfunction shock		X, Y & Z each direction for 5 times 98m/s <sup>2</sup> (10G)						
Breakdown shock		Same as above, but 294m/s <sup>2</sup> (30G)						
Ambient temperature		0 to $50^\circ\text{C}$						
Ambient humidity		35 to 85% RH (no condensation)						
Mass		Approx. 120g	Approx. 130g	Approx. 120g	Approx. 240g	Approx. 370g	Approx. 150g	
Display character height		PV: 8.7mm SV: 8.7mm*	PV: 10.2mm SV: 8.8mm	PV: 12mm SV: 6mm	PV: 11.2mm SV: 11.2mm	PV: 18mm SV: 13.2mm	PV: 7.4mm SV: 7.4mm	
Options	Alarm output 2	0.1A 24VDC	The same as the one of alarm output 1				None	
	Heating/Cooling control	Relay contact: 1a 3A 250VDC (resistive load)	Non-contact relay 0.3A 250VAC (resistive load)	<ul style="list-style-type: none"> <li>Relay contact 1a: 3A 250VAC (resistive load) Electric life: 100,000 time</li> <li>Non contact voltage: 12VDC <math>\pm 15\%</math> max. 40mA (short circuit protected)</li> </ul>		<ul style="list-style-type: none"> <li>Relay contact: 1a 250VAC 3A (resistive load),</li> <li>DC current: 4 to 20mA DC Load resistance: Max. 550 (short-circuit protected)</li> <li>Non-contact voltage: 12 – 14VDC max. 40mA Electric life: 100,000 times 250VAC 1A (inductive load cos<math>\phi</math>=0.4),</li> </ul>		None
	Heater burn-out alarm	Setting accuracy: Within 5% of heater rated current						
	Output	None	Relay contact 1a 250VAC 3A (resistive load), Electric life: 100,000 times				Open collector, Control capacity: 24VDC 0.1A (Max.)	
	Tool port	None		Communication interface C-MOS level, cannot be used at the same time as serial communication (option). This port can only be used with the tool cable (AKT4H820).		None		

\*PV/SV switching display



## KT2 Series

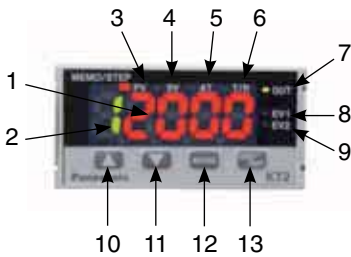

- |    |                            |  |
|----|----------------------------|--|
| 1  | PV/SV display (red):       | Indicates the input value and setting value. During setting mode, characters and setting value of the setting item are indicated in turn.  |
| 2  | MEMO/STEP display (green): | Indicates memory number during fixed value control. Indicates step number during program control.  |
| 3  | PV indicator (red):        | Lights up when the input value (PV) is indicated.  |
| 4  | SV indicator (green):      | Lights up when the main setting value (SV) is indicated.   |
| 5  | AT indicator (yellow):     | Flashes during AT (auto-tuning).   |
| 6  | T/R indicator (yellow):    | Flashes during serial communication (lit while sending data, unlit while receiving data).  |
| 7  | OUT indicator (green):     | Lights up when control output or OUT1 (heating side, option heating/cooling control) is ON: For DC current output type, it flashes corresponding to the manipulated variable in a 0.25 second cycle. |
| 8  | EV1 indicator (red):       | Lights up when event output 1 or OUT2 (cooling side, option heating/cooling control) is ON.  |
| 9  | EV2 indicator (red):       | Lights up when event output 2 is ON.   |
| 10 | Increase key (▲):          | Increases the numeric value.   |
| 11 | Decrease key (▼):          | Decreases the numeric value.   |
| 12 | Mode key (MODE):           | Selects the setting mode or registers the setting value.<br>(By pressing the Mode key, the setting value or selected value can be registered.)   |
| 13 | OUT/OFF key (OFF):         | The control output OUT/OFF or program control RUN/STOP can be switched.  |

## KT4 Series

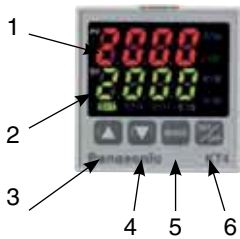

## KT8 Series

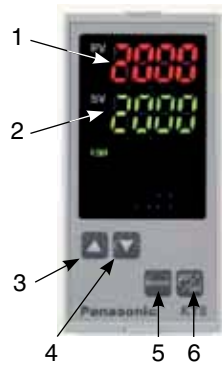

## KT9 Series

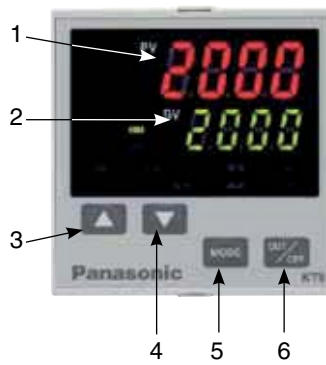

## KT7 Series

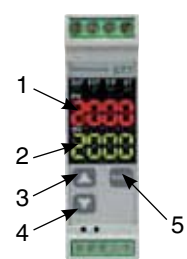

- |   |               |   |
|---|---------------|---|
| 1 | PV display:   | Indicates PV (process variable)                               |
| 2 | SV display:   | Indicates SV (setting value)                                  |
| 3 | Increase key: | Increases numerical value                                     |
| 4 | Decrease key: | Decreases numerical value                                     |
| 5 | Mode key:     | Switches the setting mode                                     |
| 6 | OUT/OFF key:  | Control output is turned on or off when control output is ON. |

Note: Color selection is the same for each size.

## KT4H/4B Series

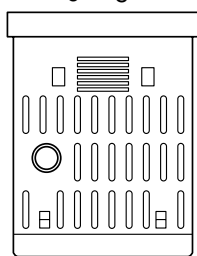
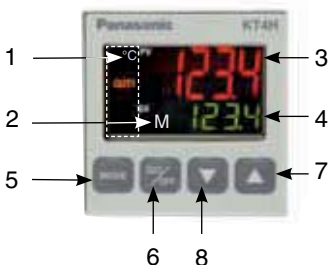

(Bottom side)

- |   |                                       |   |   |
|---|---------------------------------------|---|---|
| 1 | Action indicators (backlight: orange) | *F°C<br>T/R<br>AT<br>OUT1<br>OUT2<br>EVT1<br>EVT2<br>LOCK | Lights respectively when temperature unit *F°C is selected<br>Lights during serial communication (option) TX output.<br>Flashes during auto-tuning or auto-reset<br>Lights when control output is ON or Heating output (option) is ON. For DC current output type, it flashes corresponding to the manipulated variable in 0.25 second cycles<br>Lights when cooling output (option) is ON.<br>Lights when alarm 1 output is ON.<br>Lights when alarm 2 output (option) is ON or heater burn-out alarm (option) is ON.<br>Lights when lock 1, Lock 2 or lock 3 is selected. |
| 2 | MEMO display                          |   | Indicates the set value memory number (backlight: green).   |
| 3 | PV display                            |   | Indicates the PV (process variable) (backlight: red/orange/green).  |
| 4 | SV display                            |   | Indicates the SV (set value) (backlight: green).  |
| 5 | Mode key                              |   | Selects the setting mode and registers the set value.   |
| 6 | OUT/OFF key                           |   | The control output ON/OFF or auto/manual control can be switched.   |
| 7 | Increase key                          |   | Increases the numeric value.  |
| 8 | Decrease key                          |   | Decreases the numeric value.  |
| 9 | Tool connector                        |   | By connecting the tool cable, the following operations can be conducted from the external computer using the exclusive tool software.<br>• Reading and setting of SV, PID and various set values from external computer<br>• Reading of PV and action status<br>• Function change   |

# Communication KT series

## Communication via RS485 and Modbus (ASCII) or Modbus RTU protocol

### Example 1

Multidrop communication with a programmable logical controller (PLC)

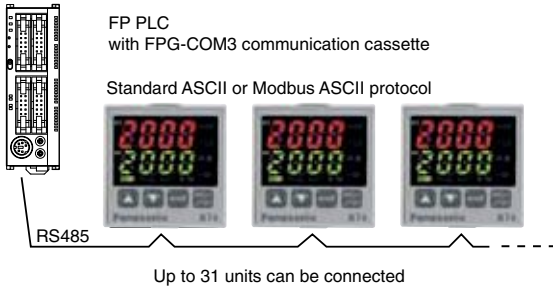

### Example 2

Multidrop communication with a personal computer

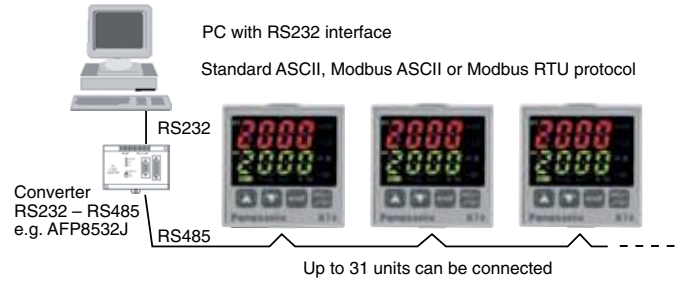

With the optional communication function all settings can be entered or changed. Input value (PV) and other parameters can be read easily. All commands are described in the KT instruction manual.

## Communication via MEWTOCOL (slave) with any FP series PLC\*

Item	Specification
Communication type	Half-duplex
Communication speed	Select 2400, 4800, 9600 or 19200 bps using key operation
Synchronization type	Asynchronous
Protocols	Standard protocol (ASCII), Modbus (ASCII) or Modbus RTU mode (8-bit binary coding), KT4H also MEWTOCOL (Slave)
Coding	ASCII/binary
Error correction	Command re-send
Error detection	Parity check, CRC-16 (RTU), LRC (ASCII)
Data structure	Start bits: 1 Data bit: 7 (ACII), 8 (RTU) Parity: Even, No, Odd (Selectable), KT2: Even (ASCII), None (RTU) Stop bit: 1/2
Interface	RS485 compliant
No. of nodes	31
Maximum cable length	1,000m (cable resistance must be within 50Ω)

Note: Main setting no.2 is not possible on the KT8 and KT9 when the communication functions are added.

# Communication and software KT4H / KT4B

## Connect several KT4H to FP series PLCs

MEWTOCOL communications protocol is built in. Up to 31 units can be connected and data can be collected using a FPΣ (Sigma) PLC.

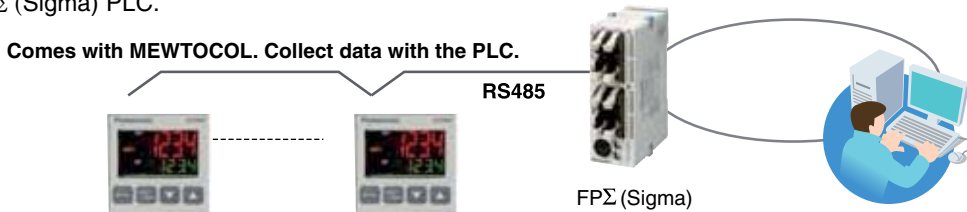

## Standard external tool port

With the external tool port, all settings can be loaded and made.

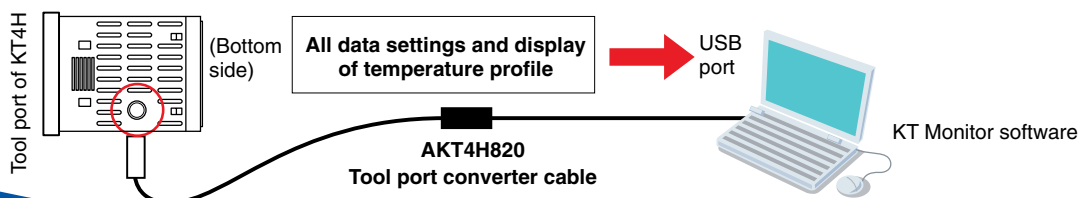

KT Monitor is a convenient software tool for editing the parameters of KT4H, saving parameters in a file, monitoring of temperature data, and monitoring and saving log files of designated values. Parameters can easily be understood and are accessible in a clear, convenient form.

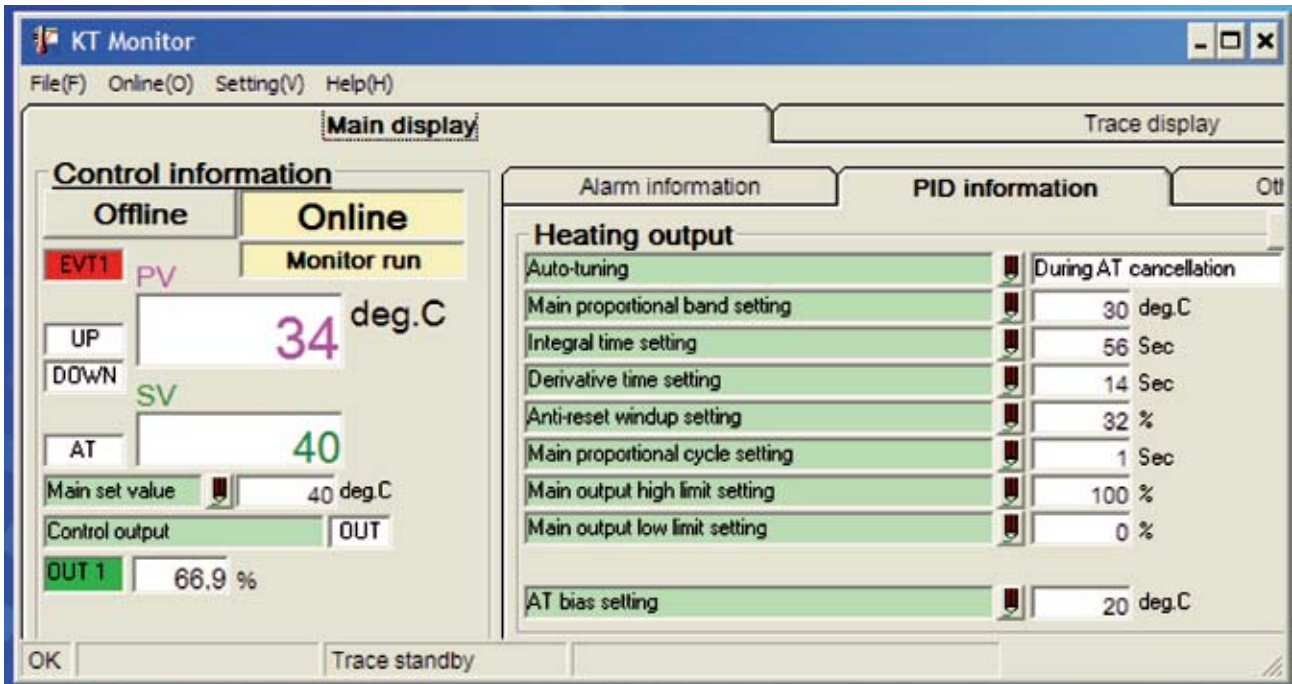

With the Trace display you can display and analyze the temperature PV, the set value SV and the control the output MV. MV2 will be indicated only when heating/cooling control option is added. All values can also be recorded in a CSV-file for further processing with e.g. Excel®.

The colors of the traces are user-definable, the same goes for the interval for recording data (min. 1 second). The total number of records can be set in a range from 600 (10 min.) to 9,000 (15 min.). To scale the values displayed, you can enter upper and lower limits.

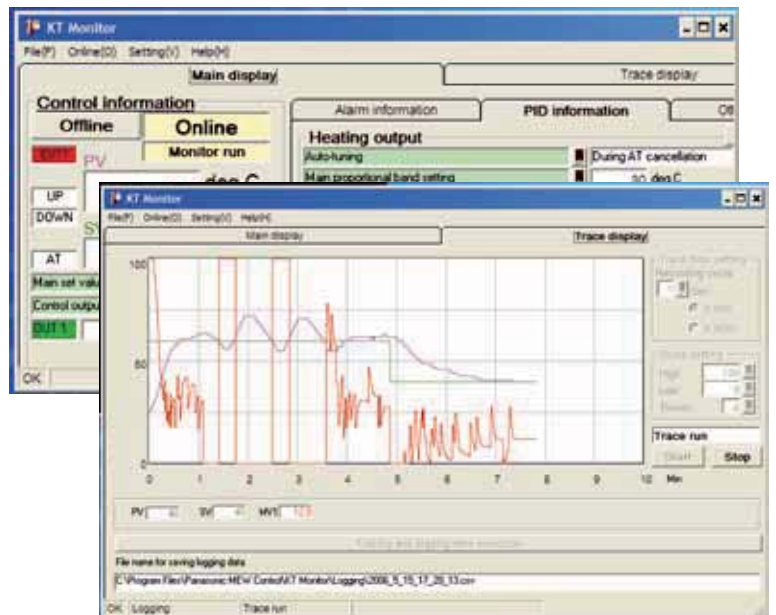

Ordering information: KT Monitor set CD with software, manuals, tool port cable AKT4H820

Requirements: PC with Windows 98/ME/2000 or XP, USB port, tool cable AKT4H820, USB driver installed (included with KT Monitor)



# Dimensions

## KT2 series (unit: mm)

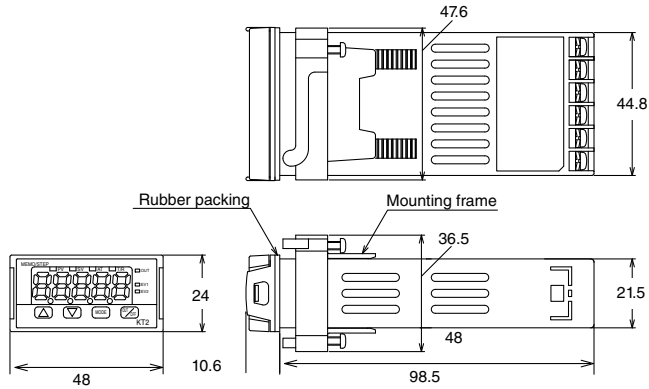

## Panel cutout

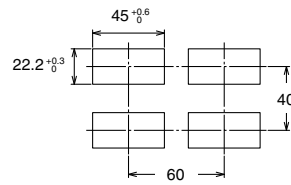

## KT4 series (unit: mm)

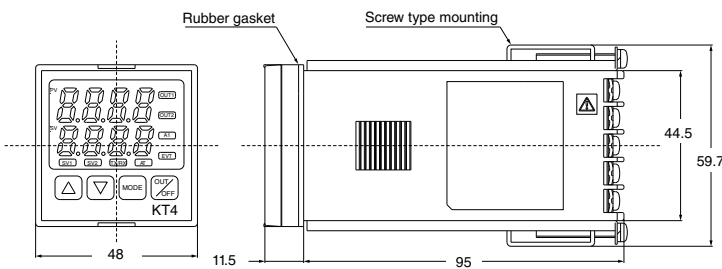

## Panel cutout

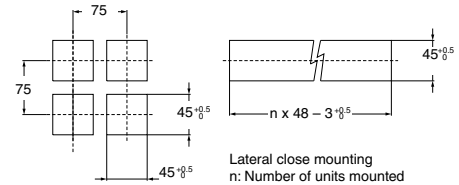

Note: The communications terminal is the screw terminal on the back of the unit.

## KT4H / KT4B series (unit: mm)

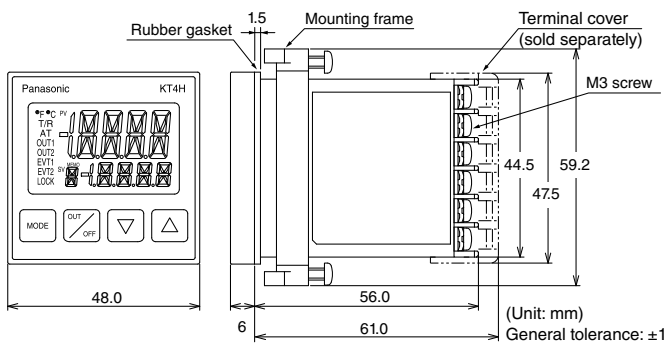

## Panel cutout

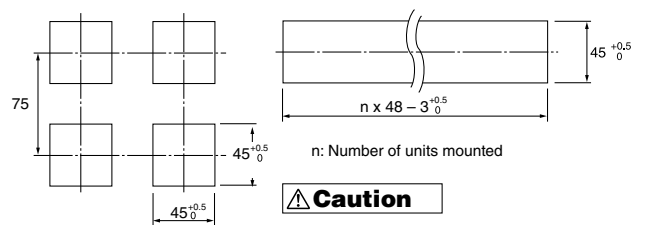

### Caution

If lateral close mounting is used for the controller, IP66 specification (Dust-proof/Drip-Proof) may be compromised, and all warranties will be invalidated.

**KT8 series (unit: mm)**

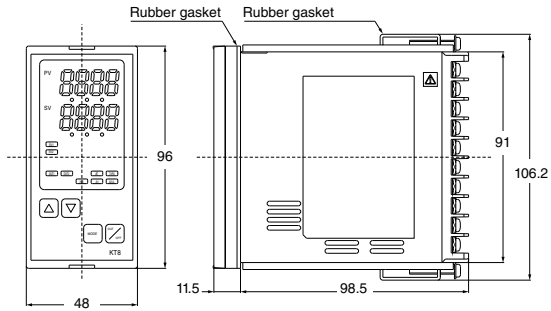

**Panel cutout**

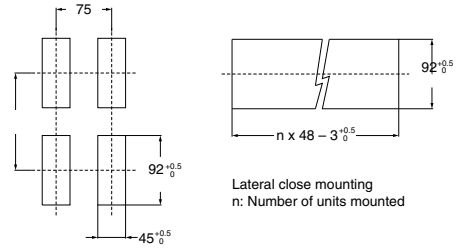

Note: The communications terminal is the screw terminal on the back of the unit.

**KT9 series (unit: mm)**

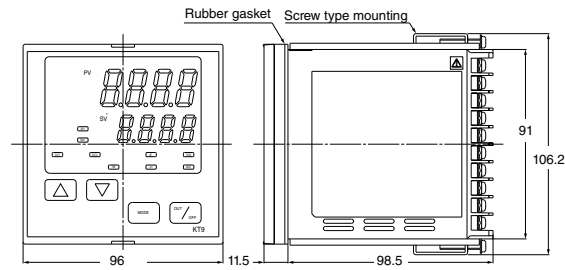

**Panel cutout**

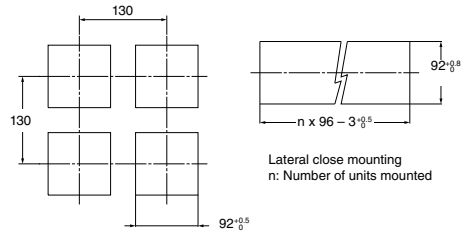

Note: The communications terminal is the screw terminal on the back of the unit.

**KT7 series (unit: mm)**

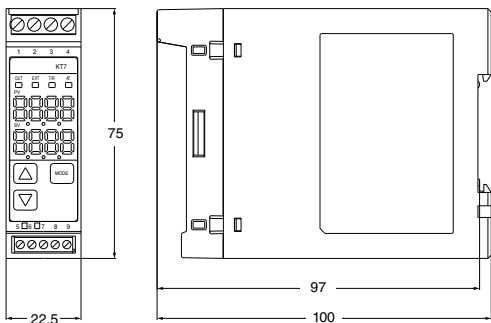

Note: The communications terminal is the modular jack on the bottom of the unit.

**DIN rail mounting**

Recommended DIN rail: Part No. AT8DLA1  
Recommended fastening plate: Part No. ATA4806

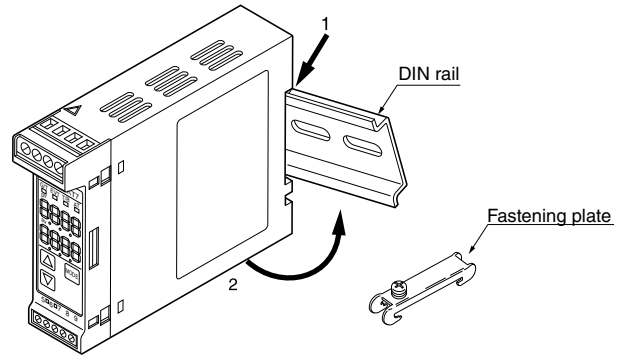

Note: The communications terminal is the modular jack on the bottom of the unit.



**Shunt resistor for current input (mA)**  
**AKT4810** for KT2, KT4, KT4H, KT8, KT9

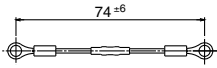

**AKT4811** for KT7

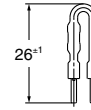

All units on this page are in mm

**Terminal cover to protect rear side screw terminals from contact**  
**AKT4801** for KT4

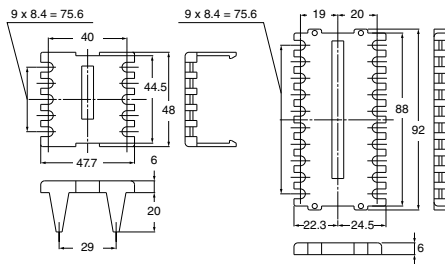

**AKT4H801** for KT4H

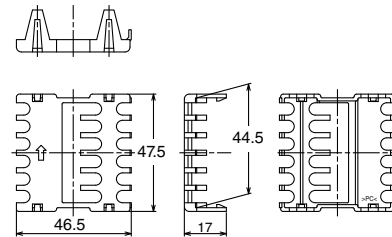

**AKT2801** for KT2

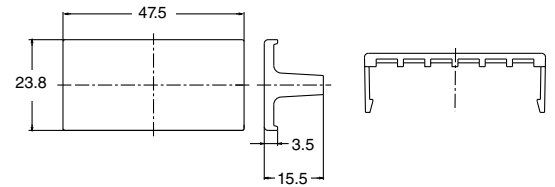

## Current transformer

CT1 or CT2 for current detection is provided as an accessory for all types with the heat burnout alarm function. They are enclosed for these types and need not be ordered separately.

**CT1 (for 20A)**

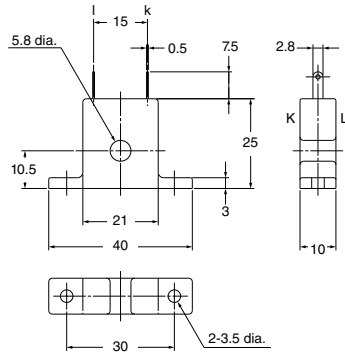

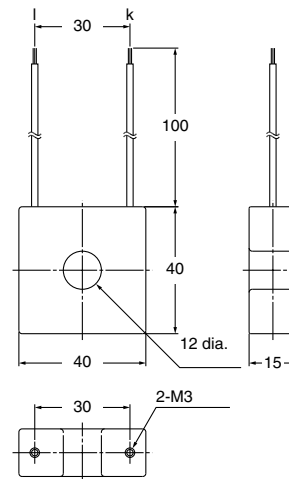

**CT2 (for 50A)**

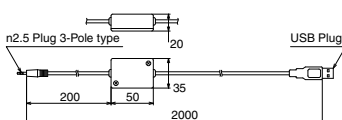

**Tool cable to connect the KT4H's tool port to a PC's USB port.**  
**AKT4H820**



Item	AQG		AQJ			AQN				
										
Dimensions ( W x H x D)	24.5 x 4.5 x 13.5mm		38 x 28 x 17mm			58 x 45 x 22mm				
Contact type	1-Form A		1-Form A			1-Form A				
Load current	1A	2A	10A	15A	25A	10A	15A	20A	25A	40A
Load voltage	75 to 250VAC		75 to 250VAC			75 to 250VAC				
Input voltage	5/12/24VDC		5/12/24VDC			4 to 32VDC				
Function type	Non zero cross		Zero cross			Non zero cross				
Connection type	PCB		Plug-in			Screw connection				
Order no. Non zero cross	AQG22212		-			AQN611				
Order no. Zero cross	AQG22112		AQJ416V			AQN611				

Heat sink		
Item	AQP	
		
Dimensions ( W x H x D)	78 x 28 x 78mm (AQJ)	78 x 45 x 78mm (AQN)
Mounting	DIN rail	
Order No.	AQP-HS-SJ10A	AQP-HS-SJ20A

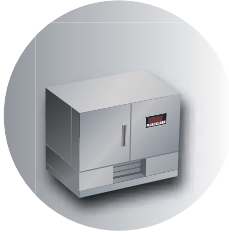

Constant temperature bath

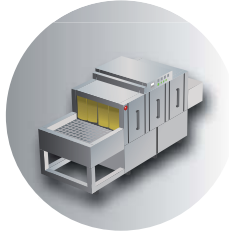

Scrubber

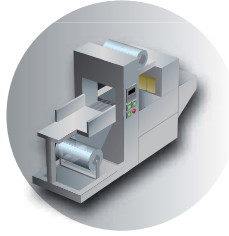

Shrink wrapping machine



Oven



Warm and cold storage units

## Contributing to space savings of various heater control systems

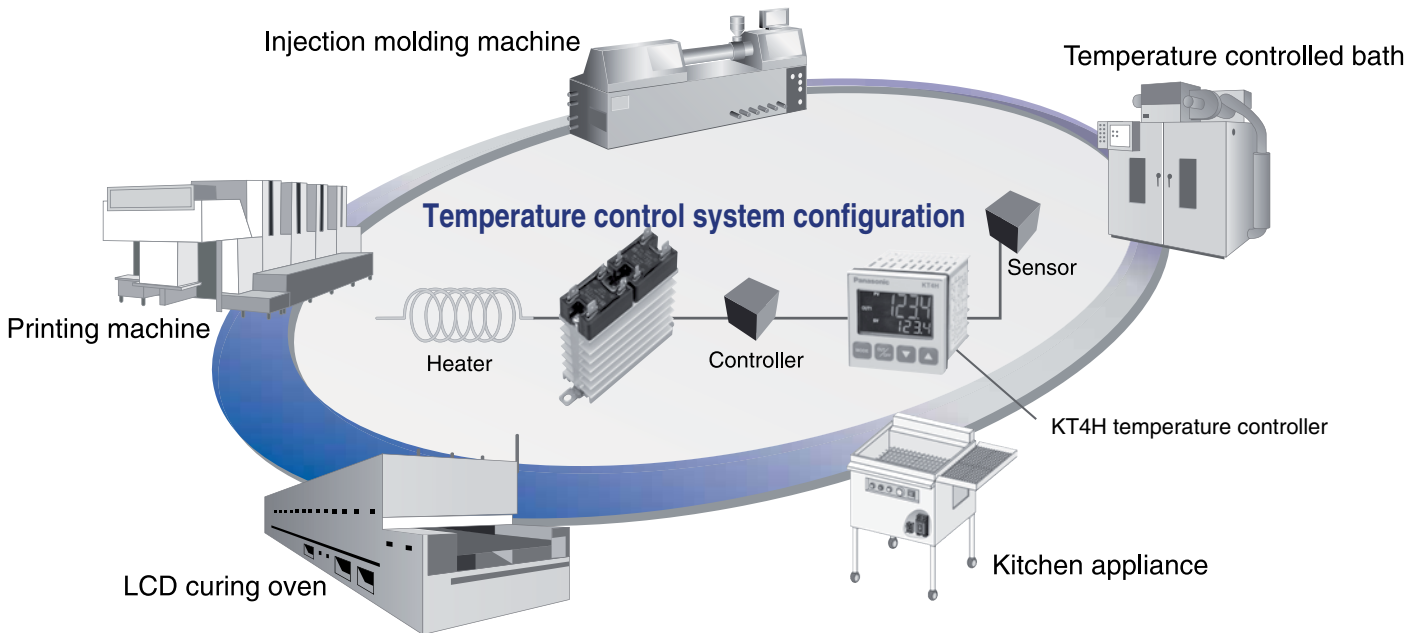



## Eco Power Meters

Panasonic Eco components help you to save energy and protect the environment, maintain and manage your energy-saving and environmental measures. Guards against wasted electricity.



## Timers and counters

Panasonic's precision timers, counters, preset type counters and time switches are flexible, reliable and affordable. Moreover, you can be sure that the wide product range will always include the right device for your application.

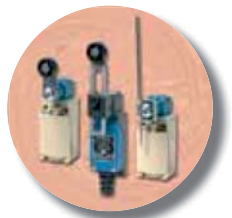

## Limit switches

Panasonic limit switches are compact and highly functional. They have superior contact reliability and weld resistance as well as a long life thanks to our unique contacts and switching mechanisms.

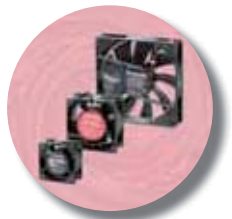

## Fans

For years Panasonic fan motors have been characterized by high performance, a long lifetime and quiet operation. Because of their high performance and availability in all standard sizes and all voltages, our motor fans can be implemented in a wide range of applications.



## Wireless units

With the Panasonic KR20 wireless unit, process data transmission has hit the fast track, transmission security is tighter than ever, and cable clutter and installation marathons have become a thing of the past.

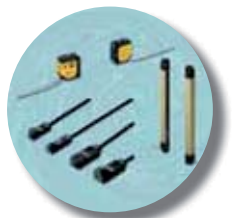

## Sensors

As a pioneering manufacturer of sensors, Panasonic provides high performance sensors for a wide range of applications, facilitating factory automation in various types of production lines, such as those used for the manufacturing of semiconductors.



## UV curing systems

Panasonic's award winning UV curing system, Aicure UJ30/35, is an LED-technology-based curing system that quickly hardens UV-sensitive resin such as adhesives, ink, and coatings. It is especially suited for precise and high-intensity curing of punctiform or small areas.

North America

Europe

Asia Pacific

China

Japan

## Panasonic Electric Works

Please contact our Global Sales Companies in:

### Europe

▶ <b>Headquarters</b>	<b>Panasonic Electric Works Europe AG</b>	Rudolf-Diesel-Ring 2, 83607 Holzkirchen, Tel. +49 (0) 8024 648-0, Fax +49 (0) 8024 648-111, <a href="http://www.panasonic-electric-works.com">www.panasonic-electric-works.com</a>
▶ <b>Austria</b>	<b>Panasonic Electric Works Austria GmbH</b>	Josef Madersperger Str. 2, 2362 Biedermansdorf, Tel. +43 (0) 2236-26846, Fax +43 (0) 2236-46133 <a href="http://www.panasonic-electric-works.at">www.panasonic-electric-works.at</a>
	<b>Panasonic Industrial Devices Materials Europe GmbH</b>	Ennsfenstraße 30, 4470 Enns, Tel. +43 (0) 7223 883, Fax +43 (0) 7223 88333, <a href="http://www.panasonic-electronic-materials.com">www.panasonic-electronic-materials.com</a>
▶ <b>Benelux</b>	<b>Panasonic Electric Works Sales Western Europe B.V.</b>	De Rijn 4, (Postbus 211), 5684 PJ Best, (5680 AE Best), Netherlands, Tel. +31 (0) 499 372727, Fax +31 (0) 499 372185, <a href="http://www.panasonic-electric-works.nl">www.panasonic-electric-works.nl</a>
▶ <b>Czech Republic</b>	<b>Panasonic Electric Works Czech s.r.o.</b>	Sales Office Brno, Administrative centre PLATINIUM, Veveri 111, 616 00 Brno, Tel. +420 541 217 001, Fax +420 541 217 101, <a href="http://www.panasonic-electric-works.cz">www.panasonic-electric-works.cz</a>
▶ <b>France</b>	<b>Panasonic Electric Works Sales Western Europe B.V.</b>	Succursale française, 10, rue des petits ruisseaux, 91370 Verrières Le Buisson, Tél. +33 (0) 1 6013 5757, Fax +33 (0) 1 6013 5758, <a href="http://www.panasonic-electric-works.fr">www.panasonic-electric-works.fr</a>
▶ <b>Germany</b>	<b>Panasonic Electric Works Europe AG</b>	Rudolf-Diesel-Ring 2, 83607 Holzkirchen, Tel. +49 (0) 8024 648-0, Fax +49 (0) 8024 648-111, <a href="http://www.panasonic-electric-works.de">www.panasonic-electric-works.de</a>
▶ <b>Hungary</b>	<b>Panasonic Electric Works Europe AG</b>	Magyarországi Közvetlen Kereskedelmi Képviselet, 1117 Budapest, Neumann János u. 1., Tel. +36 1 999 89 26 <a href="http://www.panasonic-electric-works.hu">www.panasonic-electric-works.hu</a>
▶ <b>Ireland</b>	<b>Panasonic Electric Works UK Ltd.</b>	Irish Branch Office, Dublin, Tel. +353 (0) 14600969, Fax +353 (0) 14601131, <a href="http://www.panasonic-electric-works.co.uk">www.panasonic-electric-works.co.uk</a>
▶ <b>Italy</b>	<b>Panasonic Electric Works Italia srl</b>	Via del Commercio 3-5 (Z.I. Ferlina), 37012 Bussolengo (VR), Tel. +39 0456752711, Fax +39 0456700444, <a href="http://www.panasonic-electric-works.it">www.panasonic-electric-works.it</a>
▶ <b>Nordic Countries</b>	<b>Panasonic Electric Works Europe AG</b> <b>Panasonic Eco Solutions Nordic AB</b>	Filial Nordic, Knarrarnäsgatan 15, 164 40 Kista, Sweden, Tel. +46 859476680, Fax +46 859476690, <a href="http://www.panasonic-electric-works.se">www.panasonic-electric-works.se</a>
▶ <b>Poland</b>	<b>Panasonic Electric Works Polska sp. z o.o.</b>	Jungmangatan 12, 21119 Malmö, Tel. +46 40 697 7000, Fax +46 40 697 7099, <a href="http://www.panasonic-fire-security.com">www.panasonic-fire-security.com</a>
▶ <b>Portugal</b>	<b>Panasonic Electric Works España S.A.</b>	ul. Wofoska 9A, 02-583 Warszawa, Tel. +48 (0) 22 338-11-33, Fax +48 (0) 22 338-12-00, <a href="http://www.panasonic-electric-works.pl">www.panasonic-electric-works.pl</a>
▶ <b>Spain</b>	<b>Panasonic Electric Works España S.A.</b>	Portuguese Branch Office, Avda Adelino Amaro da Costa 728 R/C J, 2750-277 Cascais, Tel. +351 214812520, Fax +351 214812529
▶ <b>Switzerland</b>	<b>Panasonic Electric Works Schweiz AG</b>	Barajas Park, San Severo 20, 28042 Madrid, Tel. +34 913293875, Fax +34 913292976, <a href="http://www.panasonic-electric-works.es">www.panasonic-electric-works.es</a>
▶ <b>United Kingdom</b>	<b>Panasonic Electric Works UK Ltd.</b>	Grundstrasse 8, 6343 Rotkreuz, Tel. +41 (0) 41 7997050, Fax +41 (0) 41 7997055, <a href="http://www.panasonic-electric-works.ch">www.panasonic-electric-works.ch</a>
		Sunrise Parkway, Linford Wood, Milton Keynes, MK14 6 LF, Tel. +44 (0) 1908 231555, Fax +44 (0) 1908 231599, <a href="http://www.panasonic-electric-works.co.uk">www.panasonic-electric-works.co.uk</a>

### North & South America

▶ <b>USA</b>	<b>PEW Corporation of America</b>	629 Central Avenue, New Providence, N.J. 07974, Tel. 1-908-464-3550, Fax 1-908-464-8513, <a href="http://www.pewa.panasonic.com">www.pewa.panasonic.com</a>
--------------	-----------------------------------	---

### Asia Pacific/China/Japan

▶ <b>China</b>	<b>Panasonic Electric Works (China) Co., Ltd.</b>	Level 2, Tower W3, The Towers Oriental Plaza, No. 2, East Chang An Ave., Dong Cheng District, Beijing 100738, Tel. (010) 5925-5988, Fax (010) 5925-5973
▶ <b>Hong Kong</b>	<b>Panasonic Electric Works (Hong Kong) Co., Ltd.</b>	RM1205-9, 12/F, Tower 2, The Gateway, 25 Canton Road, Tsimshatsui, Kowloon, Hong Kong, Tel. (0852) 2956-3118, Fax (0852) 2956-0398
▶ <b>Japan</b>	<b>Panasonic Corporation</b>	1048 Kadoma, Kadoma-shi, Osaka 571-8686, Japan, Tel. (06) 6908-1050, Fax (06) 6908-5781, <a href="http://www.panasonic.net">www.panasonic.net</a>
▶ <b>Singapore</b>	<b>Panasonic Electric Works Asia Pacific Pte. Ltd.</b>	101 Thomson Road, #25-03/05, United Square, Singapore 307591, Tel. (06255) 5473, Fax (06253) 5689