

Thank you for your interest in **onsemi** products.
Your technical document begins on the following pages.



Your Feedback is Important to Us!

Please take a moment to participate in our short survey.
At **onsemi**, we are dedicated to delivering technical content that best meets your needs.

[Help Us Improve – Take the Survey](#)

This survey is intended to collect your feedback, capture any issues you may encounter, and to provide improvements you would like to suggest.

We look forward to your feedback.

To learn more about **onsemi**, please visit our website at
www.onsemi.com

onsemi and **onsemi** and other names, marks, and brands are registered and/or common law trademarks of Semiconductor Components Industries, LLC dba "**onsemi**" or its affiliates and/or subsidiaries in the United States and/or other countries. **onsemi** owns the rights to a number of patents, trademarks, copyrights, trade secrets, and other intellectual property. A listing of **onsemi** product/patent coverage may be accessed at www.onsemi.com/site/pdf/Patent-Marking.pdf. **onsemi** reserves the right to make changes at any time to any products or information herein, without notice. The information herein is provided "as-is" and **onsemi** makes no warranty, representation or guarantee regarding the accuracy of the information, product features, availability, functionality, or suitability of its products for any particular purpose, nor does **onsemi** assume any liability arising out of the application or use of any product or circuit, and specifically disclaims any and all liability, including without limitation special, consequential or incidental damages. Buyer is responsible for its products and applications using **onsemi** products, including compliance with all laws, regulations and safety requirements or standards, regardless of any support or applications information provided by **onsemi**. "Typical" parameters which may be provided in **onsemi** data sheets and/or specifications can and do vary in different applications and actual performance may vary over time. All operating parameters, including "Typicals" must be validated for each customer application by customer's technical experts. **onsemi** does not convey any license under any of its intellectual property rights nor the rights of others. **onsemi** products are not designed, intended, or authorized for use as a critical component in life support systems or any FDA Class 3 medical devices or medical devices with a same or similar classification in a foreign jurisdiction or any devices intended for implantation in the human body. Should Buyer purchase or use **onsemi** products for any such unintended or unauthorized application, Buyer shall indemnify and hold **onsemi** and its officers, employees, subsidiaries, affiliates, and distributors harmless against all claims, costs, damages, and expenses, and reasonable attorney fees arising out of, directly or indirectly, any claim of personal injury or death associated with such unintended or unauthorized use, even if such claim alleges that **onsemi** was negligent regarding the design or manufacture of the part. **onsemi** is an Equal Opportunity/Affirmative Action Employer. This literature is subject to all applicable copyright laws and is not for resale in any manner. Other names and brands may be claimed as the property of others.

Intelligent Power Module (IPM)

Inverter, 1200 V, 30 A

NFA33012L72

General Description

NFA33012L72 is an advanced IPM module providing a fully-featured, high-performance inverter output stage for AC Induction, BLDC and PMSM motors. These modules integrate optimized gate drive of the built-in IGBTs to minimize EMI and losses, while also providing multiple on-module protection features including under-voltage lockouts, over-current shutdown, thermal monitoring of drive IC, and fault reporting. The built-in, high-speed HVIC requires only a single supply voltage and translates the incoming logic-level gate inputs to the high-voltage, high-current drive signals required to properly drive the module's internal IGBTs. Separate negative IGBT terminals are available for each phase to support the widest variety of control algorithms.

Features

- 1200 V/30 A 3-phase FS7 IGBT Inverter with Integral Gate Drivers and Protections
- Built-in Under-Voltage Protection (UVP)
- Separated Open-Emitter Pins from Low-Side IGBTs for Three-Phase Current Sensing
- LVIC Temperature-Sensing Built-In for Temperature Monitoring
- Isolation Rating: 2500 Vrms / 1 min.
- This Device is Pb-Free and is RoHS Compliant

Typical Applications

- Industrial Drives
- Industrial Pumps
- Industrial Fans
- Industrial Automation

Integrated Power Functions

- 1200 V – 30 A IGBT inverter for three-phase DC / AC power conversion (Please refer to Figure 1)

Integrated Drive, Protection and System Control Functions

- For Inverter High-side IGBTs: gate drive circuit, high-voltage isolated high-speed level shifting control circuit Under-Voltage Lock-Out Protection (UVLO)
- For Inverter Low-side IGBTs: gate drive circuit, Over Current Protection (OCP) control supply circuit Under-Voltage Lock-Out Protection (UVLO)
- Fault Signaling: corresponding to UVLO (low-side supply) and over current fault
- Input Interface: active-HIGH interface, works with 3.3 / 5 V logic, Schmitt-trigger input

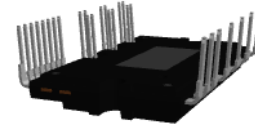

3D Package Drawing
(Click to Active 3D Content)

SPMCA-027 / PDD STD, SPM27-CA, DBC TYPE
CASE MODFJ

MARKING DIAGRAM

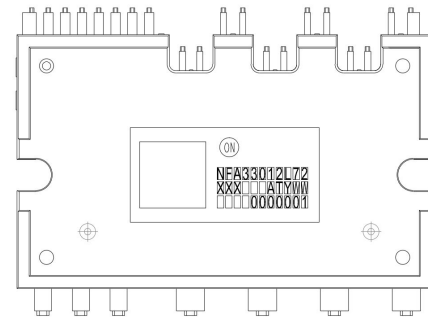

NFA33012L72 = Specific Device Code
XXX = Last 3 Digits of Lot No
AT = Assembly & Test Site
YWW = Year and Work Week Code
0000001 = Serial Number

ORDERING INFORMATION

Device	Package	Shipping
NFA33012L72	SPM27-CA	10 Units / Tube

NFA33012L72

PACKAGE MARKING AND ORDERING INFORMATION

Device	Device Marking	Package	Packing Type	Quantity
NFA33012L72	NFA33012L72	SPM27-SC	Tube	10

PIN CONFIGURATION

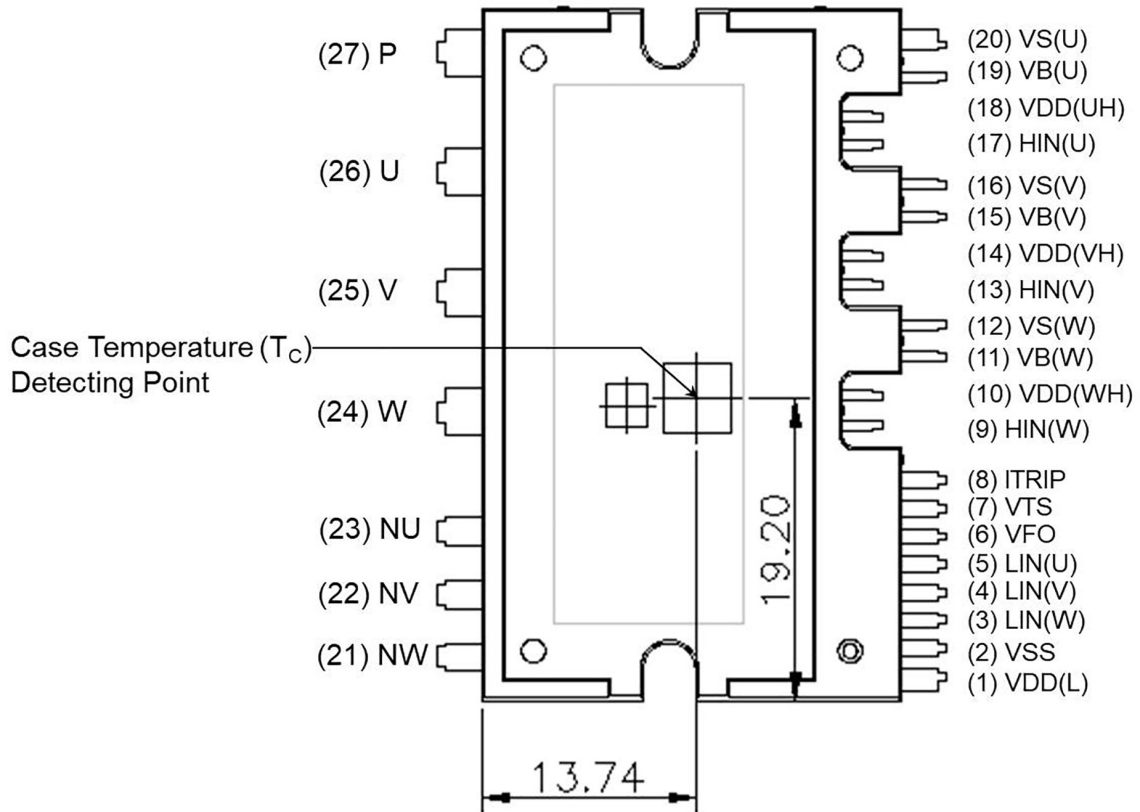

Figure 1. Pin Configuration

NFA33012L72

PIN DESCRIPTION

Pin No.	Symbol	Description
1	VDD(L)	Low-Side Bias Voltage for IC and IGBTs Driving
2	VSS	Low-Side Common Supply Ground
3	LIN(W)	Signal Input for Low-Side W-Phase
4	LIN(V)	Signal Input for Low-Side V-Phase
5	LIN(U)	Signal Input for Low-Side U-Phase
6	VFO	Fault Output
7	VTSS	Output for LVIC Temperature Sensing Voltage Output
8	ITRIP	Input for Over Current Protection
9	HIN(W)	Signal Input for High-Side W-Phase
10	VDD(WH)	High-Side Bias Voltage for W-Phase IC
11	VB(W)	High-Side Bias Voltage for W-Phase IGBT Driving
12	VS(W)	High-Side Bias Voltage Ground for W-Phase IGBT Driving
13	HIN(V)	Signal Input for High-Side V-Phase
14	VDD(VH)	High-Side Bias Voltage for V-Phase IC
15	VB(V)	High-Side Bias Voltage for V-Phase IGBT Driving
16	VS(V)	High-Side Bias Voltage Ground for V-Phase IGBT Driving
17	HIN(U)	Signal Input for High-Side U-Phase
18	VDD(UH)	High-Side Bias Voltage for U-Phase IC
19	VB(U)	High-Side Bias Voltage for U-Phase IGBT Driving
20	VS(U)	High-Side Bias Voltage Ground for U-Phase IGBT Driving
21	NW	Negative DC-Link Input for W-Phase
22	NV	Negative DC-Link Input for V-Phase
23	NU	Negative DC-Link Input for U-Phase
24	W	Output for W-Phase
25	V	Output for V-Phase
26	U	Output for U-Phase
27	P	Positive DC-Link Input

NFA33012L72

INTERNAL EQUIVALENT CIRCUIT AND INPUT/OUTPUT PINS

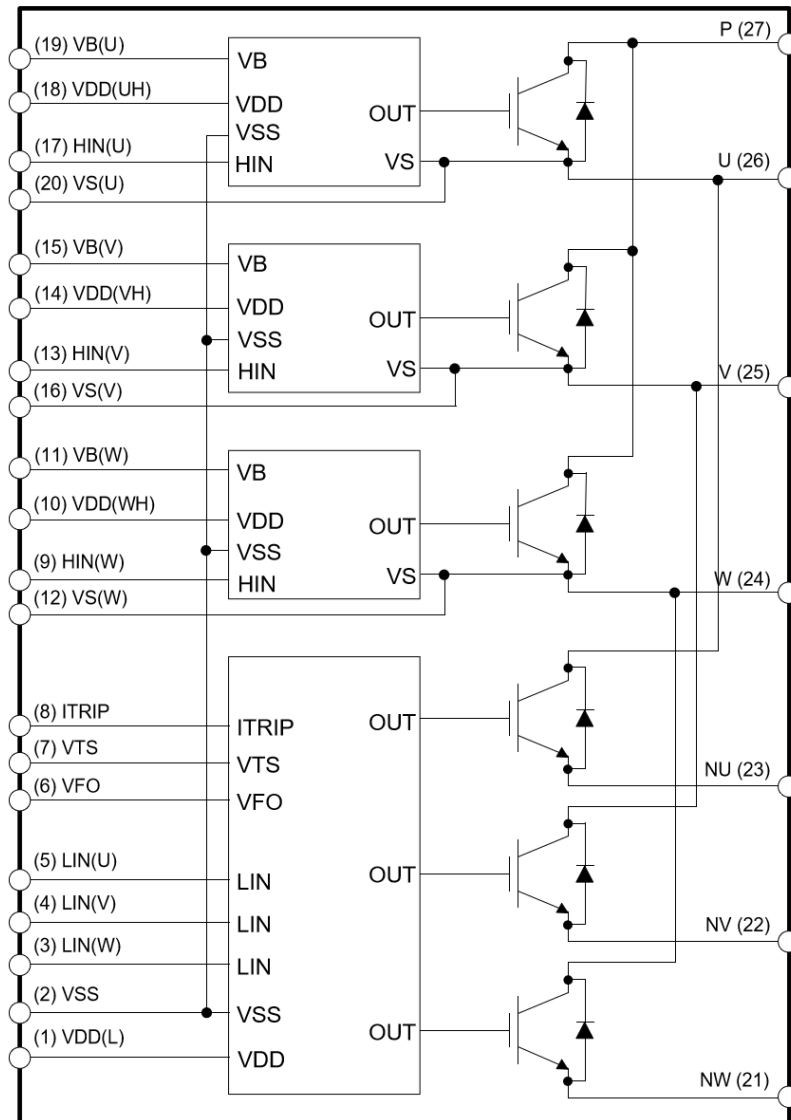

Figure 2. Internal Block Diagram

NOTES:

1. Inverter low-side is composed of three IGBTs, freewheeling diodes for each IGBT, and one control IC. It has gate drive and protection functions.
2. Inverter power side is composed of four inverter DC-link input terminals and three inverter output terminals.
3. Inverter high-side is composed of three IGBTs, freewheeling diodes, and three drive ICs for each IGBT.

NFA33012L72

ABSOLUTE MAXIMUM RATINGS (T_j = 25°C unless otherwise specified)

Symbol	Parameter	Test Condition	Rating	Unit
INVERTER PART				
VPN	Supply Voltage	Applied between P – NU, NV, NW	900	V
VPN (surge)	Supply Voltage (Surge)	Applied between P – NU, NV, NW	1000	V
Vces	Collector–Emitter Voltage	(Note 4)	1200	V
±Ic	Each IGBT Collector Current	T _c = 25°C, T _j ≤ 150°C (Note 5)	30	A
±Icp	Each IGBT Collector Current (Peak)	T _c = 25°C, T _j ≤ 150°C, under 1ms Pulse Width (Note 5)	60	A
Pc	Collector Dissipation	T _c = 25°C per One Chip (Note 5)	357	W
T _j	Operating Junction Temperature		–40 ~ 150	°C

CONTROL PART

VDD	Control Supply Voltage	Applied between VDD(H), VDD(L) – VSS	20	V
VBS	High–Side Control Bias Voltage	Applied between VB(U) – VS(U), VB(V) – VS(V), VB(W) – VS(W)	20	V
VIN	Input Signal Voltage	Applied between HIN(U), HIN(V), HIN(W), LIN(U), LIN(V), LIN(W) – VSS	–0.3 ~ VDD + 0.3	V
VFO	Fault Output Supply Voltage	Applied between VFO – VSS	–0.3 ~ VDD + 0.3	V
IFO	Fault Output Current	Sink Current at VFO pin	2	mA
VITRIP	Current Sensing Input Voltage	Applied between ITRIP – VSS	–0.3 ~ VDD + 0.3	V

TOTAL SYSTEM

VPN (PROT)	Self–Protection Supply Voltage Limit (Over Current Protection Capability)	VDD = VBS = 13.5 ~ 16.5 V, T _j = 150°C, Non–repetitive, < 2 μs	800	V
T _c	Case Operation Temperature	See Figure 1	–40 ~ 125	°C
T _{stg}	Storage Temperature		–40 ~ 125	°C
Viso	Isolation Voltage	60 Hz, Sinusoidal, AC 1 minute, Connection Pins to Heat Sink Plate	2500	V _{rms}

Stresses exceeding those listed in the Maximum Ratings table may damage the device. If any of these limits are exceeded, device functionality should not be assumed, damage may occur and reliability may be affected.

4. This is not for continuous DC voltage. Recommend to use max 960 V (80% of rated voltage) for continuous DC voltage.

5. These values had been made by the calculation considered to design factor.

THERMAL RESISTANCE

Symbol	Parameter	Test Condition	Min	Typ	Max	Unit
R _{th(j–c)Q}	Junction to Case Thermal Resistance	Inverter IGBT part (per 1/6 module)	–	–	0.35	°C/W
R _{th(j–c)F}		Inverter FWDi part (per 1/6 module)	–	–	0.70	°C/W
L _σ	Package Stray Inductance	P to NU, NV, NW (Note 6)	–	24	–	nH

6. Stray inductance per phase measured per IEC 60747–15.

NFA33012L72

ELECTRICAL CHARACTERISTICS (T_j = 25°C unless otherwise specified)

Symbol	Parameter	Test Condition	Min	Typ	Max	Unit	
INVERTER PART							
VCE(sat)	Collector-Emitter Saturation Voltage	VDD = VBS = 15 V, VIN = 5 V, Ic = 20 A, Tj = 25°C	-	1.5	1.9	V	
		VDD = VBS = 15 V, VIN = 5V, Ic = 20 A, Tj = 150°C	-	1.75	-		
VF	FWDi Forward Voltage	VIN = 0 V, IF = 20 A, Tj = 25°C	-	1.7	2.1	V	
		VIN = 0 V, IF = 20 A, Tj = 150°C	-	1.65	-		
HS	High Side Switching Times	VPN = 600 V, VDD = 15 V, Ic = 20 A, Tj = 25°C VIN = 0 V ↔ 5 V, Inductive Load See Figure 3 (Note 7)	0.90	1.05	1.20	μs	
			ton	-	0.15		0.30
			toff	-	1.15		1.25
			tc(off)	-	0.25		0.35
			trr	-	0.20		-
LS	Low Side Switching Times	VPN = 600 V, VDD = 15 V, Ic = 20 A, Tj = 25°C VIN = 0 V ↔ 5 V, Inductive Load See Figure 3 (Note 7)	0.60	0.75	0.95	μs	
			ton	-	0.18		0.30
			toff	-	1.07		1.17
			tc(off)	-	0.25		0.35
			trr	-	0.20		-
Ices	Collector - Emitter Leakage Current	Tj = 25°C, VCE = VCES	-	-	1	mA	

Product parametric performance is indicated in the Electrical Characteristics for the listed test conditions, unless otherwise noted. Product performance may not be indicated by the Electrical Characteristics if operated under different conditions.

7. tON and tOFF include the propagation delay time of the internal drive IC. tC(ON) and tC(OFF) are the switching time of IGBT itself under the given gate driving condition internally. For the detailed information, please see Figure 3.

SWITCHING TIME DEFINITION

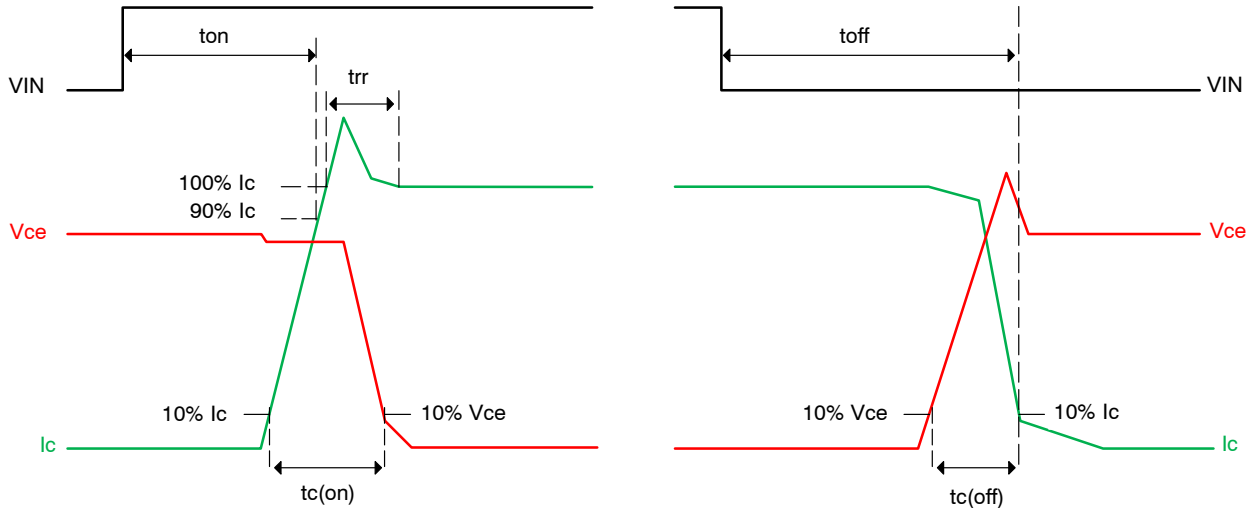

Figure 3. Switching Time Definition

NFA33012L72

ELECTRICAL CHARACTERISTICS (T_J = 25°C unless otherwise specified)

Symbol	Parameter	Test Condition	Min	Typ	Max	Unit	
CONTROL PART							
IQDDH	Quiescent VDD Supply Current	VDD(H) = 15 V, HIN(U,V,W) = 0 V	VDD(H) – VSS	–	–	0.15	mA
IQDDL		VDD(L) = 15 V, LIN(U,V,W) = 0 V	VDD(L) – VSS	–	–	5.00	mA
IPDDH	Operating VDD Supply Current	VDD(H) = 15 V, fPWM = 20 kHz, duty = 50%, applied to one PWM signal input for High-Side	VDD(H) – VSS	–	–	0.30	mA
IPDDL		VDD(L) = 15 V, fPWM = 20 kHz, duty = 50%, applied to one PWM signal input for Low-Side	VDD(L) – VSS	–	–	6	mA
IQBS	Quiescent VBS Supply Current	VBS = 15 V, HIN(U,V,W) = 0 V	VB(U) – VS(U), VB(V) – VS(V), VB(W) – VS(W)	–	–	0.30	mA
IPBS	Operating VBS Supply Current	VDD = VBS = 15 V, fPWM = 20 kHz, duty = 50%, applied to one PWM signal input for High-Side	VB(U) – VS(U), VB(V) – VS(V), VB(W) – VS(W)	–	–	2.50	mA
VFOH	Fault Output Voltage	VDD = 15 V, VITRIP = 0 V, 4.7 kΩ Pull-up to 5 V	4.5	–	–	V	
VFOL		VDD = 15 V, VITRIP = 1 V, 4.7 kΩ Pull-up to 5 V	–	–	0.5	V	
VITRIP	Over Current Trip Level	VDD = 15 V (Note 8)	ITRIP – VSS	0.45	0.50	0.55	V
UVDDD	Supply Circuit Under-Voltage Protection	Detection Level		10.3	–	12.8	V
UVDDR		Reset Level		10.8	–	13.3	V
UVBSD		Detection Level		9.5	–	12.0	V
UVBSR		Reset Level		10.0	–	12.5	V
tFOD	Fault-Out Pulse Width		50	–	–	μs	
VTS	LVIC Temperature Sensing Voltage Output	VDD(L) = 15 V, TLVIC = 25°C (Note 9) <i>See Figure 4</i>	0.88	0.98	1.08	V	
VIN(ON)	ON Threshold Voltage	Applied between HIN(U,V,W) – VSS, LIN(U,V,W) – VSS	–	–	2.6	V	
VIN(OFF)	OFF Threshold Voltage		0.8	–	–	V	

Product parametric performance is indicated in the Electrical Characteristics for the listed test conditions, unless otherwise noted. Product performance may not be indicated by the Electrical Characteristics if operated under different conditions.

8. Over current protection is functioning only at the low-sides.

9. T_{LVIC} is the temperature of LVIC itself. V_{TS} is only for sensing temperature of LVIC and can not shutdown IGBTs automatically.

NFA33012L72

RECOMMENDED OPERATING CONDITIONS

Symbol	Parameter	Test Conditions	Min	Min	Max	Unit
VPN	Supply Voltage	Applied between P – NU, NV, NW	–	600	800	V
VDD	Control Supply Voltage	Applied between VDD(H) – VSS, VDD(L) – VSS	13.5	15.0	16.5	V
VBS	High-Side Bias Voltage	Applied between VB(U) – VS(U), VB(V) – VS(V), VB(W) – VS(W)	13.0	15.0	18.5	V
dVDD / dt, dVBS / dt	Control Supply Variation		–1	–	1	V/ μ s
Tdead	Blanking Time for Preventing Arm – Short	For Each Input Signal	1.5	–	–	μ s
fPWM	PWM Input Signal	$-40^{\circ}\text{C} \leq T_c \leq 125^{\circ}\text{C}$, $-40^{\circ}\text{C} \leq T_j \leq 150^{\circ}\text{C}$	–	–	20	kHz
VSEN	Voltage for Current Sensing	Applied between NU, NV, NW – VSS (Including Surge Voltage)	–5	–	5	V
PWIN(ON)	Minimum Input Pulse Width	VDD = VBS = 15 V, $I_c \leq 50$ A, Wiring Inductance between NU, V, W and DC Link N < 10 nH (Note 10)	1.5	–	–	μ s
PWIN(OFF)			2.0	–	–	μ s
Tj	Junction Temperature		–40	–	150	$^{\circ}\text{C}$

Functional operation above the stresses listed in the Recommended Operating Ranges is not implied. Extended exposure to stresses beyond the Recommended Operating Ranges limits may affect device reliability.

10. This product might not make response if input pulse width is less than the recommended value.

TEMPERATURE PROFILE OF VTS (TYPICAL)

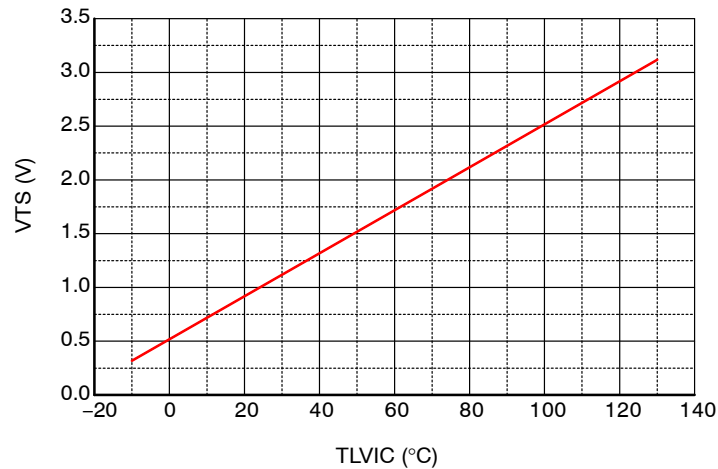

Figure 4. Temperature Profile of VTS (Typical)

MECHANICAL CHARACTERISTICS AND RATINGS

Parameter	Conditions	Limits			Unit	
		Min	Typ	Max		
Device Flatness	See Figure 5	0	-	+150	μm	
Mounting Torque	Mounting Screw: M3 See Figure 6	Recommended 0.7 N • m	0.6	0.7	0.8	N • m
		Recommended 7.1 kg • cm	6.2	7.1	8.1	kg • cm
Terminal Pulling Strength	Load 19.6 N	10	-	-	s	
Terminal Bending Strength	Load 9.8 N, 90 deg. bend	2	-	-	times	
Weight		-	15	-	g	

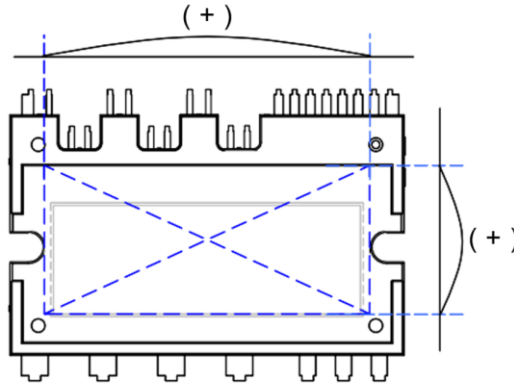

Figure 5. Flatness Measurement Position

MOUNTING SCREW TORQUE ORDER

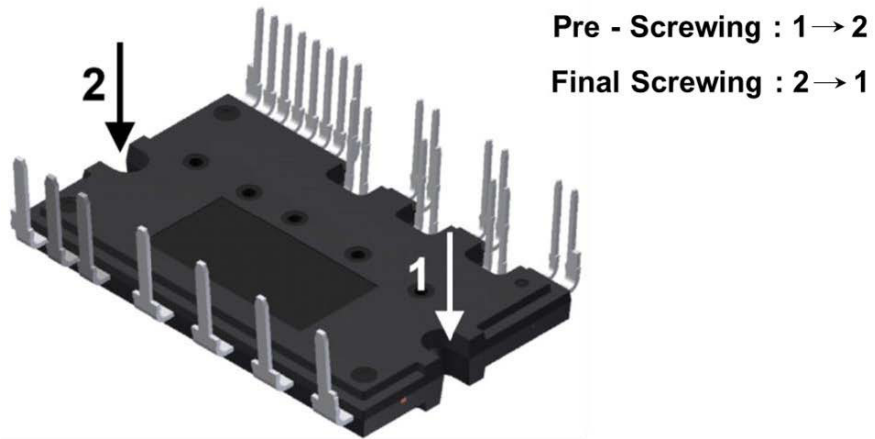

Figure 6. Mounting Screws Torque Order

TIME CHARTS OF PROTECTIVE FUNCTION

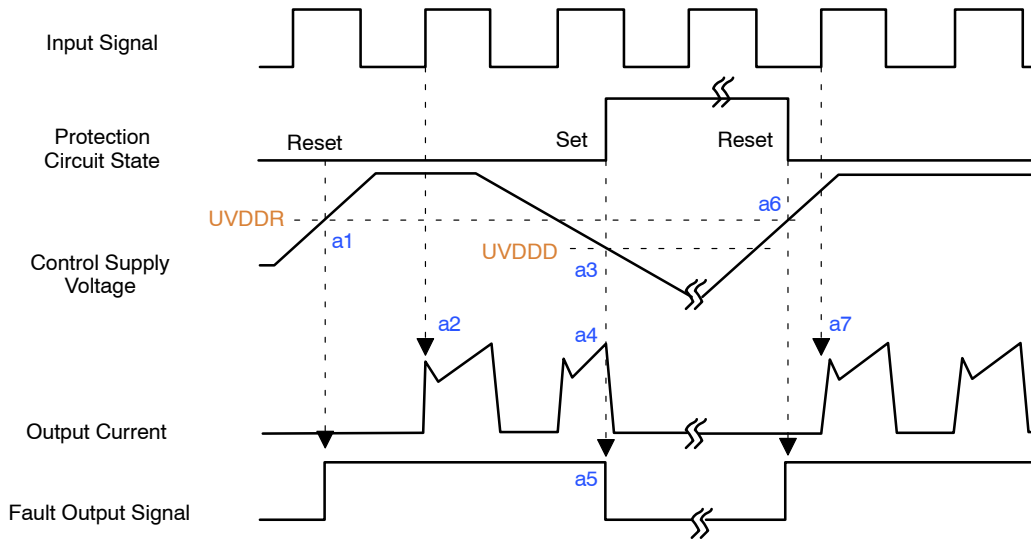

Figure 7. Under-Voltage Protection (Low-Side)

- a1: Control supply voltage rises: After the voltage rises UVDDR, the circuits start to operate when next input is applied.
- a2: Normal operation: IGBT ON and carrying current.
- a3: Under voltage detection (UVDDD).
- a4: IGBT OFF in spite of control input condition.
- a5: Fault output operation starts with a fixed pulse width.
- a6: Under voltage reset (UVDDR).
- a7: Normal operation: IGBT ON and carrying current by triggering next signal from LOW to HIGH.

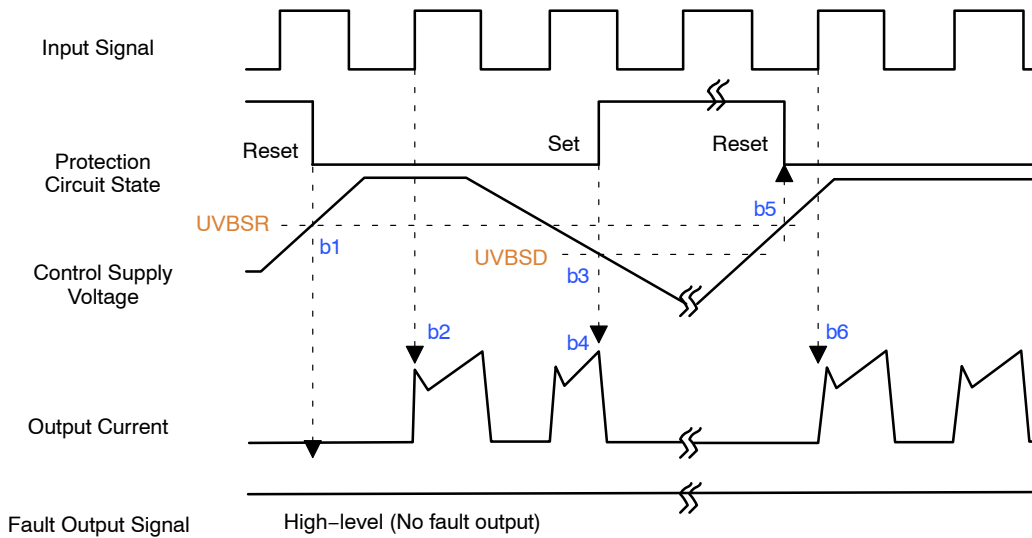

Figure 8. Under-Voltage Protection (High-Side)

- b1: Control supply voltage rises: After the voltage reaches UVBSR, the circuits start to operate when next input is applied.
- b2: Normal operation: IGBT ON and carrying current.
- b3: Under voltage detection (UVBSD).
- b4: IGBT OFF in spite of control input condition, but there is no fault output signal.
- b5: Under voltage reset (UVBSR).
- b6: Normal operation: IGBT ON and carrying current by triggering next signal from LOW to HIGH.

NFA33012L72

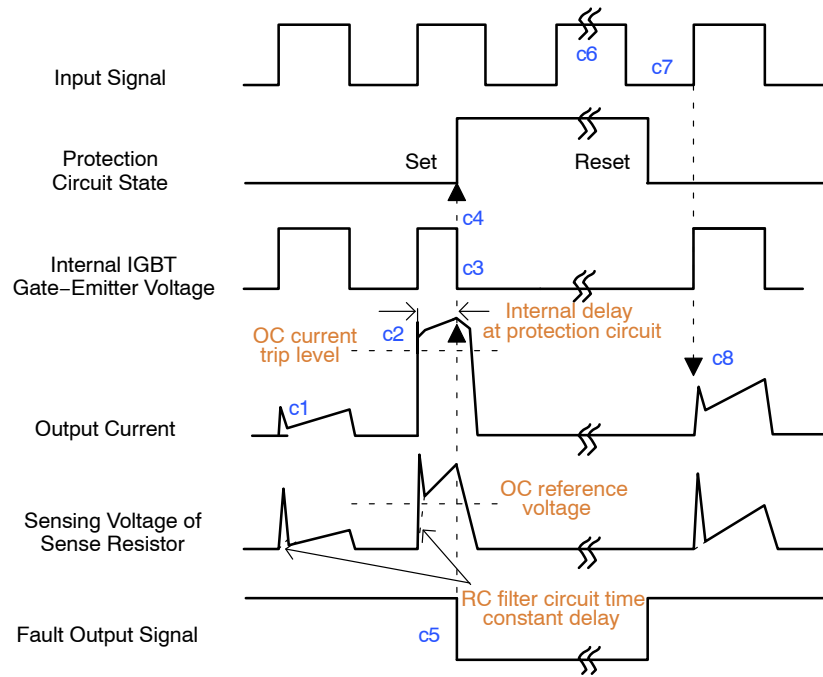

Figure 9. Over Current Protection (Low –Side Operation Only)

(with the external sense resistance and RC filter connection)

c1: Normal operation: IGBT ON and carrying current.

c2: Over current detection (OC trigger).

c3: All low-side IGBT gate are hard interrupted.

c4: All low-side IGBTs turn OFF.

c5: Fault output operation starts with a fixed pulse width.

c6: Input HIGH: IGBT ON state, but during the active period of fault output the IGBT doesn't turn ON.

c7: Fault output operation finishes, but IGBT doesn't turn on until triggering next signal from LOW to HIGH.

c8: Normal operation: IGBT ON and carrying current.

TYPICAL APPLICATION CIRCUIT

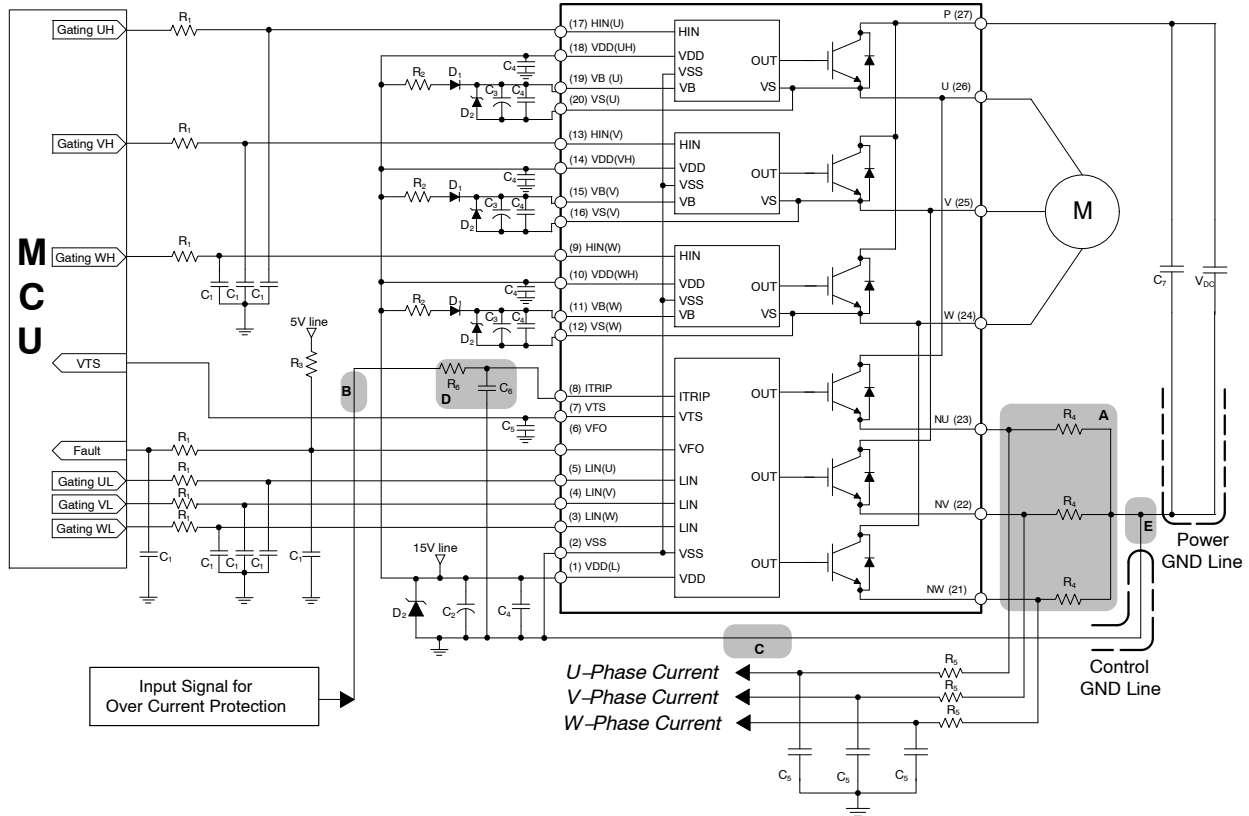

Figure 10. Typical Application Circuit

NOTES:

11. To avoid malfunction, the wiring of each input should be as short as possible. (less than 2 – 3 cm)
12. V_{FO} output is open-drain type. This signal line should be pulled up to the positive side of the MCU or control power supply with a resistor that makes I_{FO} up to 2 mA.
13. Input signal is active-HIGH type. There is a 5 k Ω resistor inside the IC to pull-down each input signal line to GND. RC coupling circuits should be adopted for the prevention of input signal oscillation. R_1C_1 time constant should be selected in the range 50 ~ 150 ns. (Recommended $R_1 = 100 \Omega$, $C_1 = 1 \text{ nF}$)
14. Each wiring pattern inductance of A point should be minimized (Recommend less than 10 nH). Use the shunt resistor R_4 of surface mounted (SMD) type to reduce wiring inductance. To prevent malfunction, wiring of point E should be connected to the terminal of the shunt resistor R_4 as close as possible.
15. To prevent errors of the protection function, the wiring of B, C, and D point should be as short as possible.
16. In the over current protection circuit, please select the R_6C_6 time constant in the range 1.5 ~ 2 μs . Do enough evaluation on the real system because over current protection time may vary wiring pattern layout and value of the R_6C_6 time constant.
17. Each capacitor should be mounted as close to the pins of the product as possible.
18. To prevent surge destruction, the wiring between the snubber capacitor C_7 and the P & GND pins should be as short as possible. The use of a high-frequency non-inductive capacitor of around 0.1 ~ 0.22 μF between the P & GND pins is recommended.
19. Relays are used at almost every systems of electrical equipment at industrial application. In these cases, there should be sufficient distance between the CPU and the relays.
20. The zener diode or transient voltage suppressor should be adopted for the protection of ICs from the surge destruction between each pair of control supply terminals (Recommended zener diode is 22 V / 1 W, which has the lower zener impedance characteristic than about 15 Ω).
21. C_2 of around 7 times larger than bootstrap capacitor C_3 is recommended.
22. Please choose the electrolytic capacitor with good temperature characteristic in C_3 . Also, choose 0.1 ~ 0.2 μF R-category ceramic capacitors with good temperature and frequency characteristics in C_4 .

TYPICAL CHARACTERISTICS

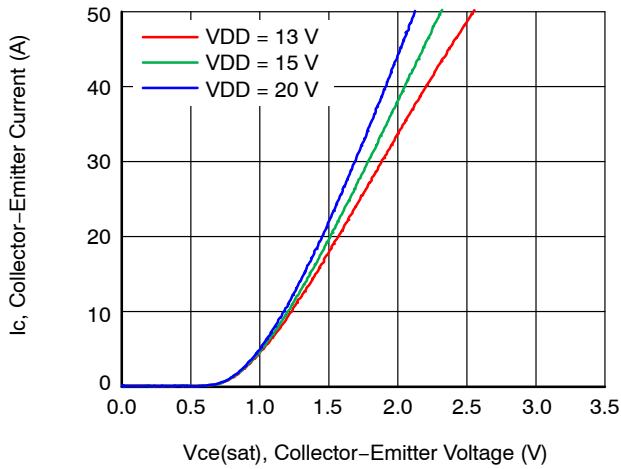

Figure 11. Typ. Collector-Emitter Saturation Voltage

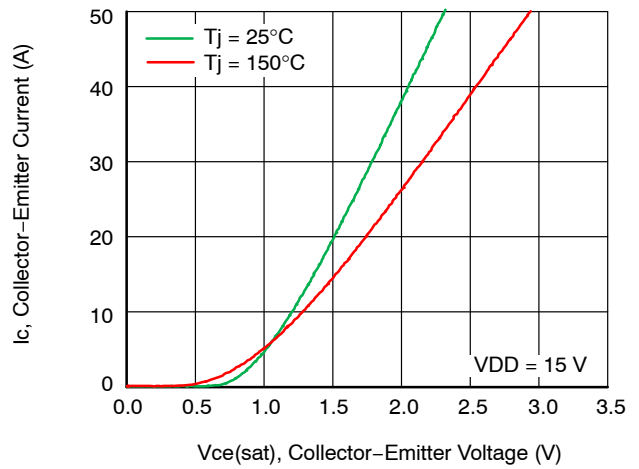

Figure 12. Typ. Collector-Emitter Saturation Voltage

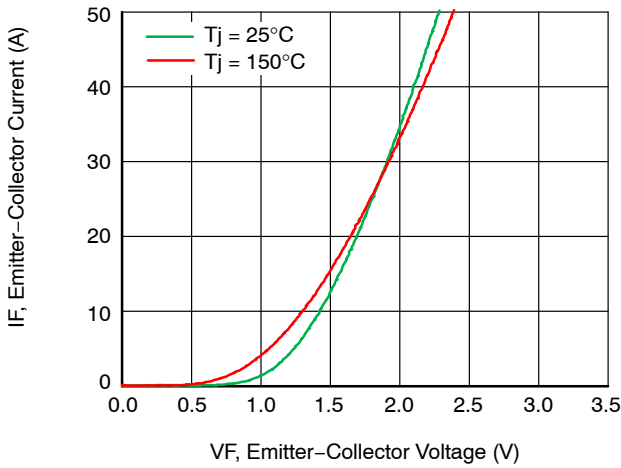

Figure 13. Typ. Emitter-Collector Forward Voltage

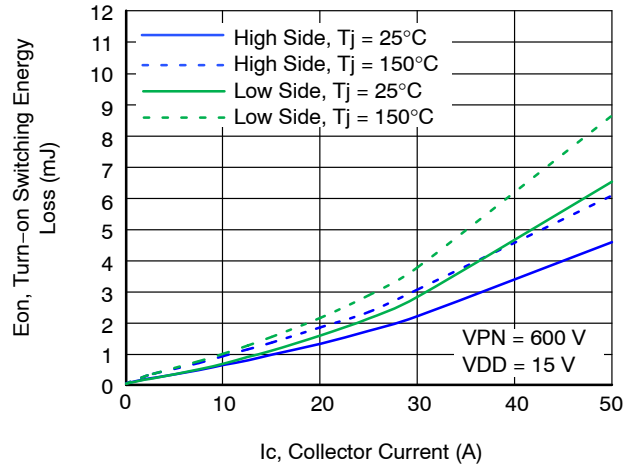

Figure 14. Typ. Turn-on Switching Energy Loss

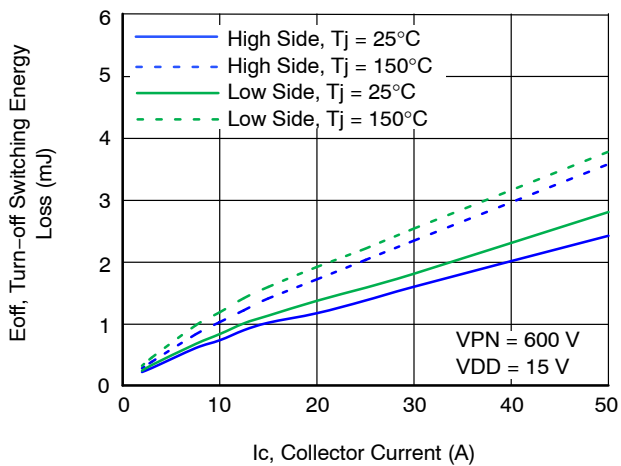

Figure 15. Typ. Turn-off Switching Energy Loss

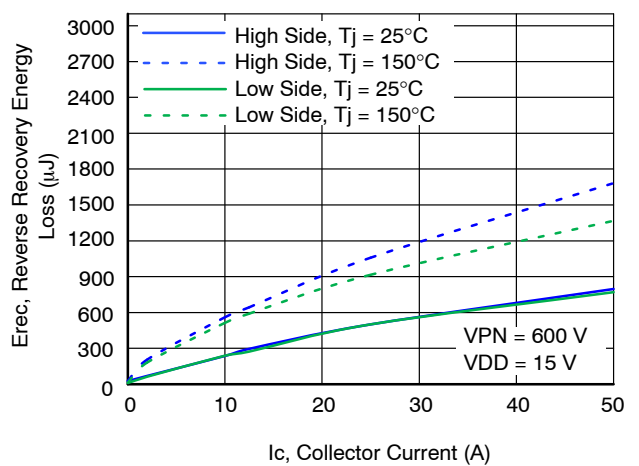

Figure 16. Typ. Reverse Recovery Energy Loss

TYPICAL CHARACTERISTICS

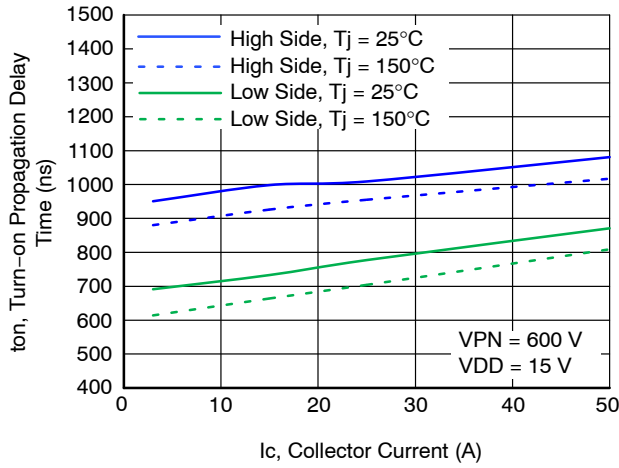

Figure 17. Typ. Turn-on Propagation Delay Time

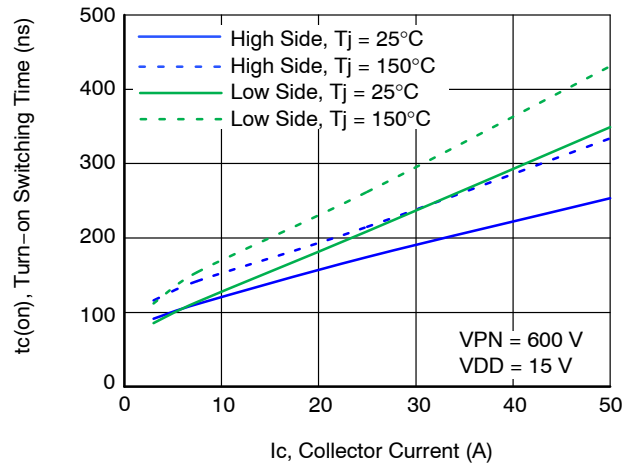

Figure 18. Typ. Turn-on Switching Time

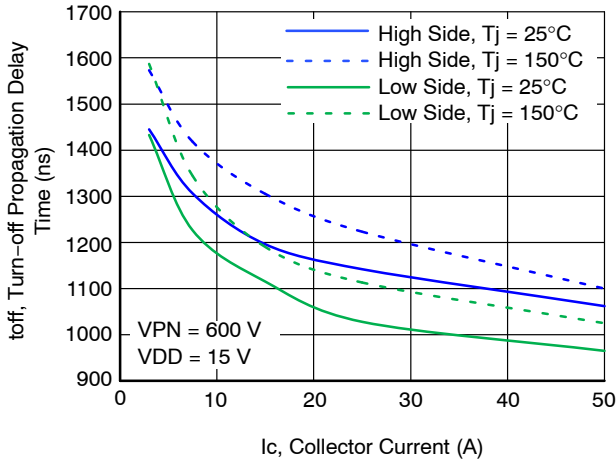

Figure 19. Typ. Turn-off Propagation Delay Time

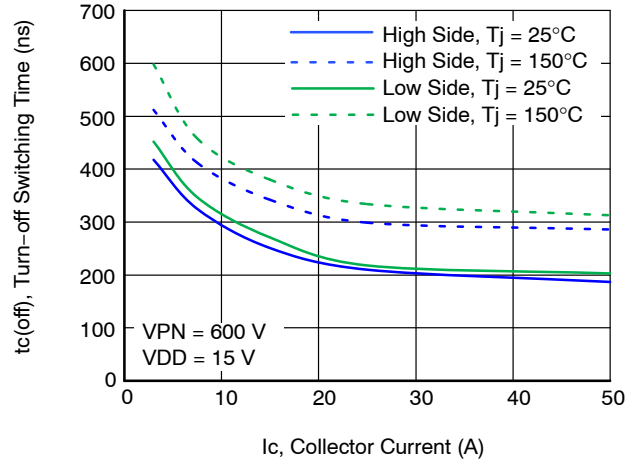

Figure 20. Typ. Turn-off Switching Time

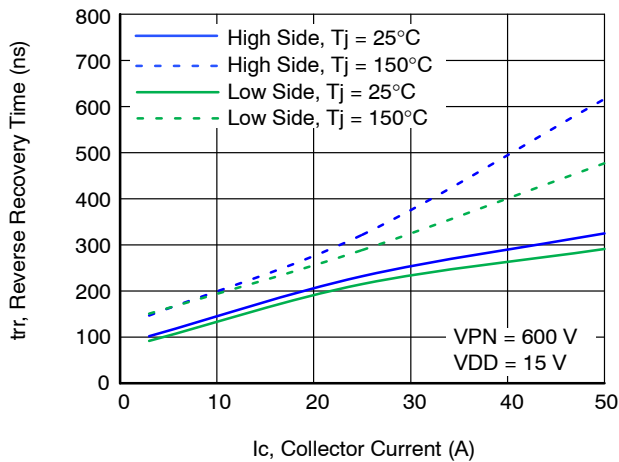

Figure 21. Typ. Reverse Recovery Time

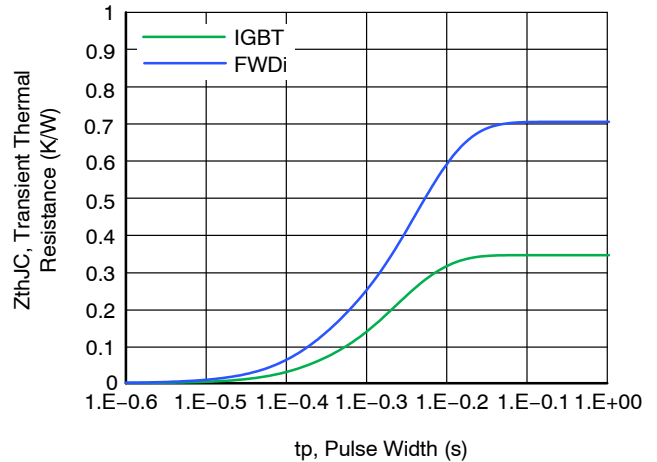

Figure 22. Transient Thermal Resistance

TURN-ON/OFF SWITCHING WAVEFORM

Switching conditions: $V_{DC} = 600\text{ V}$, $V_{DD} = 15\text{ V}$, $T_j = 25^\circ\text{C}$, $I_c = 20\text{ A}$

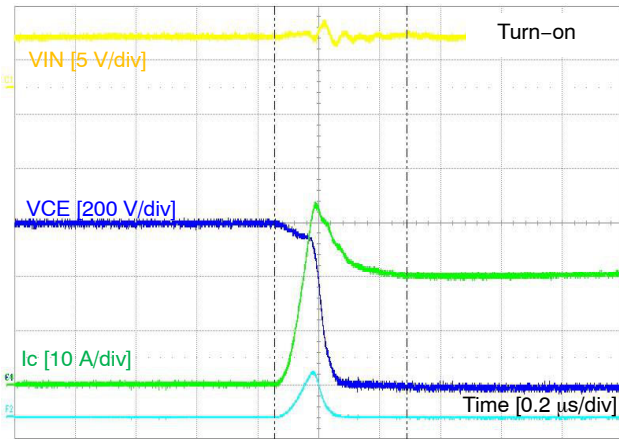

Figure 23. Turn-on Switching Waveform

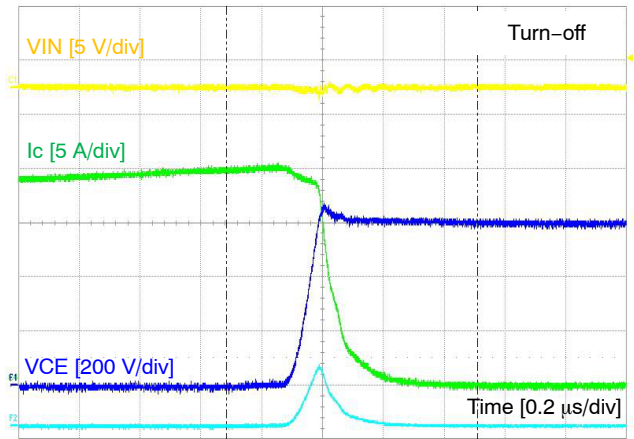

Figure 24. Turn-off Switching Waveform

MECHANICAL CASE OUTLINE PACKAGE DIMENSIONS

ON Semiconductor®



SPMCA-027 / PDD STD, SPM27-CA, DBC TYPE CASE MODFJ ISSUE O

DATE 31 JAN 2017

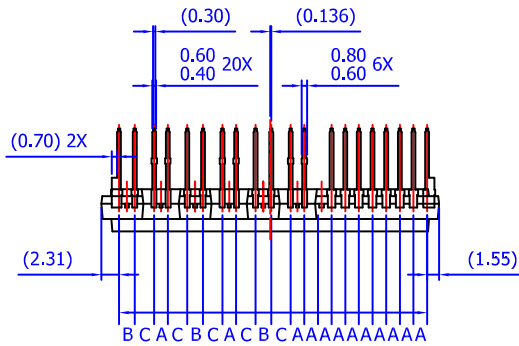

LEAD PITCH (TOLERANCE : ±0.30)

- A : 1.778
- B : 2.050
- C : 2.531

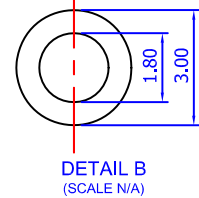
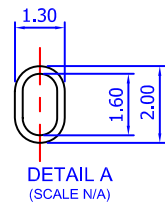
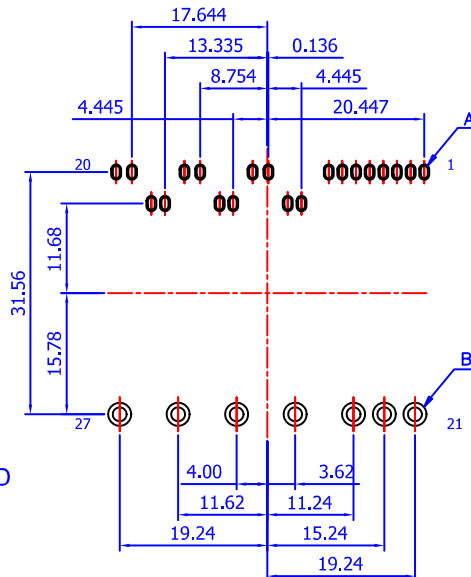
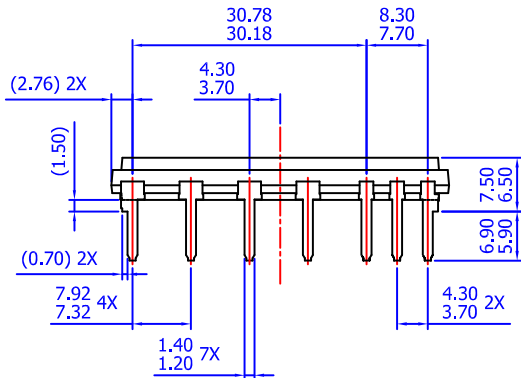
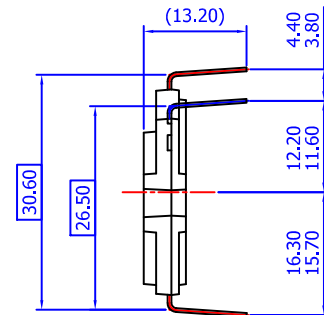
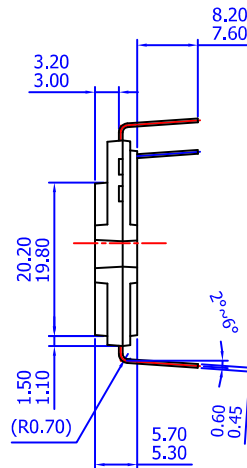
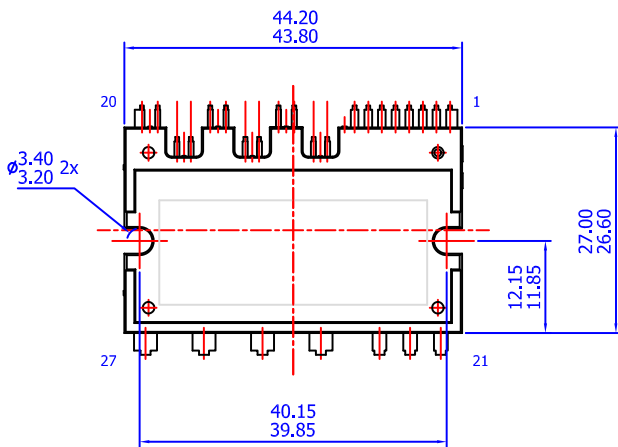

- NOTES: UNLESS OTHERWISE SPECIFIED
- A) THIS PACKAGE DOES NOT COMPLY TO ANY CURRENT PACKAGING STANDARD
 - B) ALL DIMENSIONS ARE IN MILLIMETERS
 - C) DIMENSIONS ARE EXCLUSIVE OF BURRS, MOLD FLASH, AND TIE BAR EXTRUSIONS
 - D) () IS REFERENCE

LAND PATTERN RECOMMENDATIONS

DOCUMENT NUMBER:	98AON13563G	Electronic versions are uncontrolled except when accessed directly from the Document Repository. Printed versions are uncontrolled except when stamped "CONTROLLED COPY" in red.
DESCRIPTION:	SPMCA-027 / PDD STD, SPM27-CA, DBC TYPE	PAGE 1 OF 1

ON Semiconductor and ON are trademarks of Semiconductor Components Industries, LLC dba ON Semiconductor or its subsidiaries in the United States and/or other countries. ON Semiconductor reserves the right to make changes without further notice to any products herein. ON Semiconductor makes no warranty, representation or guarantee regarding the suitability of its products for any particular purpose, nor does ON Semiconductor assume any liability arising out of the application or use of any product or circuit, and specifically disclaims any and all liability, including without limitation special, consequential or incidental damages. ON Semiconductor does not convey any license under its patent rights nor the rights of others.

onsemi, **Onsemi**, and other names, marks, and brands are registered and/or common law trademarks of Semiconductor Components Industries, LLC dba "**onsemi**" or its affiliates and/or subsidiaries in the United States and/or other countries. **onsemi** owns the rights to a number of patents, trademarks, copyrights, trade secrets, and other intellectual property. A listing of **onsemi**'s product/patent coverage may be accessed at www.onsemi.com/site/pdf/Patent-Marking.pdf. **onsemi** reserves the right to make changes at any time to any products or information herein, without notice. The information herein is provided "as-is" and **onsemi** makes no warranty, representation or guarantee regarding the accuracy of the information, product features, availability, functionality, or suitability of its products for any particular purpose, nor does **onsemi** assume any liability arising out of the application or use of any product or circuit, and specifically disclaims any and all liability, including without limitation special, consequential or incidental damages. Buyer is responsible for its products and applications using **onsemi** products, including compliance with all laws, regulations and safety requirements or standards, regardless of any support or applications information provided by **onsemi**. "Typical" parameters which may be provided in **onsemi** data sheets and/or specifications can and do vary in different applications and actual performance may vary over time. All operating parameters, including "Typicals" must be validated for each customer application by customer's technical experts. **onsemi** does not convey any license under any of its intellectual property rights nor the rights of others. **onsemi** products are not designed, intended, or authorized for use as a critical component in life support systems or any FDA Class 3 medical devices or medical devices with a same or similar classification in a foreign jurisdiction or any devices intended for implantation in the human body. Should Buyer purchase or use **onsemi** products for any such unintended or unauthorized application, Buyer shall indemnify and hold **onsemi** and its officers, employees, subsidiaries, affiliates, and distributors harmless against all claims, costs, damages, and expenses, and reasonable attorney fees arising out of, directly or indirectly, any claim of personal injury or death associated with such unintended or unauthorized use, even if such claim alleges that **onsemi** was negligent regarding the design or manufacture of the part. **onsemi** is an Equal Opportunity/Affirmative Action Employer. This literature is subject to all applicable copyright laws and is not for resale in any manner.

ADDITIONAL INFORMATION

TECHNICAL PUBLICATIONS:

Technical Library: www.onsemi.com/design/resources/technical-documentation
onsemi Website: www.onsemi.com

ONLINE SUPPORT: www.onsemi.com/support

For additional information, please contact your local Sales Representative at www.onsemi.com/support/sales