



Electrical Contractor Products

• *Offering Better Alternatives*



1	Push-Wire Connectors for Junction Boxes, Series 773 (Wall-nuts™)	1
2	Compact Connectors, Series 222 (Lever-nuts™)	2
3	Lighting, "Service", and MICRO Connectors, Series 224 & Series 243	3
4	Terminal Blocks for Chassis Mounting, Series 862	4
5	High Current Terminal Blocks, Series 285	5
6	DIN Rail Mount Outlet Boxes, CPO Series	6
7	Pluggable Relay Modules, Surge Protection Devices, Series 788 & WAGO PROTECT Series	7
8	Rail, Tools, & Accessories, Miscellaneous Series	8

Push-Wire Connectors for Junction Boxes, (re-use solid wire), Series 773 (Wall-nuts™)

Fast, Easy, Reliable Connection:

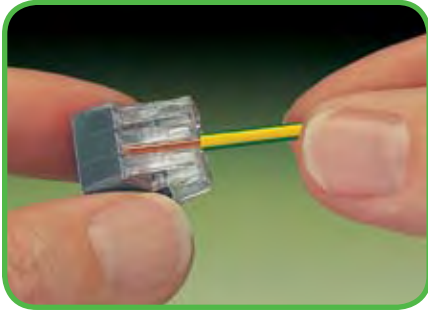

Simply strip conductor to 12 mm /0.47 in. using the built-in strip-length gauge

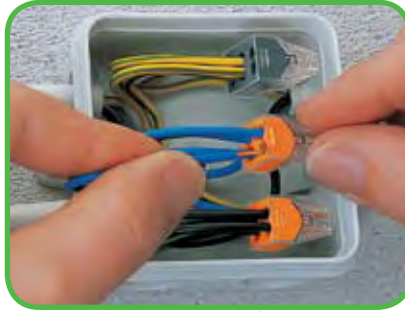

Then insert stripped conductor firmly into connector. Check for complete insertion.

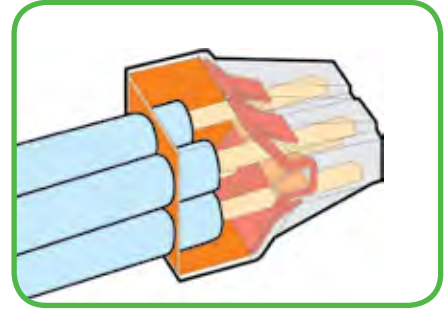

Push-wire connection



Wire removal
Solid - Pull & Twist; Remove wire
Stranded - Cut Wire; Discard connector
 Restrip; Insert wire in new connector

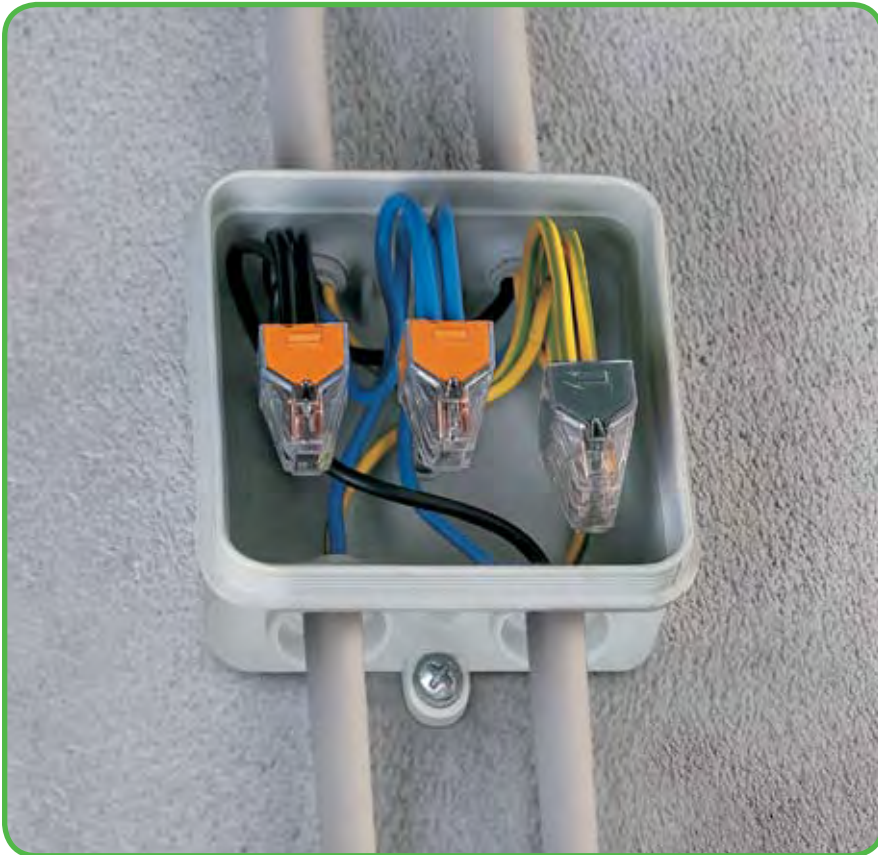

Testing



Integrated test port allows for easy testing of connection integrity.

Applications



Push-wire connectors used in a cable duct with double power outlet.



Packing unit

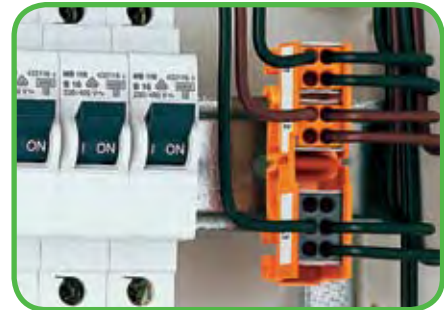

Connectors may be mounted on DIN Rail by using the WAGO fixing carrier.

Push-Wire Connectors for Junction Boxes, (re-use solid wire), Series 773 (Wall-nuts™)

<p>2 x 0.75 – 2.5 mm² "s" 2 x 1.5 – 2.5 mm² "r" 400 V / 4 kV / 2* 24 A</p> <p>12 mm / 0.47 in</p> <p>* Ⓢ</p>	<p>2 x AWG 18 – 12 "sol." 2 x AWG 16 – 12 "rig." 600 V, 20 A ⓈⓈ Max. op. temp. 105°C</p>	<p>4 x 0.75 – 2.5 mm² "s" 4 x 1.5 – 2.5 mm² "r" 400 V / 4 kV / 2* 24 A</p> <p>12 mm / 0.47 in</p> <p>* Ⓢ</p>	<p>4 x AWG 18 – 12 "sol." 4 x AWG 16 – 12 "rig." 600 V, 20 A ⓈⓈ Max. op. temp. 105°C</p>	<p>6 x 0.75 – 2.5 mm² "s" 6 x 1.5 – 2.5 mm² "r" 400 V / 4 kV / 2* 24 A</p> <p>12 mm / 0.47 in</p> <p>* Ⓢ</p>	<p>6 x AWG 18 – 12 "sol." 6 x AWG 16 – 12 "rig." 600 V, 20 A ⓈⓈ Max. op. temp. 105°C</p>
--	--	--	--	--	--

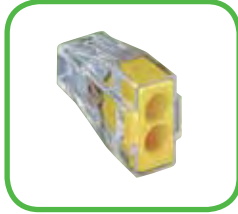

Item No.	Pack.-unit pcs	Item No.	Pack.-unit pcs	Item No.	Pack.-unit pcs
Push-wire connectors for junction boxes, 2-conductor connectors, color of housing transparent, color of cover yellow		Push-wire connectors for junction boxes, 4-conductor connectors, color of housing transparent, color of cover orange		Push-wire connectors for junction boxes, 6-conductor connectors, color of housing transparent, color of cover black	
773-162	100 pc/box	773-164	100 pc/box	773-166	50 pc/box
773-102/VE00-0500	500 pc/bag	773-104/VE00-0500	500 pc/bag	773-166/VE00-0500	500 pc/bag
773-102/VE00-2500	2500 pc/bag	773-104/VE00-2500	2500 pc/bag	773-166/VE00-2500	2500 pc/bag
5101251	10 pc/blister pack	5101252	10 pc/blister pack	5101253	10 pc/blister pack

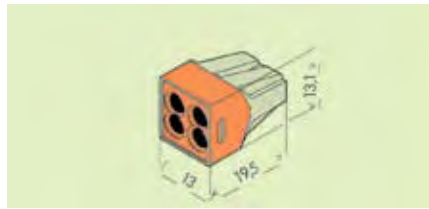
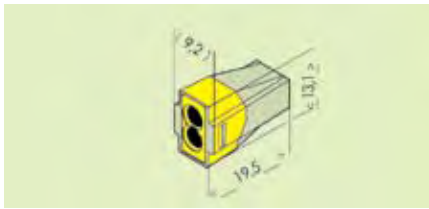

<p>8 x 0.75 – 2.5 mm² "s" 8 x 1.5 – 2.5 mm² "r" 400 V / 4 kV / 2* 24 A</p> <p>12 mm / 0.47 in</p>	<p>8 x AWG 18 – 12 "sol." 8 x AWG 16 – 12 "rig." 600 V, 20 A ⓈⓈ Max. op. temp. 105°C</p>	<p>3 x 0.75 – 2.5 mm² "s" 3 x 1.5 – 2.5 mm² "r" 1 x 0.75 "sol.+rig." 400 V / 4 kV / 2* 24 A</p> <p>12 mm / 0.47 in</p>	<p>3 x AWG 18 – 12 "sol." 3 x AWG 16 – 12 "rig." 1 x AWG 18 "sol.+rig." 600 V, 20 A ⓈⓈ Max. op. temp. 105°C</p>	<p>3 x 1.5 – 6 mm² "s+st" 400 V / 4 kV / 2* 32 A</p> <p>12 - 15 mm / 0.47 - 0.53 in</p>	<p>3 x AWG 14 – 10 "sol." + "str." 600 V, 20 A ⓈⓈ Max. op. temp. 105°C</p>
---	--	--	---	--	--



Item No.	Pack.-unit pcs	Item No.	Pack.-unit pcs	Item No.	Pack.-unit pcs
Push-wire connectors for junction boxes, 8-conductor connectors, color of housing transparent, color of cover dark grey		Push-wire connectors for junction boxes, 4-conductor connectors, filled with contact paste "Alu-Plus", color of housing transparent, color of cover light grey		Push-wire connectors for junction boxes, 3-conductor connectors, color of housing transparent, color of cover red	
773-168	50 pc/box	773-124	100 pc/box	773-173	100 pc/box
773-108/VE00-2500	2500 pc/bag	773-124/VE01-0000	2500 pc/bag	773-173/VE00-0500	500 pc/bag
51013414	10 pc/blister pack			773-173/VE00-2500	2500 pc/bag
				51015201	5 pc/blister pack

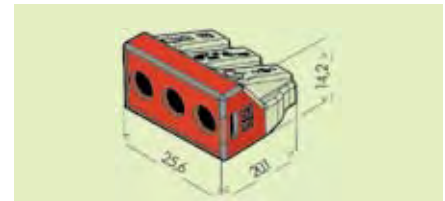
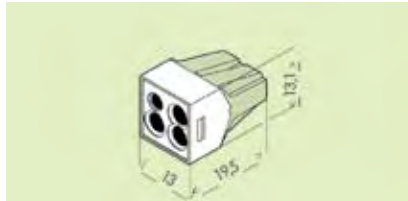
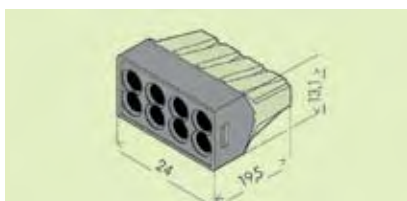

Push-Wire Connectors for Junction Boxes, (re-use solid wire), Series 773 (Wall-nuts™)

<p>2 x 0.75–2.5 mm² "s" 2 x 1.5–2.5 mm² "r" 400 V/4 kV/2* 24 A</p> <p>12 mm / 0.47 in</p> <p>* Ⓢ Ⓜ Ⓝ Ⓟ Ⓠ Ⓡ Ⓢ Ⓣ Ⓤ Ⓥ Ⓦ Ⓧ Ⓨ Ⓩ Ⓩ ⓐ ⓑ ⓓ ⓔ ⓕ ⓖ ⓗ ⓘ ⓙ ⓚ ⓛ ⓜ ⓝ ⓞ ⓟ ⓠ ⓡ ⓢ ⓣ ⓤ ⓥ ⓷ ⓸ ⓹ ⓺ ⓻ ⓼ ⓽ ⓾ ⓿</p>	<p>2 x AWG 18-12 "sol." 2 x AWG 16-12 "rig." 600 V, 20 A Ⓢ</p> <p>12 mm / 0.47 in</p> <p>* Ⓢ Ⓜ Ⓝ Ⓟ Ⓠ Ⓡ Ⓢ Ⓣ Ⓤ Ⓥ Ⓦ Ⓧ Ⓨ Ⓩ Ⓩ ⓐ ⓑ ⓓ ⓔ ⓕ ⓖ ⓗ ⓘ ⓙ ⓚ ⓛ ⓜ ⓝ ⓞ ⓟ ⓠ ⓡ ⓢ ⓣ ⓤ ⓥ ⓷ ⓸ ⓹ ⓺ ⓻ ⓼ ⓽ ⓾ ⓿</p>	<p>4 x 0.75 – 2.5 mm² "s" 4 x 1.5 – 2.5 mm² "r" 400 V/4 kV/2* 24 A</p> <p>12 mm / 0.47 in</p> <p>* Ⓢ Ⓜ Ⓝ Ⓟ Ⓠ Ⓡ Ⓢ Ⓣ Ⓤ Ⓥ Ⓦ Ⓧ Ⓨ Ⓩ Ⓩ ⓐ ⓑ ⓓ ⓔ ⓕ ⓖ ⓗ ⓘ ⓙ ⓚ ⓛ ⓜ ⓝ ⓞ ⓟ ⓠ ⓡ ⓢ ⓣ ⓤ ⓥ ⓷ ⓸ ⓹ ⓺ ⓻ ⓼ ⓽ ⓾ ⓿</p>	<p>4 x AWG 18 – 12 "sol." 4 x AWG 16–12 "rig." 600 V, 20 A Ⓢ 600 V, 20 A ⓕ</p> <p>12 mm / 0.47 in</p> <p>* Ⓢ Ⓜ Ⓝ Ⓟ Ⓠ Ⓡ Ⓢ Ⓣ Ⓤ Ⓥ Ⓦ Ⓧ Ⓨ Ⓩ Ⓩ ⓐ ⓑ ⓓ ⓔ ⓕ ⓖ ⓗ ⓘ ⓙ ⓚ ⓛ ⓜ ⓝ ⓞ ⓟ ⓠ ⓡ ⓢ ⓣ ⓤ ⓥ ⓷ ⓸ ⓹ ⓺ ⓻ ⓼ ⓽ ⓾ ⓿</p>	<p>6 x 0.75 – 2.5 mm² "s" 6 x 1.5 – 2.5 mm² "r" 400 V/4 kV/2* 24 A</p> <p>12 mm / 0.47 in</p> <p>* Ⓢ Ⓜ Ⓝ Ⓟ Ⓠ Ⓡ Ⓢ Ⓣ Ⓤ Ⓥ Ⓦ Ⓧ Ⓨ Ⓩ Ⓩ ⓐ ⓑ ⓓ ⓔ ⓕ ⓖ ⓗ ⓘ ⓙ ⓚ ⓛ ⓜ ⓝ ⓞ ⓟ ⓠ ⓡ ⓢ ⓣ ⓤ ⓥ ⓷ ⓸ ⓹ ⓺ ⓻ ⓼ ⓽ ⓾ ⓿</p>	<p>6 x AWG 18 – 12 "sol." 6 x AWG 16 – 12 "rig." 600 V, 20 A Ⓢ 600 V, 20 A ⓕ</p> <p>12 mm / 0.47 in</p> <p>* Ⓢ Ⓜ Ⓝ Ⓟ Ⓠ Ⓡ Ⓢ Ⓣ Ⓤ Ⓥ Ⓦ Ⓧ Ⓨ Ⓩ Ⓩ ⓐ ⓑ ⓓ ⓔ ⓕ ⓖ ⓗ ⓘ ⓙ ⓚ ⓛ ⓜ ⓝ ⓞ ⓟ ⓠ ⓡ ⓢ ⓣ ⓤ ⓥ ⓷ ⓸ ⓹ ⓺ ⓻ ⓼ ⓽ ⓾ ⓿</p>
--	--	--	--	--	--



Item No.	Pack.-unit pcs	Item No.	Pack.-unit pcs	Item No.	Pack.-unit pcs
Push-wire connectors for junction boxes, 2-conductor connectors, color of housing transparent, color of cover green		Push-wire connectors for junction boxes, 4-conductor connectors, color of housing transparent, color of cover green		Push-wire connectors for junction boxes, 6-conductor connectors, color of housing transparent, color of cover green	
773-112	100 pc/box	773-114	100 pc/box	773-116	50 pc/box

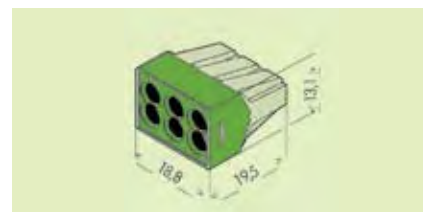
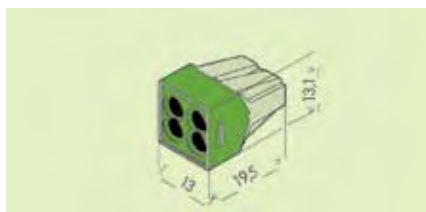
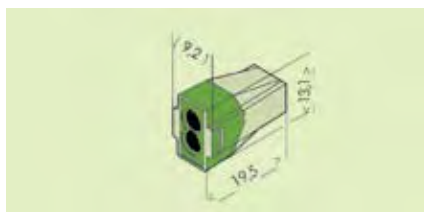

<p>8 x 0.75 – 2.5 mm² "s" 8 x 1.5 – 2.5 mm² "r" 400 V/4 kV/2* 24 A</p> <p>12 mm / 0.47 in</p> <p>* Ⓢ Ⓜ Ⓝ Ⓟ Ⓠ Ⓡ Ⓢ Ⓣ Ⓤ Ⓥ Ⓦ Ⓧ Ⓨ Ⓩ Ⓩ ⓐ ⓑ ⓓ ⓔ ⓕ ⓖ ⓗ ⓘ ⓙ ⓚ ⓛ ⓜ ⓝ ⓞ ⓟ ⓠ ⓡ ⓢ ⓣ ⓤ ⓥ ⓷ ⓸ ⓹ ⓺ ⓻ ⓼ ⓽ ⓾ ⓿</p>	<p>8 x AWG 18 – 12 "sol." 8 x AWG 16 – 12 "rig." 600 V, 20 A Ⓢ 600 V, 20 A ⓕ</p> <p>12 mm / 0.47 in</p> <p>* Ⓢ Ⓜ Ⓝ Ⓟ Ⓠ Ⓡ Ⓢ Ⓣ Ⓤ Ⓥ Ⓦ Ⓧ Ⓨ Ⓩ Ⓩ ⓐ ⓑ ⓓ ⓔ ⓕ ⓖ ⓗ ⓘ ⓙ ⓚ ⓛ ⓜ ⓝ ⓞ ⓟ ⓠ ⓡ ⓢ ⓣ ⓤ ⓥ ⓷ ⓸ ⓹ ⓺ ⓻ ⓼ ⓽ ⓾ ⓿</p>	<p>4 x 0.75 – 2.5 mm² "s" 4 x 1.5 – 2.5 mm² "r" 400 V/4 kV/2* 24 A</p> <p>12 mm / 0.47 in</p> <p>* Ⓢ Ⓜ Ⓝ Ⓟ Ⓠ Ⓡ Ⓢ Ⓣ Ⓤ Ⓥ Ⓦ Ⓧ Ⓨ Ⓩ Ⓩ ⓐ ⓑ ⓓ ⓔ ⓕ ⓖ ⓗ ⓘ ⓙ ⓚ ⓛ ⓜ ⓝ ⓞ ⓟ ⓠ ⓡ ⓢ ⓣ ⓤ ⓥ ⓷ ⓸ ⓹ ⓺ ⓻ ⓼ ⓽ ⓾ ⓿</p>	<p>4 x AWG 18 – 12 "sol." 4 x AWG 16 – 12 "rig." 600 V, 20 A Ⓢ 600 V, 20 A ⓕ</p> <p>12 mm / 0.47 in</p> <p>* Ⓢ Ⓜ Ⓝ Ⓟ Ⓠ Ⓡ Ⓢ Ⓣ Ⓤ Ⓥ Ⓦ Ⓧ Ⓨ Ⓩ Ⓩ ⓐ ⓑ ⓓ ⓔ ⓕ ⓖ ⓗ ⓘ ⓙ ⓚ ⓛ ⓜ ⓝ ⓞ ⓟ ⓠ ⓡ ⓢ ⓣ ⓤ ⓥ ⓷ ⓸ ⓹ ⓺ ⓻ ⓼ ⓽ ⓾ ⓿</p>	<p>Carrier for Push-Wire Connectors</p> <p>Carrier width 18 mm / 0.7 in</p>
--	--	--	--	---

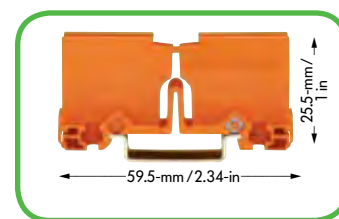

Item No.	Pack.-unit pcs	Item No.	Pack.-unit pcs	Item No.	Pack.-unit pcs
Push-wire connectors for junction boxes, 8-conductor connectors, color of housing transparent, color of cover green		Push-wire connectors for high temperature applications, 4-conductor connectors, color of housing black, color of cover black		Fixing carrier for 4 push-wire connectors	
773-118	50 pc/box	773-514	50 pc/box	orange	773-332 50 pc/box
				light grey	773-331 50 pc/box
				Marker strip, plain	243-110 1 ea

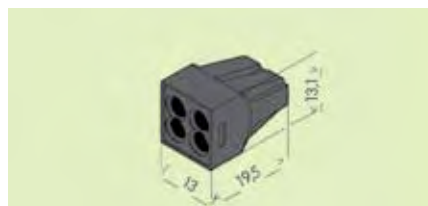
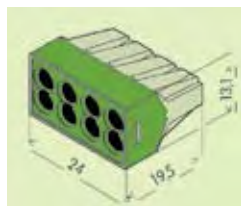



* in grounded (earthed) supply system

3 or 5 Conductor Compact Connectors, Series 222 (Lever-Nuts™)

28 – 12 AWG (stranded and solid)
600 V maximum 
20 A maximum

Strip length:  9 - 10 mm / 0.37 in
Maximum operating temperature: 105° C



28 – 12 AWG (stranded and solid)
600 V maximum 
20 A maximum

Strip length:  9 - 10 mm / 0.37 in
Maximum operating temperature: 105° C

For all connections requiring...

- Stranded / solid wires
- Wide range of wire sizes
- Combination of different wire sizes and types
- Small space consumption
- Built-in test point
- Protection against electrical shock, touch safe
- Low installed cost and safe operation
- Maintenance-free connection



	Item No.	Pack.-unit pcs	Item No.	Pack.-unit pcs
	Push-wire connectors for junction boxes,		Push-wire connectors for junction boxes,	
	3-conductor connectors with CAGE CLAMP® spring pressure connection technology, grey (w/ orange levers)		3-conductor connectors, color of housing transparent, color of cover red	
	222-413	500 pc/bag	773-173	100 pc/box
	222-413/VE00-0050	50 pc/box	773-173/VE00-0500	500 pc/bag
	51015200	5 pc/blister pack	773-173/VE00-2500	2500 pc/bag
			51017356	5 pc/blister pack
Technical Information				
Number of connection points per connector:		3		5
Potentials per connector:		1		1
Height:		14.5 mm / 0.571 in		14.5 mm / 0.571 in
Width:		17 mm / 0.669 in		26.6 mm / 1.047 in
Depth:		20.5 mm / 0.807 in		20.5 mm / 0.807 in
Approvals:				

Easy as 1, 2, 3...



1) Strip wire



2) Push up lever



3) Insert conductor and push down lever

Lighting & "Service" Connectors, Series 224

Installation side 1.0 – 2.5 mm ² -“s” Lighting side 0.5 – 2.5 mm ² -“s+f-st” 400 V/4 kV/2**; 24 A 9 – 11 mm / 0.39 in *	AWG 14 – 12 AWG 20 – 16 300 V, 20 A-	Installation side 2-x-1.0 – 2.5 mm ² -“s” Lighting side 0.5 – 2.5 mm ² -“s+f-st” 400 V/4 kV/2**; 24 A 9 – 11 mm / 0.39 in *	AWG 16 – 14 AWG 20 – 16 300 V, 4 A-
---	--	---	---

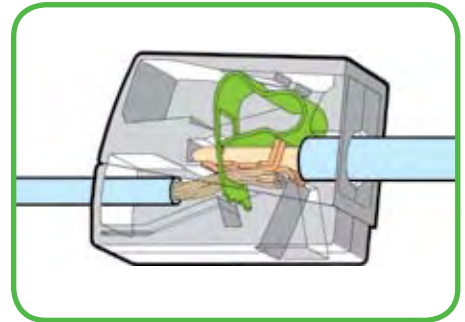

Colour	Item No.	Pack.-unit pcs	Colour	Item No.	Pack.-unit pcs
Lighting connectors, standard version,			2-conductor lighting connectors, standard version,		
continuous service temperature 105°C,			continuous service temperature 105°C,		
grey	224-101	1000 (10 x 100)	white	224-112	1000 (10 x 100)
version for increased continuous service temperature 120°C,			version for increased continuous service temperature 120°C,		
black	224-104	100	black	224-114	100
"Service" connector					
grey	224-201	50			

Stripped length



Strip conductor to 9 – 11 mm / 0.39 in

Dimensions (in mm)

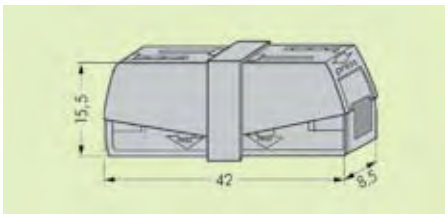
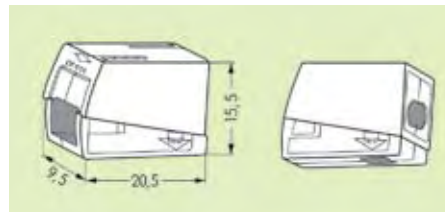
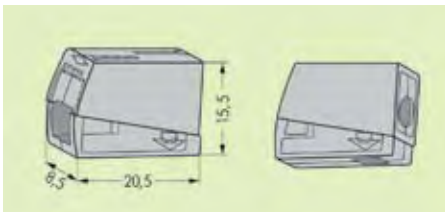

Testing



Testing through separate test slot

Testing



Testing through separate test slot



Connection of conductors (lighting side): Press button fully and insert stripped conductor into square entry and release.



Connection of conductors (installation side): Introduce stripped solid conductor into circular entry and push to stop.

MICRO Push-Wire Connectors for Junction Boxes, Series 243

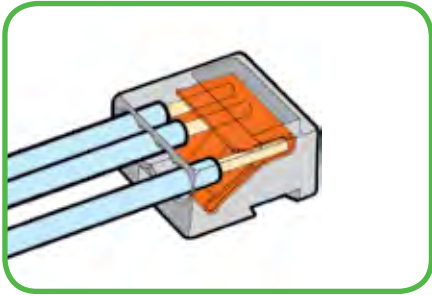

Stripped length

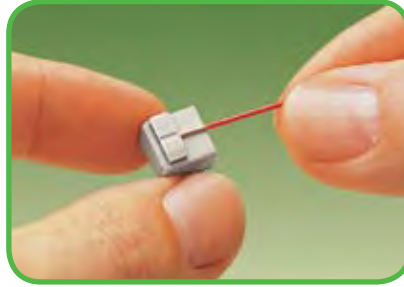

Strip solid wire to 5 – 6 mm / 0.22 in

Connector blocks



Assembly of modular connectors to connector strips

Push-wire connection

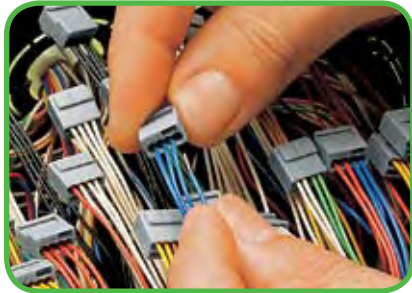

Connection: Insert stripped conductor FULLY.

Push-wire connection



Removal: Hold wire to be removed and twist alternately left and right while pulling the connector

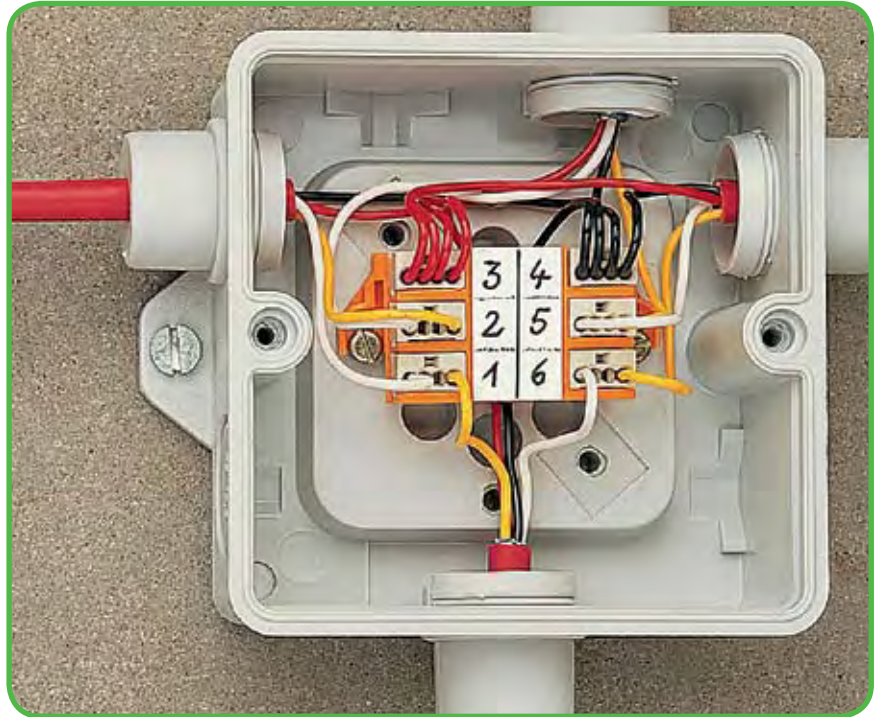

Testing



Test using integrated test ports

Commoning



Commoned connector blocks

















Packing units



Box for use on site (example)
 Contents series 243: 50 pcs 8-conductor
 or 100 pcs 4-conductor



For distribution connectors for **EIB** (Euro Installation Bus) see Full Line Catalog W4, volume 2, page 2.4

MICRO Push-Wire Connectors for Junction Boxes, Fixing Carrier Series 243

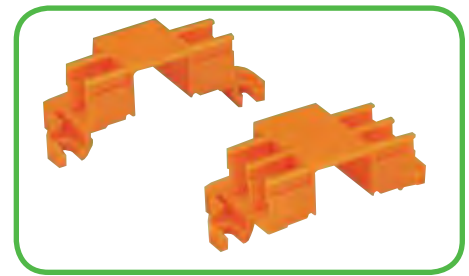
<p>4x0.6 – 0.8 Ø mm "s"*** 100 V/1.5 kV/2 6 A</p> <p>4 x AWG 22 – 20 "sol."*** 125 V, 7 A  150 V, 7 A </p> <p> 5 – 6 mm / 0.22 in *      </p>	<p>8x0.6 – 0.8 Ø mm "s"*** 100 V/1.5 kV/2 6 A</p> <p>8 x AWG 22 – 20 "sol."*** 125 V, 7 A  150 V, 7 A </p> <p> 5 – 6 mm / 0.22 in *     </p>	<p>Fixing carrier for MICRO push-wire connectors</p>
--	--	--



Color	Item No.	Pack.-unit pcs	Color	Item No.	Pack.-unit pcs	Description	Item No.	Pack.-unit pcs
MICRO push-wire connectors for junction boxes, 4-conductor connectors			MICRO push-wire connectors for junction boxes, 8-conductor connectors			Fixing carrier		
dark grey	243-204	1000 (10 x 100)	dark grey	243-208	500 (10 x 50)	for 4 push-wire connectors	243-112	50 (5 x 10)
red	243-804	1000 (10 x 100)	red	243-808	500 (10 x 50)	for 6 push-wire connectors	243-113	50 (5 x 10)
light grey	243-304	1000 (10 x 100)	light grey	243-308	500 (10 x 50)	Marker strip, plain	243-110	1
yellow	243-504	1000 (10 x 100)	yellow	243-508	500 (10 x 50)			

<p>4x 0.4 – 0.5 Ø mm "s" 100 V/1.5 kV/2 6 A</p> <p> 5 – 6 mm / 0.22 in *  </p>	<p>4 x AWG 26 – 24 "sol."</p>
---	-------------------------------



Color	Item No.	Pack.-unit pcs
MICRO push-wire connector for junction boxes, 4-conductor connector		
transparent	243-144	1000 (10 x 100)

Dimensions (in mm)

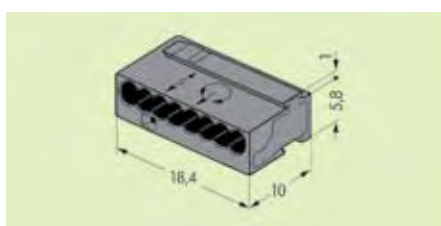
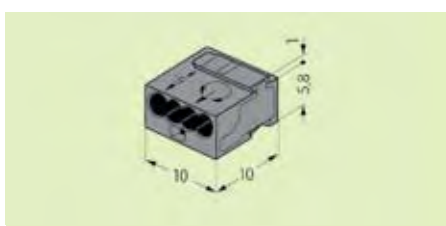

Inserting a MICRO push-wire connector for junction boxes into the carrier

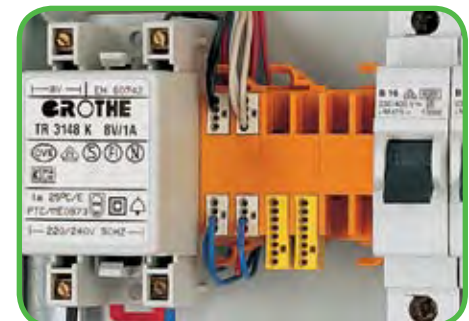



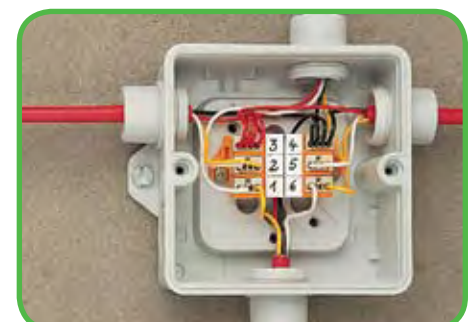

Example of doorbell application – mounted on DIN 35 rail



Typical application in a terminal box for burglar alarm – screw fixing

* You can find approvals on the Internet at www.wago.us
 **When using wires of the same diameter only, 0.5 Ø mm/AWG 24 or 1.0 Ø mm/AWG 18 are also possible

Terminal Blocks for Chassis Mounting, Series 862

4 x 0.5 – 4 mm ² 500 V/6 kV/2 32 A	4 x AWG 20 –12 300 V, 20 A 600 V, 5 A ® 	4 x 0.5 – 4 mm ² 500 V/6 kV/2 32 A	4 x AWG 20 –12 300 V, 20 A 600 V, 5 A ® 
 10 – 11 mm / 0.41 in		 10 – 11 mm / 0.41 in	

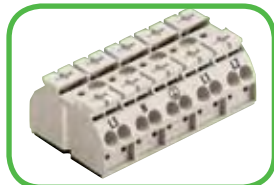







Available in black and white



2 poles / 8 connection points



3 poles / 12 connection points



without ground/ earth contact	with ground/ earth contact	Item No. black	Item No. white	Pack.-unit pcs	Item No. black	Item No. white	Pack.-unit pcs
for fastening screw 3 mm / 0.118 in Ø or for self tapping screw 2.9 mm / 0.114 in Ø from top							
without marking							
	L1-N (pre-marked)	862-0552	862-0652	500			
	N-L1 (pre-marked)	862-1552	862-1652	500			
		862-2552	862-2652	500			
for self tapping screw 2.9 mm / 0.114 mm Ø from below							
without marking							
	L1-N (pre-marked)	862-0562	862-0662	500			
		862-1562	862-1662	500			
		862-2562	862-2662	500			
1 snap-in foot per pole							
without marking							
	L1-N (pre-marked)	862-0532	862-0632	500			
		862-1532	862-1632	500			
		862-2532	862-2632	500			
for fastening screw 3 mm / 0.008 in Ø or for self tapping screw 2.9 mm / 0.114 in Ø from top							
without marking							
	PE-N-L1 (pre-marked)				862-0503	862-0603	250
	N-PE-L1 (pre-marked)				862-1503	862-1603	250
	(pre-marked) N-PE-L1				862-2503	862-2603	250
	(pre-marked) PE-N-L1				862-8503	862-8603	250
					862-9503	862-9603	250
1 snap-in foot per pole							
without marking							
	PE-N-L1 (pre-marked)				862-0533	862-0633	250
					862-1533	862-1633	250
	N-PE-L1 (pre-marked)				862-2533	862-2633	250
	(pre-marked) N-PE-L1				862-8533	862-8633	250
	(pre-marked) PE-N-L1				862-9533	862-9633	250
snap-in feet at pos. 1+3							
without marking							
	PE-N-L1 (pre-marked)				862-0593	862-0693	250
					862-1593	862-1693	250
	N-PE-L1 (pre-marked)				862-2593	862-2693	250
	(pre-marked) N-PE-L1				862-8593	862-8693	250
	(pre-marked) PE-N-L1				862-9593	862-9693	250
Accessories							
Comb-type jumper bar , can easily be inserted into the wire entry, 32 A 		Test plug , with cable 500 mm / 1'77" 			Test plug , with cable 500 mm / 1'77" 		
	862-482	5		2 mm / 0.079 in Ø, red 210-136	1	2.3 mm / 0.091 in Ø, yellow 210-137	50 (5 x 10)
Screwdriver , with partially insulated shaft 		Marker strip , white, plain for central marking; 			Marker strip , white, plain for central marking; 		
	(3.5 x 0.5) mm (.14 x .0025) in 210-620	1		7.5 mm wide, on roll, 50 m long 709-178	1	7.5 mm wide, on roll, 300 m long 709-188	1

Cost-effective features:

The new 862 Series chassis mount terminal block was developed specifically to minimize wiring costs, while accommodating requirements for easy mounting, multiple connection points, marking, and handling.

- The new 862 Series allows the connection of up to four conductors from wire size 20 to 12 AWG. Due to the multiple connection points per pole, different wire sizes can be used within the same terminal block position.
- The CAGE CLAMP®S termination technology allows solid conductors, stranded conductors with ferrules, or ultrasonically bonded conductors to be easily connected by simply pushing the conductor into the contact.
- An integrated push button, with molded-in slots, accommodates fast and easy wiring of all conductor types - either by hand, or with a slotted tip/Phillips screwdriver.
- Convenient automatic grounding contact available as an option (see page 3 for illustration).
- Snap-in mounting feet for fast assembly (see back page for illustration).
- Flexible marking options with standard marking (pre-marked), marker strip, or custom marked per your specifications with large quantity orders.
- Built-in test points simplify testing with 2 mm / 0.079 in diameter test plug.

Terminal Blocks for Chassis Mounting, Series 862

4 x 0.5 – 4 mm ² 500 V/6 kV/2 32 A	4 x AWG 20 –12 300 V, 20 A 600 V, 5 A UL	4 x 0.5 – 4 mm ² 500 V/6 kV/2 32 A	4 x AWG 20 –12 300 V, 20 A 600 V, 5 A UL
 10 – 11 mm / 0.41 in		 10 – 11 mm / 0.41 in	

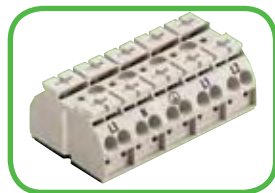

Available in black and white



4 poles /16 connection points

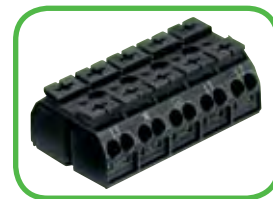

5 poles /20 connection points

without ground/ earth contact	with ground/ earth contact	Item No. black	Item No. white	Pack.-unit pcs	Item No. black	Item No. white	Pack.-unit pcs
for fastening screw 3 mm Ø or for self tapping screw 2.9 mm Ø from top							
without marking							
		862-0504	862-0604	200			
	PE-N-L1-L2 (pre-marked)	862-1504	862-1604	200			
	N-PE-L1-L2 (pre-marked)	862-2504	862-2604	200			
	(pre-marked) N-PE-L1-L2	862-8504	862-8604	200			
	(pre-marked) PE-N-L1-L2	862-9504	862-9604	200			
1 snap-in foot per pole							
without marking							
		862-0534	862-0634	200			
	PE-N-L1-L2 (pre-marked)	862-1534	862-1634	200			
	N-PE-L1-L2 (pre-marked)	862-2534	862-2634	200			
	(pre-marked) N-PE-L1-L2	862-8534	862-8634	200			
	(pre-marked) PE-N-L1-L2	862-9534	862-9634	200			
snap-in feet at pos. 1+4							
without marking							
		862-0594	862-0694	200			
	PE-N-L1-L2 (pre-marked)	862-1594	862-1694	200			
	N-PE-L1-L2 (pre-marked)	862-2594	862-2694	200			
	(pre-marked) N-PE-L1-L2	862-8594	862-8694	200			
	(pre-marked) PE-N-L1-L2	862-9594	862-9694	200			
for fastening screw 3 mm Ø or for self tapping screw 2.9 mm Ø from top							
without marking							
					862-0505	862-0605	200
	PE-N-L1-L2-L3 (pre-marked)				862-1505	862-1605	200
	L3-N-PE-L1-L2 (pre-marked)				862-2505	862-2605	200
	(pre-marked) L3-N-PE-L1-L2				862-8505	862-8605	200
	(pre-marked) PE-N-L1-L2-L3				862-9505	862-9605	200
1 snap-in feet at pos. 2+4							
without marking							
					862-0525	862-0625	200
	PE-N-L1-L2-L3 (pre-marked)				862-1525	862-1625	200
	L3-N-PE-L1-L2 (pre-marked)				862-2525	862-2625	200
	(pre-marked) L3-N-PE-L1-L2				862-8525	862-8625	200
	(pre-marked) PE-N-L1-L2-L3				862-9525	862-9625	200
snap-in feet at pos. 1+3+5							
without marking							
					862-0515	862-0615	200
	PE-N-L1-L2-L3 (pre-marked)				862-1515	862-1615	200
	L3-N-PE-L1-L2 (pre-marked)				862-2515	862-2615	200
	(pre-marked) L3-N-PE-L1-L2				862-8515	862-8615	200
	(pre-marked) PE-N-L1-L2-L3				862-9515	862-9615	200

Ground (earth) contact



- Makes an automatic contact to the mounting plate
- Varnish coating is penetrated automatically

Conductor connection



- Four conductors per pole
- For solid and flexible conductors
- Mixed wiring with solid and flexible conductors of different cross sections

Marking and testing



- Marking by direct printing and/or marker strips
- Testing with test plug 2 mm Ø

Terminal Blocks for Chassis Mounting, Series 862

Fastening Options

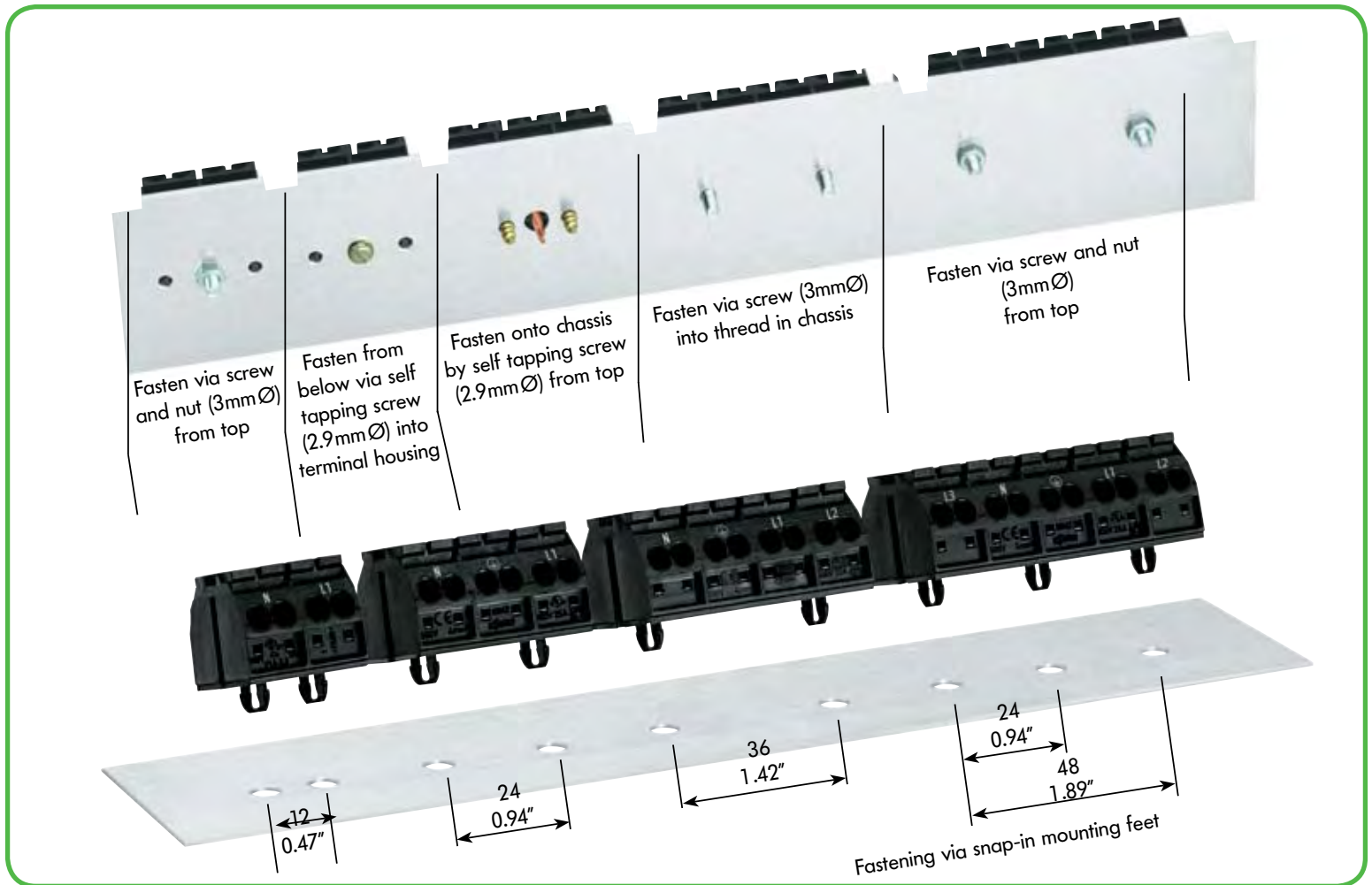

Mounting foot,

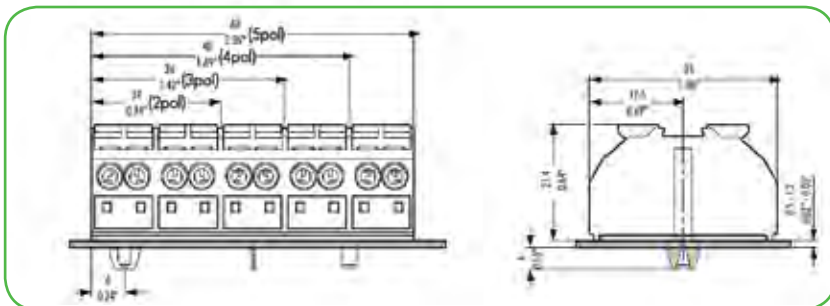

Item No.	Pack.-unit pcs
Mounting foot for DIN Rail mounting,	
209-120	25

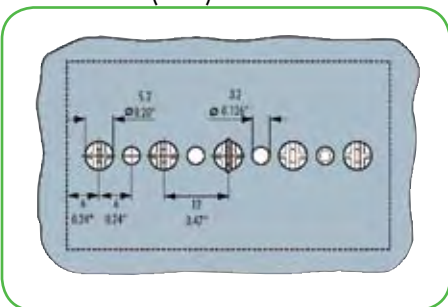

Dimensions (mm)

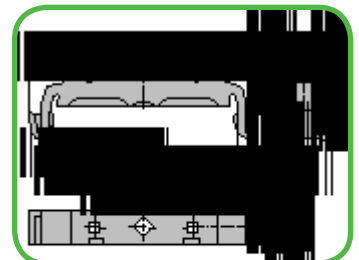

Dimensions (in mm)











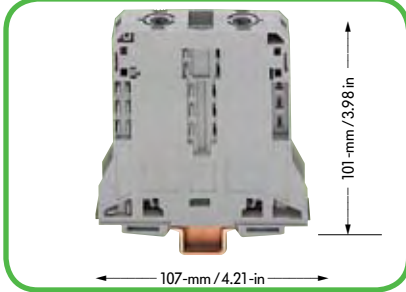





95 mm²/AWG 000 Rail-Mounted High Current Terminal Blocks Series 285

25 – 95 mm² AWG 4 – 000
 1000 V/8 kV/3- 600 V, 200 A 
 232 A 600 V, 210 A 

Terminal block width 25 mm / 0.98 in

*   



Colour	Item No.	Pack.-unit pcs
2-conductor through terminal blocks		
grey	285-195 	5
blue	285-194 	5
light grey 	285-995 	5
2-conductor ground (earth) terminal blocks		
green-yellow	285-197 	5
green-yellow 	285-197/999-950 	5
Accessories Appropriate marking system WMB		
Adjacent jumper , insulated, I _N 232 A for 1 jumper		
	I _N 192 A for 2 to 4 jumper	
	grey 285-495 25	
Voltage tap , I _N 57 A, 0.2 - 10/16 mm ²		
	Module width 20 mm / 0.787 in	
	grey 285-407 5	
Hex wrench with partially insulated shaft		
	8 mm/0.32 in	
	285-172 1	
Touch protection cover , for unused clamping units and jumper slots		
	yellow 285-169 25	
Protective warning marker , with high voltage symbol, for 5 terminal blocks		
	yellow 285-170 50 (2-x-25)	
 Suitable for Ex e II applications		
	25 – 95 mm ² AWG 4 – 000	
	750 V~, 195 A	
	20 – 70 mm ² AWG 2 – 00	
	for ground (earth) conductor terminal blocks	

Wire connection



Counter-clockwise rotation using a hex wrench. Latch holds clamp in open position.



Introduce stripped wire (stripped length 35 mm!) into the clamping unit up to the stop and hold it in position . . .



. . . A small counter-clockwise rotation releases the latch. Once the operating tool has been removed the conductor is safely clamped.

Commoning

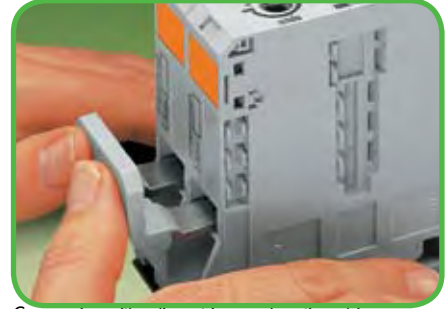

Commoning with adjacent jumper. Insertion of jumper above the conductor entry hole, without tools. Rated cross section is still 95 mm²/AWG 000.

Testing/Protective warning marker



- Testing with test plug 4 mm/0.157 in diameter.
- Protective warning marker may indicate: Attention! Voltage may be present despite main circuit being switched off!

Voltage tap



Reliable and simple tap directly onto the power supply. Insert the unwired tap before opening the pressure spring.

Touch protection



Jumper contact slots can also be sealed individually.

DIN Rail Mount Outlet Boxes, CPO Series

Dimensions:

Width: 60.2 mm / 2.37 in

Height: 61.1 mm / 2.41 in

Length with connector: 108.7 mm / 4.28 in

The WAGO CPO Series of DIN rail mount Convenient Power Outlets provides a convenient power source in the control cabinet, for laptops, solder irons, electrical screwdrivers, test equipment, lighting, etc. The CPO Series significantly reduces time, cost and frustration compared to the manual assembly of outlet boxes.

- Ground pin located on top to prevent loose metal objects from inadvertently shorting the hot and neutral pins.
- Power input terminal blocks with CAGE CLAMP® connection technology for fast, easy and maintenance-free wiring.
- Built-in test point for easy troubleshooting.
- Power input terminal block is pre-marked for safe wiring.
- Compact design takes up less space.
- Complete family of solutions to choose from.



Item Number	51015045	51012222	51018358	51012216
Pack.-unit pcs	1	1	1	1
Description				
	Ground Fault Circuit Interrupt Outlet with load terminals to protect equipment downstream	Surge-Protected Outlet	Switched Box	European "Schuko" Outlet
Technical Data				
Rated Voltage	120 V	120 V	120 V	250 V
Rated Current	15 A	15 A	15 A	15 A
Rated AWG	28 - 12	28 - 12	28 - 12	28 - 12
Mounting	35 mm DIN rail	35 mm DIN rail	35 mm DIN rail	35 mm DIN rail
Approvals	UL Pending	UL Pending	UL	

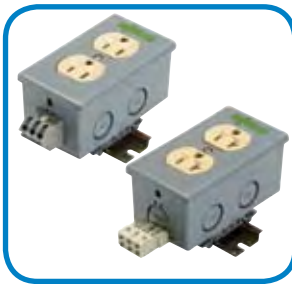

Item Number	51017543	51012218	51018302	51012356	51018351	51012352	51018377	51012312
Pack.-unit pcs	1	1	1	1	1	1	1	1
Description								
	Duplex Outlet	20 Amp Duplex Outlet	Isolated Ground Outlet - single connection per pole	Isolated Ground Outlet - double connection per pole	Ground Fault Circuit Interrupt Outlet	Ground Fault Circuit Interrupt Outlet; right angle connector to reduce wiring space	Switched Controlled Outlet	Outlet with separate switch
Technical Data								
Rated Voltage	120 V	120 V	125 V	125 V	120 V	120 V	120 V	120 V
Rated Current	15 A	20 A	15 A	15 A	15 A	15 A	15 A	20 A
Rated AWG	28 - 12	28 - 12	28 - 12	28 - 12	28 - 12	28 - 12	28 - 12	28 - 12
Mounting	35 mm DIN rail	35 mm DIN rail	35 mm DIN rail	35 mm DIN rail	35 mm DIN rail	35 mm DIN rail	35 mm DIN rail	35 mm DIN rail
Approvals	UL	UL	UL	UL Pending	UL	UL Pending	UL	UL Pending

Relay Socket with Small Switching Relay, Pluggable, Series 788

Relay socket with DC relay and status indication; 1 or 2 changeover contacts

0.34 – 2.5 mm² AWG 22 – 14
Dimensions (W x H x L) 15 x 53 x 86 mm
Relay height 15 mm

 US File E 175199

Relay socket with DC relay and status indication; 1 or 2 changeover contacts

0.34 – 2.5 mm² AWG 22 – 14
Dimensions (W x H x L) 15 x 63 x 86 mm
Relay height 25 mm

 US File E 175199

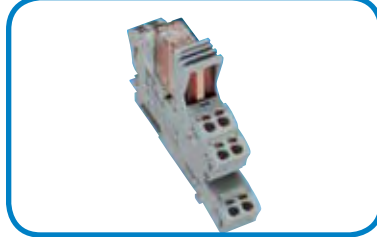
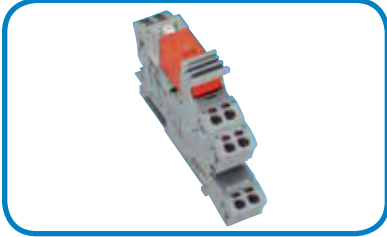

Jumpering made easy









Switch status indication

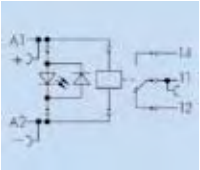
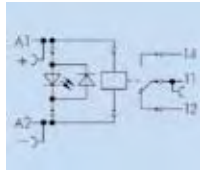
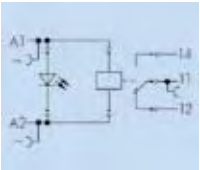
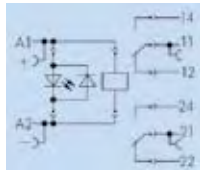
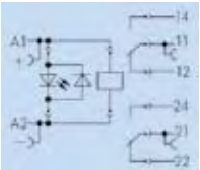

Pluggable relays

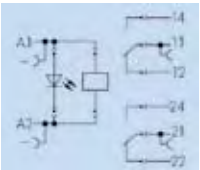

CAGE CLAMP®S

Item No.	Pack.-unit pcs	Item No.	Pack.-unit pcs
Single Pole/Double Throw 		Single Pole Double Throw 	
788-303 DC 12 V	1	788-323 DC 12 V	1
788-304 DC 24 V	1	788-324 DC 24 V	1
788-305 DC 48 V	1	788-528 AC 230 V	1
788-306 DC 60 V	1		
788-307 DC 110 V	1		
Single Pole Double Throw 		Double Pole Double Throw 	
788-506 AC 24 V	1	788-333 DC 12 V	1
788-507 AC 115 V	1	788-334 DC 24 V	1
788-508 AC 230 V	1	788-337 DC 110 V	1
		788-538 AC 230 V	1
Double Pole Double Throw 		Accessories, Series 788 appropriate marking system WMB/WSB	
788-311 DC 12 V	1	 Comb type jumper bar, 2-way	
788-312 DC 24 V	1	788-113	
788-313 DC 48 V	1		
788-314 DC 60 V	1	859-402	
788-315 DC 110 V	1		
Double Pole Double Throw 		Status indication, with free-wheeling diode 	
788-512 DC 24 V	1	788-120 DC 24-V	
788-515 DC 115 V	1	788-121 DC 48-V	
788-516 DC 230 V	1	788-122 DC 110-V	
		788-123 AC 24-V	
		788-124 AC 115-V	
		788-125 AC 230-V	
Socket without relay for switching relay (15 mm high) 		Socket without relay for switching relay (25 mm high) 	
788-100	1	788-101	1
RT 15, SPDT		RT 25, SPDT	
788-102	1	788-103	1
RT 15, DPDT		RT 25, DPDT	

Non-degrading Silicon Surge Suppression Devices, WAGO PROTECT Series

<p>Silicon Surge Suppression Devices</p> <p>WAGO PROTECT - 120 Vac, 240 Vac, 24 Vdc</p> <p>AWG 28 – 12</p>  <p>8 – 9 mm</p>		
---	--	--

Non-Degrading Silicon Surge Suppression

The WAGO-PROTECT series DIN rail mount surge suppressors are high speed, high current, solid state devices designed to protect sensitive electronic equipment (PLCs, PCs, etc.) from transient over voltages present on AC/DC power lines. Powered by patented Silicon Avalanche Suppressor Diode technology from Transtector, these suppressors provide the utmost in protection without degradation - unlike MOV based technology.

Features:

- Pluggable surge function module for easy maintenance and replacement
- Fast, vibration-proof, and maintenance-free wiring with CAGE CLAMP®
- LED fail mode indication as well as relay alarm output connection
- Built-in test points for easy troubleshooting and maintenance



	Item No.	Pack.-unit pcs	Item No.	Pack.-unit pcs	Item No.	Pack.-unit pcs
	WAGO Protect 120 , Non-degrading silicon surge suppression devices, 120 Vac pluggable module, with receptacle base		WAGO Protect 240 , Non-degrading silicon surge suppression devices, 240 Vac pluggable module, with receptacle base		WAGO Protect 24 , Non-degrading silicon surge suppression devices, 24 Vdc pluggable module, with receptacle base	
	51018058	1 ea	51018059	1 ea	51017375	1 ea
Nominal Voltage	120 Vac		240 Vac		24 Vdc	
Max. Continuous Voltage	140 V RMS		280 V RMS		36 V RMS	
Max. Nominal Current	20 A		20 A		20 A	
Leakage Current	None		None		None	
Voltage Protection Level (min./max. V Peak)	220/330 Vp		440/660 Vp		60 Vp	
Power Dissipation (based on IEEE ANSI c62.41-1991)						
at 20/80µs (transient waveform lightning induced)	1.3kA		1.3kA		2kA	
at 10/100µs (transient waveform other source induced)	400 A		400 A		600 A	
Response Time (nano seconds)	<5ns		<5ns		<5ns	
Temperature Range	-40°C to +85°C		-40°C to +85°C		-40°C to +85°C	
Ingress Protection Level (IEC)	IP 20 (touch safe)		IP 20 (touch safe)		IP 20 (touch safe)	
Insulating Housing	PA		PA		PA	
Wire Termination Type	CAGE CLAMP®		CAGE CLAMP®		CAGE CLAMP®	
Wire Strip Length	8 - 9 mm		8 - 9 mm		8 - 9 mm	
Wire Range	28 - 12 AWG		28 - 12 AWG		28 - 12 AWG	
Wiring Configurations	L-L, L-N		L-L, L-N		L-L, L-N	
Dimensions (mm)	82.5 H x 73 L x 22 W		82.5 H x 73 L x 22 W		82.5 H x 73 L x 31 W	
Approvals	UL 1449 2nd Edition		UL 1449 2nd Edition		Less than 50 Vdc	
	CSA C22-2		CSA C22-2		N/A	

Carrier Rails, Series 210

Carrier rail 35 x 7.5 mm,
1-mm/0.039 in thick,
acc. to EN 50022,
Steel, zinc-plated and yellow chromated
I_N 76 A (referred to a length of 1 m)

Carrier rail 35 x 15 mm,
1.5 mm/0.059 in and 2.3 mm/0.091 in thick,
acc. to EN 50022,
Steel, zinc-plated and yellow chromated
I_N 125 A (referred to a length of 1 m)

Carrier rail 35 x 15 mm,
2.3 mm/0.091 in thick,
acc. to EN 50022,
Copper, unplated
I_N 309 A (referred to a length of 1 m)

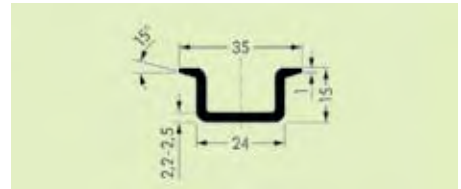
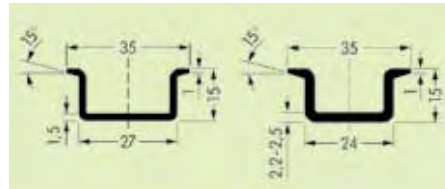
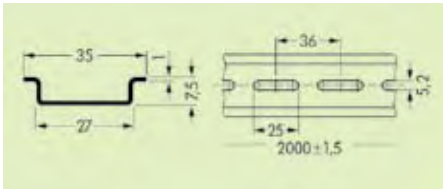
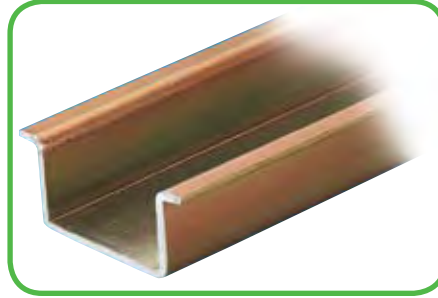
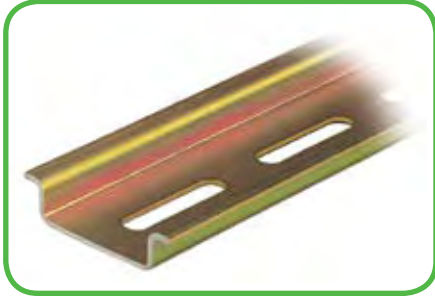

Item No.	Pack.-unit pcs	Item No.	Pack.-unit pcs	Item No.	Pack.-unit pcs
Steel rail 35 x 7.5 mm, 1 mm/0.039 in th., unslotted 2 m/6'6" long 210-113	10	Steel rail 35 x 15 mm, 2 m/6'6" long 1.5 mm thick 210-114 unslotted	10	Copper carrier rail 35 x 15 mm, 2.3 mm/0.091 in thick, unslotted	
Steel rail 35 x 7.5 mm, 1 mm/0.039 in th., slotted 2 m/6'6" long 210-112	10	1.5 mm thick 210-197 slotted	10	2 m/6'6" long 210-198	10
		2.3 mm thick 210-118 unslotted	10		

Angled support bracket
Steel, zinc-plated and yellow chromated

End Stop

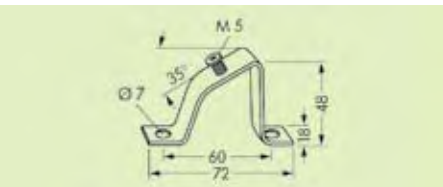
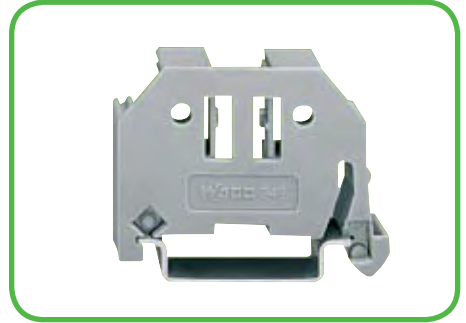

Item No.	Pack.-unit pcs	Item No.	Pack.-unit pcs
Angled support bracket, without screw 210-148	10	6 mm wide 249-116	100
Screw M 5 x 8 210-149	100 (5 x 20)	10 mm wide 249-117	100

Operating Tools, Series 210, Series 209

<p>Screwdrivers with partially insulated shaft for optimum handling of CAGE CLAMP® connection in terminal blocks and connectors</p>	<p>Multipole operating tools for front-entry terminal blocks (insulated)</p>	<p>Screwdrivers (DIN 5264) for optimum handling of CAGE CLAMP® connection in terminal blocks and connectors</p>
--	---	--



Item No.	Pack.-unit pcs	Item No.	Pack.-unit pcs	Item No.	Pack.-unit pcs
Screwdriver, with partially insulated shaft, blade 2.5 x 0.4 mm/0.098 x 0.016 in suitable for series 218, 233, 234, 235, 250, 253, 279, 733, 734, 735, 770, 2001		Operating tool, solid non-conducting material suitable for series 279		Screwdriver, short, blade 3.5 x 0.5 mm/0.138 x 0.020 in suitable for series 231, 232, 236, 255, 256, 257, 264, 280, 281, 721, 722, 736, 737, 738, 742, 745, 804, 869, 2002, 2004	
210-619	1	1-way 209-129	1	210-257	1
		suitable for series 279			
Screwdriver, with partially insulated shaft, blade 3.5 x 0.5 mm/0.137 x 0.020 in suitable for series 231, 232, 236, 255, 256, 257, 264, 280, 281, 721, 722, 736, 737, 738, 742, 745, 804, 869, 2002, 2004		2-way 279-432	1	Screwdriver, short angled, blade 3.5 x 0.5 mm/0.138 x 0.020 in specially suitable for sensor and actuator terminal blocks of series 280 or for series 231, 232, 236, 255, 256, 257, 264, 280, 281, 721, 722, 736, 737, 738, 742, 745, 804, 869, 2002, 2004	
210-620	1	3-way 279-433	1	210-258	1
		10-way 279-440	1		
Screwdriver, with partially insulated shaft, blade 5.5 x 0.8 mm/0.217 x 0.031 in suitable for series 282, 283, 284, 285, 745, 2006, 2010, 2016		suitable for series 264*, 280, 281**			
210-621	1	1-way 209-130	1		
		2-way 280-432	1		
Screwdriver, with partially insulated shaft, - set -, consists of 210-619, 210-620 und 210-621		3-way 280-433	1		
210-622	1	4-way 280-434	1		
		5-way 280-435	1		
		6-way 280-436	1		
		7-way 280-437	1		
		8-way 280-438	1		
		9-way 280-439	1		
		10-way 280-440	1		
		suitable for series 281			
		5-way 281-440	1		
		* only 1- and 2-way			
		** only up to 3-way			

Application notes



Set of screwdrivers in a box



Commoning of front-entry through terminal blocks with comb type jumper bars with the aid of a 10-way operating tool



The blade dimensions of the a. m. screwdrivers (DIN 5264) are particularly appropriate for easy front-entry sensor and actuator terminal blocks of series 280

Voltage Tester, Testboy and Banana Plugs, Series 206, Series 215

<p>Voltage tester Profipol 12 V to 400 V AC 12 V to 500 V DC</p> <p>Weight 138 g / 0.304 lbs</p>	<p>Testboy</p>	<p>Banana plugs for sockets Ø 4 mm 0.08 – 2.5 mm² AWG 28 – 14 42 V 20 A L 9 – 11 mm / 0.39 in</p>
--	-----------------------	---

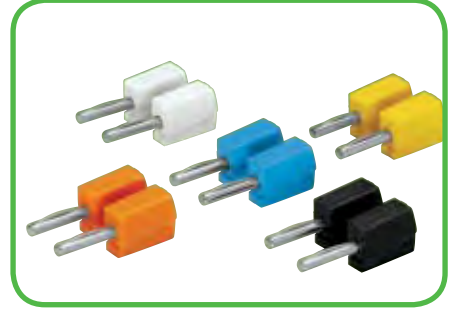
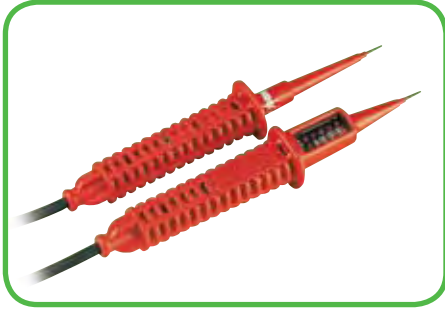

Item No.	Pack.-unit pcs	Item No.	Pack.-unit pcs	Item No.	Pack.-unit pcs
Voltage tester Profipol		Testboy, with integrated flashlight		Banana plugs, for sockets Ø 4 mm	
206-802	1	206-804	1	color mixed	215-111 50
				orange, blue, yellow, white, black	
Voltage range	AC 12V to 400V DC 12V to 500V	Voltage range	120V up to AC 1000V	Banana plugs, for sockets Ø 4 mm	
LED indication AC	12V, 50V, 100V, 230V, 400V			orange	215-211 50
DC	12V, 60V, 120V, 280V, 500V			red	215-212 50
Type of protection	IP 65			black	215-311 50
Operating time	30 s max.			green	215-411 50
Temperature range	-10° up to + 50°C			yellow	215-511 50
				blue	215-711 50
				grey	215-811 50
				green-yellow	215-911 50

Application notes



Voltage testing of push-wire connectors



A device that will reliably detect AC voltages in cables, sockets, fuses, switches, connector boxes, etc.



Connection of conductors:
Press button fully and insert stripped conductor into square entry and release

- LED band provides clear voltage range readings
(white scale = AC voltage
red scale = DC voltage)
- LED indication of polarity
- Double-pole voltage testing
- Type of protection IP 65
- Switching is not necessary
- 85 cm long highly flexible and nonskid test cable

The following can be detected by the WAGO Testboy:

- Live conductors
- Line breaks
- Blown fuses
- Defective switches
- Defective lamps

Wire Cutter and Stripping Tools, Series 206

Wire cutter acc. to VDE
for copper and aluminium wires
up to 35 mm²/AWG 2

Weight 200 g / 0.441 lbs



Quickstrip 10 wire stripper
0.02 mm² – 10 mm² "f-st" (6 mm² "s")
wire cutter up to 10 mm² "f-st" (1.5 mm² "s")

Weight 136 g / 0.297 lbs

Quickstrip 16 wire stripper
4 mm² – 16 mm²
wire cutter up to 10 mm² "f-st" (1.5 mm² "s")

Weight 136 g / 0.297 lbs



Item No.	Pack.-unit pcs	Item No.	Pack.-unit pcs	Item No.	Pack.-unit pcs
Wire cutter		Stripping tool Quickstrip 10		Stripping tool Quickstrip 16	
206-118	1	206-124	1	206-125	1
Accessories, Series 206					
		Standard blade cassette		Standard blade cassette	
		0.02 mm ² up to 10 mm ²		4 mm ² up to 16 mm ²	
		 206-126	1	 206-128	1
		"V" blade cassette			
		0.02 mm ² up to 4 mm ² for PTFE			
		 206-127	1		
Application notes					



Cutting of wire



Quickstrip 16. Stripping of wire.



Quickstrip 16. Cutting of wire.

- Automatic adjustment to wire size.
- No damage to wire strands.
- Gripping pressure of jaws adjusts automatically to wire insulation diameter
- Full cycle strip – jaws open after stripping, ensures no nicked strands.
- Exact strip length may be set by sliding of black setting stop.
- Replaceable stripping jaw assembly.
- Self-sharpening, fully protected wire cutter.
- Glass fiber reinforced polyamide tool body.

Crimping Tool Variocrimp 4, Variocrimp 16, Ferrules, Series 206, Series 216

<p>Crimping tools for ferrules insulated or uninsulated</p> <p>Variocrimp 4 from 0.25 mm² – 4 mm² Weight 400 g / 0.882 lbs Variocrimp 16 from 6 mm² – 16 mm² Weight 580 g / 1.28 lbs</p>	<p>Insulated ferrules</p>
--	----------------------------------



Item No.	Pack.-unit pcs	Sleeve for mm ² AWG	Color	Stripped length mm	L	L1	D mm	D1	D2	Item No.	Pack.-unit pcs
Variocrimp 4 206-204	1	0.25 24	yellow	7.5	10.5	6.0	2.5	2.0	0.8	216-321	1000
0.25 mm ² - 4 mm ² / AWG 24 - 12		0.25 24	yellow	9.5	12.5	8.0	2.5	2.0	0.8	216-301	1000
		0.35 24	green	7.5	10.5	6.0	2.5	2.0	0.8	216-322	1000
		0.34 24	green	9.5	12.5	8.0	2.5	2.0	0.8	216-302	1000
Variocrimp 16 206-216	1	0.5 22	white	7.5	11.5	6.0	3.0	2.5	1.1	216-221	1000
6 mm ² - 16 mm ² / AWG 10 - 6		0.5 22	white	9.5	13.5	8.0	3.0	2.5	1.1	216-201	1000
		0.75 20	grey	8.0	12.0	6.0	3.3	2.8	1.3	216-222	1000
		0.75 20	grey	10.0	14.0	8.0	3.3	2.8	1.3	216-202	1000
		1.0 18	red	8.0	12.0	6.0	3.6	3.0	1.5	216-223	1000
		1.0 18	red	10.0	14.0	8.0	3.6	3.0	1.5	216-203	1000
		1.5 16	black	8.0	12.0	6.0	4.0	3.4	1.8	216-224	1000
		1.5 16	black	10.0	14.0	8.0	4.0	3.4	1.8	216-204	1000
		2.08 14	yellow	10.0	14.5	8.0	4.2	3.6	2.05	216-205	1000
		2.5 14	blue	10.0	15.0	8.0	4.8	4.2	2.3	216-206	1000
		4.0 12	grey	12.0	16.8	9.5	5.4	4.8	2.9	216-207	1000
		6.0 10	yellow	14.0	20.0	12.0	6.8	6.2	3.5	216-208	100
		10.0 8	red	16.0	21.0	12.0	8.1	7.5	4.6	216-209	100
		16.0 6	blue	23.0	29.0	18.0	9.6	8.8	5.8	216-210	100

Application notes



Introduce conductor with ferrule into crimping station. Squeeze handles until ratchet mechanism is released.

- With the Variocrimp 4, the built-in crimping pressure control automatically adjusts the crimping force to the conductor cross section used. With the Variocrimp 16 it is necessary to select the wire gauge on the tool before crimping.
- Each tool has only one crimping station for all wire sizes handled.
- Uniform compact crimping from all four sides for high conductor retention.
- No necessity to centralize the conductor into the terminal ferrule.
- Conductor and ferrule insertion possible from both sides (for left- and right handers).
- Built-in ratchet to guarantee complete crimping every time.
- Tools open automatically after crimping operation is complete.
- Comfortable handles for operator.

Insulated ferrules, extra long, for TOBJOB®S terminal blocks											
0.5	22	white	12.0	16.0	10.0	3.1	2.6	1.0	216-241	1000	
0.75	20	grey	12.0	16.0	10.0	3.3	2.8	1.2	216-242	1000	
0.75	20	grey	14.0	18.0	12.0	3.3	2.8	1.2	216-262	1000	
1.0	18	red	12.0	16.0	10.0	3.5	3.0	1.4	216-243	1000	
1.0	18	red	14.0	18.0	12.0	3.5	3.0	1.4	216-263	1000	
1.5	16	black	12.0	16.0	10.0	4.0	3.5	1.7	216-244	1000	
1.5	16	black	14.0	18.0	12.0	4.0	3.5	1.7	216-264	1000	
1.5	16	black	20.0	24.0	18.0	4.0	3.5	1.7	216-284	1000	
2.5	14	blue	12.0	17.0	10.0	4.7	4.2	2.2	216-246	1000	
2.5	14	blue	14.0	19.0	12.0	4.7	4.2	2.2	216-266	1000	
2.5	14	blue	20.0	25.0	18.0	4.7	4.2	2.2	216-286	1000	
4.0	12	grey	14.0	20.0	12.0	5.4	4.8	2.8	216-267	500	
4.0	12	grey	20.0	26.0	18.0	5.4	4.8	2.8	216-287	500	
6.0	10	yellow	14.0	20.0	12.0	6.9	6.3	3.5	216-208	500	
6.0	10	yellow	20.0	26.0	18.0	6.9	6.3	3.5	216-288	500	
10.0	8	red	20.0	28.0	18.0	8.4	7.6	4.5	216-289	500	
16.0	6	blue	23.0	28.0	18.0	9.6	8.8	5.8	216-210	500	

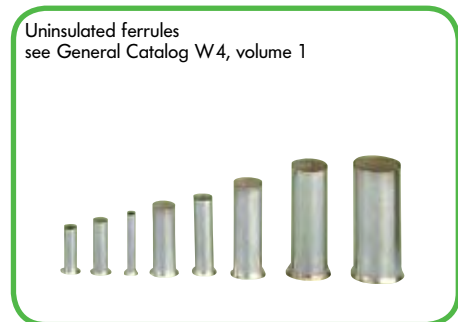
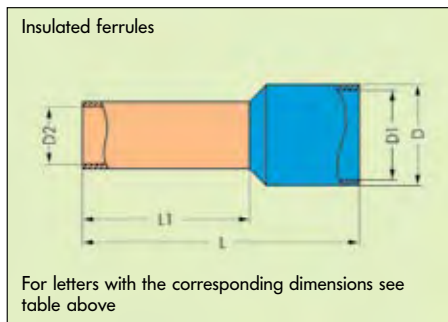

WAGO Service Worldwide

Germany

WAGO Kontakttechnik
Minden
Tel. ++0571/887-443
Fax ++0571/887-541

Austria

WAGO Kontakttechnik
GmgH Wien
Tel. ++43/1/615 07 80
Fax ++43/1/615 07 75

Belgium

WAGO Kontakttechnik
Zaventem
Tel. ++32/2/7 17 90 90
Fax ++32/2/7 17 90 99

China

WAGO ELECTRONIC Co. Ltd.
Tianjin
Tel. ++86/22/82125854/64/74
Fax ++86/22/82125984

England

WAGO, Ltd.
Rugby
Tel. ++44/1788/568008
Fax ++44/1788/568050

France

WAGO CONTACT SA.
Paris
Tel. ++33/148172590
Fax ++33/148632520

Italy

WAGO ELETTRONICA SRL
San Lazzaro di Savena (BO)
Tel. ++39/051/625-91-25
Fax ++39/051/625-91-27

Japan

WAGO Co. of JAPAN Ltd.
Tokyo
Tel. ++81/3/3254/8881
Fax ++81/3/3254/8885

Poland

WAGO ELWAG sp. z o. o.
Wroclaw
Tel. ++48/71/33-66-626
Fax ++48/71/33-60-952

Singapore

WAGO Electronic Pte. Ltd.
Singapur
Tel. ++65/2866776
Fax ++65/2842425

Switzerland

WAGO CONTACT SA
Domdidier
Tel. ++65/2866776
Fax ++65/2842425

Mexico

WAGO Corporation
Tel. 001-800-309-5975
+ 52-(55)-26-44-69-16
Fax + 52-(55)-26-44-69-15

Canada

WAGO Corporation
Tel. 800 / DIN Rail (346-7245)
Fax 262 / 255-3232

WAGO Corporation
N120 W19129 Freistadt Road
Germantown, Wisconsin 53022
Telephone: 800 / DIN Rail (346-7245)
Fax: 262 / 255-3232
info@wago.com
www.wago.us
www.wall-nuts.us

