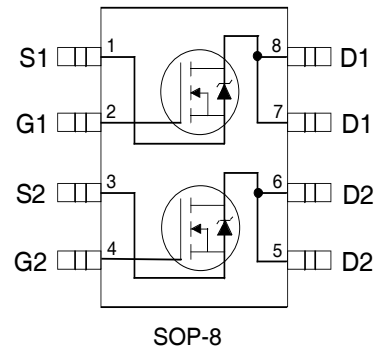


**Description**

The SOP-8 has been modified through a customized leadframe for enhanced thermal characteristics and multiple-die capability making it ideal in a variety of power applications. With these improvements, multiple devices can be used in an application with dramatically reduced board space. The package is designed for vapor phase, infra red, or wave soldering techniques. Power dissipation of greater than 0.8W is possible in a typical PCB mount application.

- Generation V Technology
- Ultra Low On-Resistance
- Dual N-Channel Mosfet
- Surface Mount
- Available in Tape & Reel
- Dynamic dv/dt Rating
- Fast Switching
- Lead-Free



**Features**

- $V_{DS} (V) = 20V$
- $R_{DS(ON)} < 40m\Omega$  ( $V_{GS} = 4.5V$ )
- $R_{DS(ON)} < 50m\Omega$  ( $V_{GS} = 2.7V$ )

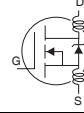
**Absolute Maximum Ratings**

	Parameter	Max.	Units
$I_D @ T_A = 25^\circ C$	10 Sec. Pulsed Drain Current, $V_{GS} @ 4.5V$	5.7	A
$I_D @ T_A = 25^\circ C$	Continuous Drain Current, $V_{GS} @ 4.5V$	5.2	A
$I_D @ T_A = 70^\circ C$	Continuous Drain Current, $V_{GS} @ 4.5V$	4.1	A
$I_{DM}$	Pulsed Drain Current ①	21	A
$P_D @ T_A = 25^\circ C$	Power Dissipation	2.0	W
	Linear Derating Factor	0.016	W/°C
$V_{GS}$	Gate-to-Source Voltage	$\pm 12$	V
dv/dt	Peak Diode Recovery dv/dt ②	5.0	V/ns
$T_J, T_{STG}$	Junction and Storage Temperature Range	-55 to + 150	°C

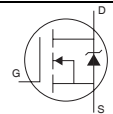
**Thermal Resistance Ratings**

	Parameter	Typ.	Max.	Units
$R_{\theta JA}$	Maximum Junction-to-Ambient③		62.5	°C/W

## Electrical Characteristics @ $T_J = 25^\circ\text{C}$ (unless otherwise specified)

	Parameter	Min.	Typ.	Max.	Units	Conditions
$V_{(BR)DSS}$	Drain-to-Source Breakdown Voltage	20			V	$V_{GS} = 0V, I_D = 250\mu A$
$\Delta V_{(BR)DSS}/\Delta T_J$	Breakdown Voltage Temp. Coefficient		0.044		V/ $^\circ\text{C}$	Reference to $25^\circ\text{C}, I_D = 1\text{mA}$
$R_{DS(ON)}$	Static Drain-to-Source On-Resistance			40 50	$m\Omega$	$V_{GS} = 4.5V, I_D = 2.6A$ ③ $V_{GS} = 2.7V, I_D = 2.2A$ ③
$V_{GS(th)}$	Gate Threshold Voltage	0.70			V	$V_{DS} = V_{GS}, I_D = 250\mu A$
$g_{fs}$	Forward Transconductance	8.3			S	$V_{DS} = 15V, I_D = 2.6A$
$I_{DSS}$	Drain-to-Source Leakage Current			1.0 25	$\mu A$	$V_{DS} = 16V, V_{GS} = 0V$ $V_{DS} = 16V, V_{GS} = 0V, T_J = 125^\circ\text{C}$
$I_{GSS}$	Gate-to-Source Forward Leakage			100	nA	$V_{GS} = 12V$
	Gate-to-Source Reverse Leakage			-100	nA	$V_{GS} = -12V$
$Q_g$	Total Gate Charge			20	nC	$I_D = 2.6A$
$Q_{gs}$	Gate-to-Source Charge			2.2	nC	$V_{DS} = 16V$
$Q_{gd}$	Gate-to-Drain ("Miller") Charge			8.0	nC	$V_{GS} = 4.5V$ , See Fig. 6 and 12 ③
$t_{d(on)}$	Turn-On Delay Time		9.0		ns	$V_{DD} = 10V$ $I_D = 2.6A$ $R_G = 6.0\Omega$ $R_D = 3.8\Omega$ , See Fig. 10 ③
$t_r$	Rise Time		42			
$t_{d(off)}$	Turn-Off Delay Time		32			
$t_f$	Fall Time		51			
$L_D$	Internal Drain Inductance		4.0		nH	Between lead tip and center of die contact 
$L_S$	Internal Source Inductance		6.0			
$C_{iss}$	Input Capacitance		660		pF	$V_{GS} = 0V$ $V_{DS} = 15V$ $f = 1.0\text{MHz}$ , See Fig. 5
$C_{oss}$	Output Capacitance		280			
$C_{riss}$	Reverse Transfer Capacitance		140			

## Source-Drain Ratings and Characteristics

	Parameter	Min.	Typ.	Max.	Units	Conditions
$I_S$	Continuous Source Current (Body Diode)			2.5	A	MOSFET symbol showing the integral reverse p-n junction diode. 
$I_{SM}$	Pulsed Source Current (Body Diode) ①			21		
$V_{SD}$	Diode Forward Voltage			1.0	V	$T_J = 25^\circ\text{C}, I_S = 1.8A, V_{GS} = 0V$ ③
$t_{rr}$	Reverse Recovery Time		29	44	ns	$T_J = 25^\circ\text{C}, I_F = 2.6A$
$Q_{rr}$	Reverse Recovery Charge		22	33	nC	$di/dt = 100A/\mu s$ ③
$t_{on}$	Forward Turn-On Time	Intrinsic turn-on time is negligible (turn-on is dominated by $L_S+L_D$ )				

### Notes:

- ① Repetitive rating; pulse width limited by max. junction temperature. ( See fig. 11 )
- ②  $I_{SD} \leq 2.6A, di/dt \leq 100A/\mu s, V_{DD} \leq V_{(BR)DSS}, T_J \leq 150^\circ\text{C}$
- ③ Pulse width  $\leq 300\mu s$ ; duty cycle  $\leq 2\%$ .
- ④ Surface mounted on FR-4 board,  $t \leq 10\text{sec}$ .

TYPICAL CHARACTERISTICS (25 °C, unless otherwise noted)

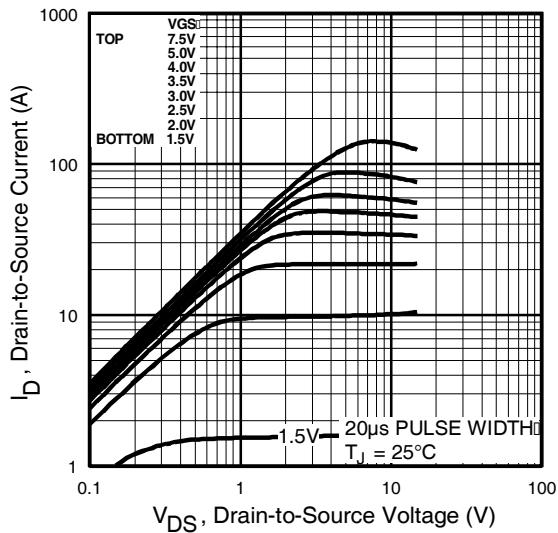


Fig 1. Typical Output Characteristics

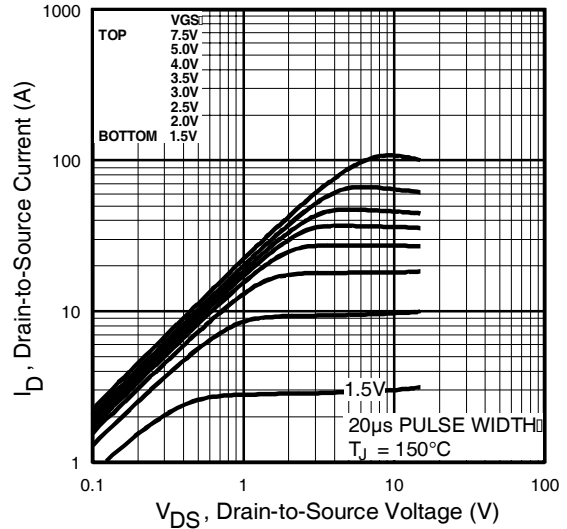


Fig 2. Typical Output Characteristics

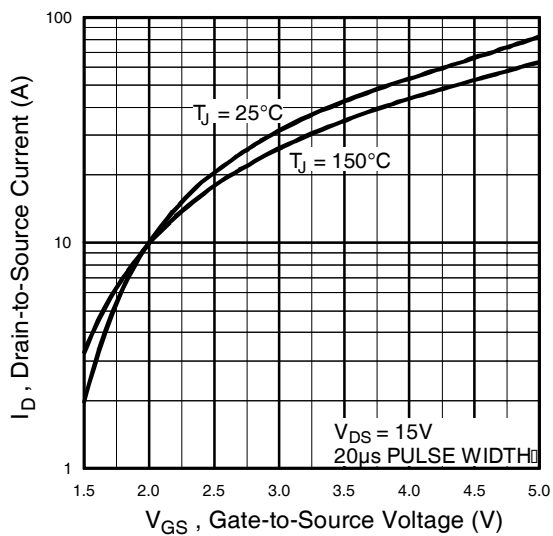


Fig 3. Typical Transfer Characteristics

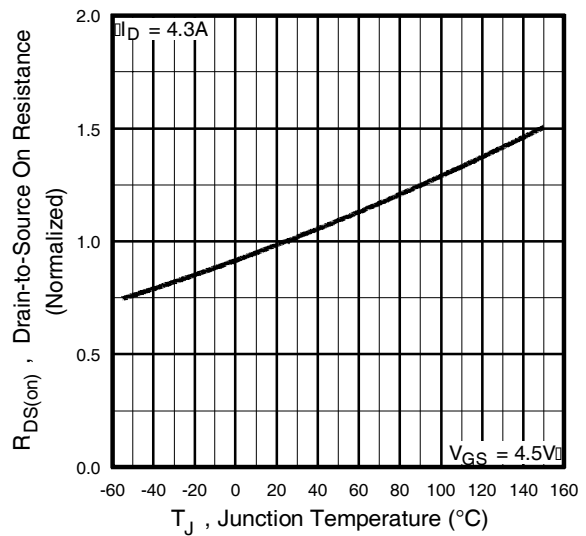


Fig 4. Normalized On-Resistance Vs. Temperature

TYPICAL CHARACTERISTICS (25 °C, unless otherwise noted)

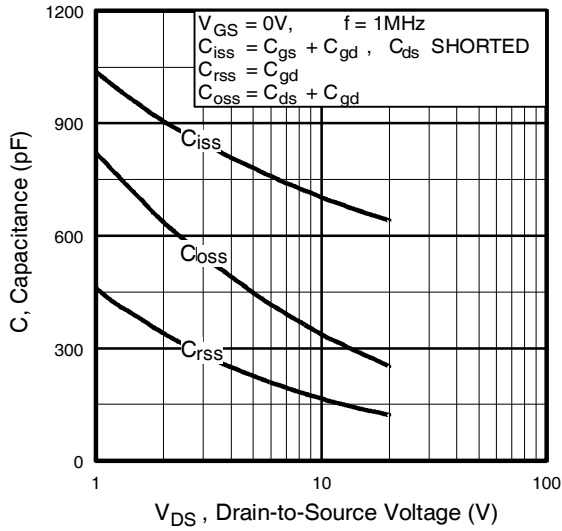


Fig 5. Typical Capacitance Vs. Drain-to-Source Voltage

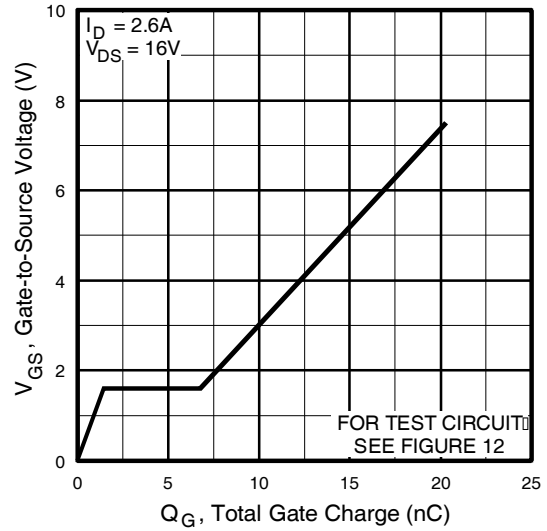


Fig 6. Typical Gate Charge Vs. Gate-to-Source Voltage

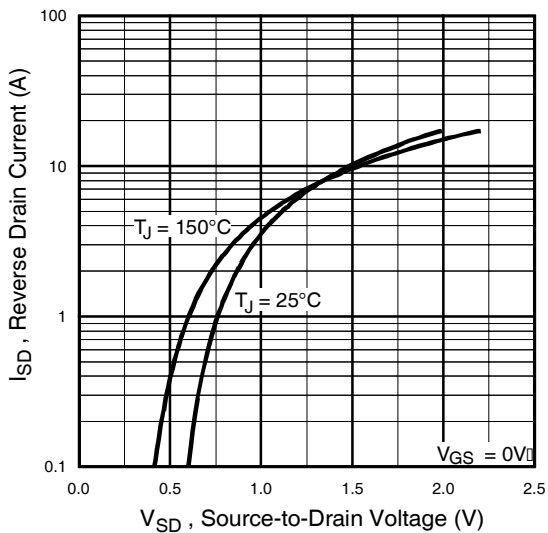


Fig 7. Typical Source-Drain Diode Forward Voltage

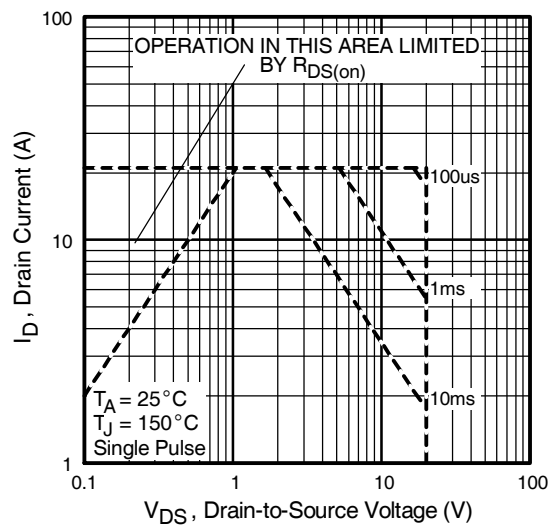
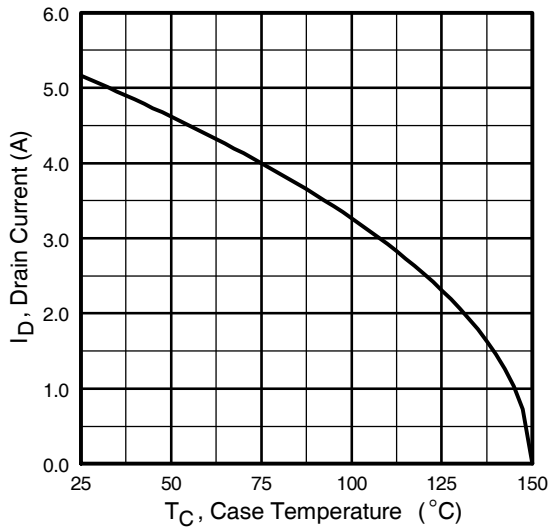
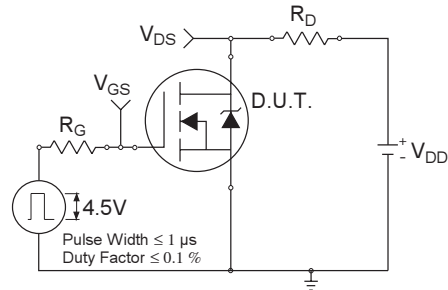


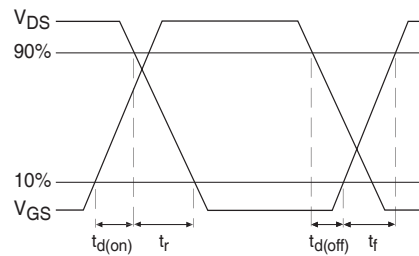
Fig 8. Maximum Safe Operating Area



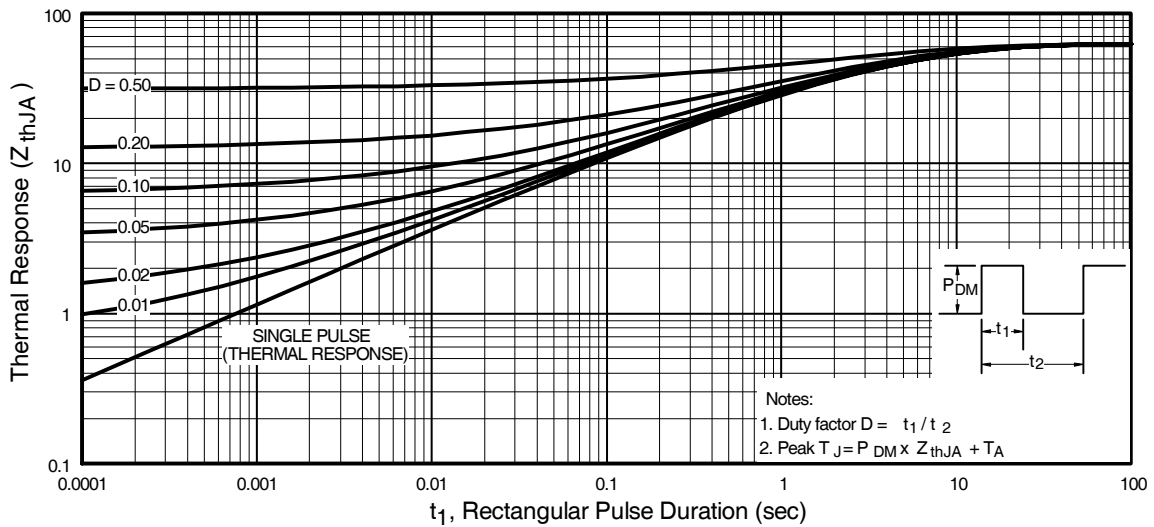
**Fig 9.** Maximum Drain Current Vs. Ambient Temperature



**Fig 10a.** Switching Time Test Circuit

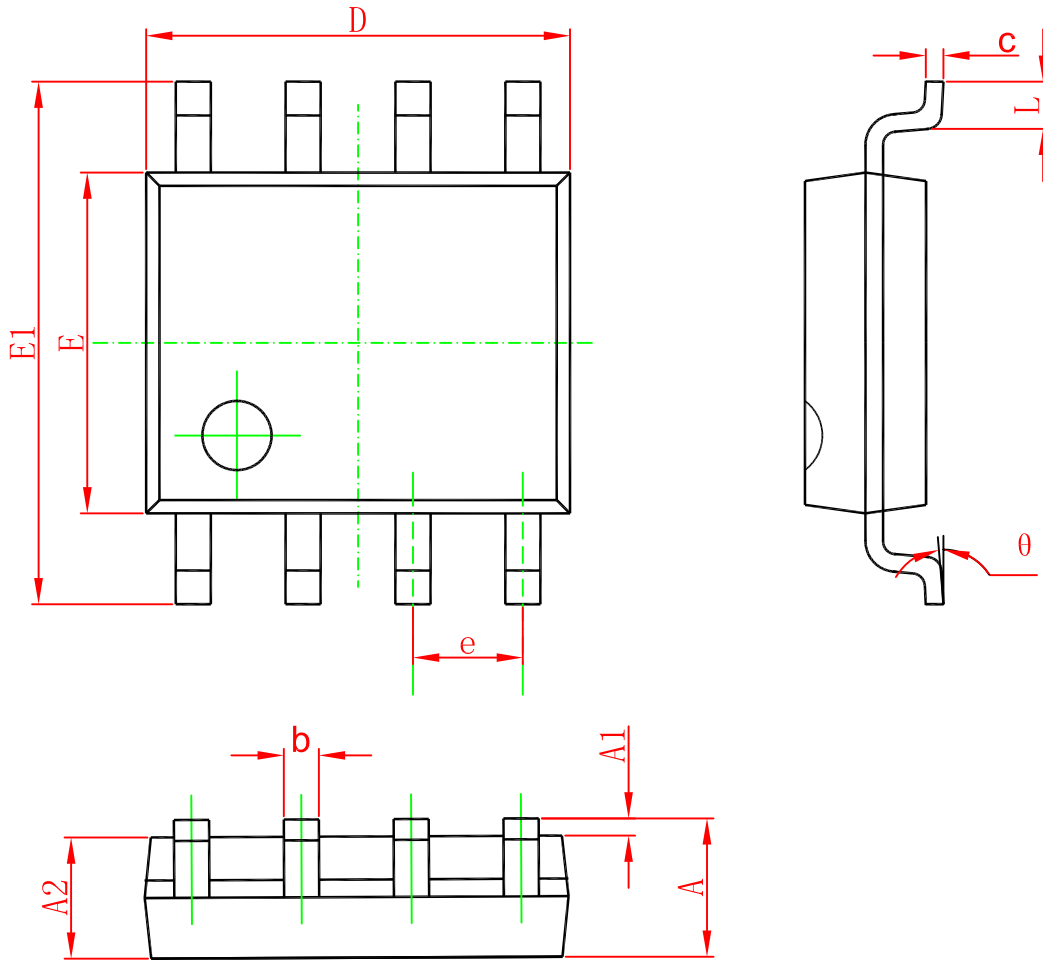


**Fig 10b.** Switching Time Waveforms



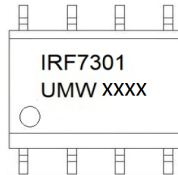
**Fig 11.** Maximum Effective Transient Thermal Impedance, Junction-to-Ambient

SOP-8



Symbol	Dimensions In Millimeters		Dimensions In Inches	
	Min	Max	Min	Max
A	1.350	1.750	0.053	0.069
A1	0.100	0.250	0.004	0.010
A2	1.350	1.550	0.053	0.061
b	0.330	0.510	0.013	0.020
c	0.170	0.250	0.006	0.010
D	4.700	5.100	0.185	0.200
E	3.800	4.000	0.150	0.157
E1	5.800	6.200	0.228	0.244
e	1.270(BSC)		0.050(BSC)	
L	0.400	1.270	0.016	0.050
θ	0°	8°	0°	8°

### Marking



### Ordering information

Order code	Package	Baseqty	Deliverymode
UMW IRF7301TR	SOP-8	3000	Tape and reel