



FEATURES

- Patent protected
- UL 60950 recognised
- Footprint over pins 0.69cm²
- Single & dual isolated outputs
- 1kVDC isolation “Hi Pot Test”
- Efficiency up to 85% (Typ.)
- MSL level 1
- Power density 3.403W/cm³
- 3.3V & 5V inputs
- 5V & 24V outputs
- Custom solutions available
- Multi-layer ceramic capacitors

PRODUCT OVERVIEW

The MTU2 series is a new range of miniature surface mount, high performance 2W DC-DC converters. With a footprint reduction of over 50% from the previous generations of 2W SMD DC-DC, the MTU2 series offers 2W of available output power over a wide temperature range. The MTU2 series is more efficient and offers improved regulation performance for applications where a wide output voltage variation can not be tolerated. The MTU2 series is pin compatible with the MTU2 series.

The devices are suitable for all applications where high volume production is envisaged.

SELECTION GUIDE

Order Code ¹	Nominal Input Voltage	Output Voltage	Output Current	Load Regulation (Typ.)	Load Regulation (Max)	Ripple & Noise (Typ.) ³	Ripple & Noise (Max.) ³	Input Current at Full Load	Efficiency (Min.)	Efficiency (Typ.)	Isolation Capacitance	MTTF ²	Recommended Alternative
	V	V	mA	%	%	mVp-p	mVp-p	mA	%	%	pF	kHrs	
	Recommended In Production												
MTU2S0305MC	3.3	5	400	12.5	15	53	75	740	74	79	15	2650	
MTU2S0505MC	5	5	400	9.5	12	47	65	480	78	82	17	2763	
MTU2S0524MC	5	24	83	9	11	14	30	460	79	85	18	3060	
	Discontinued												
MTU2D0505MC	5	±5	±200	10.5	13	30	55	480	77	82	19	2898	NXE2S0505MC-R7
MTU2D0512MC	5	±12	±83	8.5	11	15	35	460	79	85	19	2697	NMH0512SC
MTU2S1205MC	12	5	400	7.5	10	40	60	200	72	80	20	2207	NXE2S1205MC-R7
MTU2D1212MC	12	±12	±83	6.5	8	15	35	190	77	83	24	2452	NXE2S1212MC-R7
MTU2S2405MC	24	5	400	8	10	30	50	100	73	80	21	2314	NXJ2S2405MC-R7

INPUT CHARACTERISTICS

Parameter	Conditions	Min.	Typ.	Max.	Units
Voltage range	Continuous operation, 3.3V input types	2.97	3.3	3.63	V
	Continuous operation, 5V input types	4.5	5.0	5.5	
	Continuous operation, 12V input types	10.8	12.0	13.2	
	Continuous operation, 24V input types	21.6	24	26.4	
Reflected ripple current	All variants		10		mA p-p

GENERAL CHARACTERISTICS

Parameter	Conditions	Min.	Typ.	Max.	Units
Switching frequency	MTU2D0505MC		50		kHz
	All other variants		70		

OUTPUT CHARACTERISTICS

Parameter	Conditions	Min.	Typ.	Max.	Units
Rated power	T _A =-40°C to 85°C			2.0	W
Voltage set point accuracy	See tolerance envelope				
Line regulation	High V _{IN} to low V _{IN}	MTU2S0305MC	1.0	1.3	%/%
		All other variants	1.0	1.2	

ISOLATION CHARACTERISTICS

Parameter	Conditions	Min.	Typ.	Max.	Units
Isolation voltage	Flash tested for 1 minute	1000			VDC
Resistance	Viso= 1000VDC	10			GΩ



1. If components are required in tape and reel format suffix order code with -R, e.g. MTU20505MC-R.
 2. Calculated using MIL-HDBK-217 FN2 calculation model with nominal input voltage at full load.
 3. See ripple & noise characterisation method.
- All specifications typical at T_A=25°C, nominal input voltage and rated output current unless otherwise specified.

TEMPERATURE CHARACTERISTICS					
Parameter	Conditions	Min.	Typ.	Max.	Units
Specification	All output types (see safety approval section for limitations)	-40		85	°C
Storage		-50		125	
Case temperature rise above ambient ¹	0305, 1205, 2405		30	45	
	All other variants		25	35	
Cooling	Free air convection				

ABSOLUTE MAXIMUM RATINGS	
Input voltage V_{IN} , MTU2S03 types	5.5V
Input voltage V_{IN} , MTU2S05 types	7V
Input voltage V_{IN} , MTU2S12 types	15V
Input voltage V_{IN} , MTU2S24 types	28V

1 . Measured after 1 hour continuous operation at nominal V_{IN} full load at the center of each PCB.

TECHNICAL NOTES

ISOLATION VOLTAGE

'Hi Pot Test', 'Flash Tested', 'Withstand Voltage', 'Proof Voltage', 'Dielectric Withstand Voltage' & 'Isolation Test Voltage' are all terms that relate to the same thing, a test voltage, applied for a specified time, across a component designed to provide electrical isolation, to verify the integrity of that isolation.

Murata Power Solutions MTU2 series of DC-DC converters are all 100% production tested at their stated isolation voltage. This is 1kVDC for 1 second.

A question commonly asked is, "What is the continuous voltage that can be applied across the part in normal operation?"

The MTU2 has been recognised by Underwriters Laboratory for functional insulation, both input and output should normally be maintained within SELV limits i.e. less than 42.4V peak, or 60VDC. The isolation test voltage represents a measure of immunity to transient voltages and the part should never be used as an element of a safety isolation system. The part could be expected to function correctly with several hundred volts offset applied continuously across the isolation barrier; but then the circuitry on both sides of the barrier must be regarded as operating at an unsafe voltage and further isolation/insulation systems must form a barrier between these circuits and any user-accessible circuitry according to safety standard requirements.

REPEATED HIGH-VOLTAGE ISOLATION TESTING

It is well known that repeated high-voltage isolation testing of a barrier component can actually degrade isolation capability, to a lesser or greater degree depending on materials, construction and environment. The MTU2 series has toroidal isolation transformers, with no additional insulation between primary and secondary windings of enamelled wire. While parts can be expected to withstand several times the stated test voltage, the isolation capability does depend on the wire insulation. Any material, including this enamel (typically polyurethane) is susceptible to eventual chemical degradation when subject to very high applied voltages thus implying that the number of tests should be strictly limited. We therefore strongly advise against repeated high voltage isolation testing, but if it is absolutely required, that the voltage be reduced by 20% from specified test voltage. This consideration equally applies to agency recognised parts rated for better than functional isolation where the wire enamel insulation is always supplemented by a further insulation system of physical spacing or barriers.

SAFETY APPROVAL

The MTU2 series has been recognised by Underwriters Laboratory (UL) to UL 60950 for functional insulation to a maximum product PCB temperature of 120°C. Forced air cooling may be used to maintain this temperature requirement. File number E151252 applies.

The MTU2 Series of converters are not internally fused so to meet the requirements of UL 60950 an anti-surge input line fuse should always be used with ratings as defined below.

- MTU2S03xxxC: 1.5A
- MTU2S05xxxC: 0.63A
- MTU2S12xxxC: 0.3A
- MTU2S24xxxC: 0.25A

All fuses should be UL approved and rated to at least the maximum allowable DC input voltage.

RoHS COMPLIANCE INFORMATION



This series is compatible with RoHS soldering systems with a peak reflow solder temperature of 245°C as per J-STD-020D.1. Please refer to [application notes](#) for further information. The pin termination finish on this product series is Matte Tin over Nickel Preplate. The series is backward compatible with Sn/Pb soldering systems. The series has a Moisture Sensitivity Level (MSL) 1. Samples of the product series were tested in accordance with the conditioning described for MSL level 1 in IPS/J-STD-020D.1. The product series passed electrical tests and visual inspection criteria. For further information, please visit: www.murata.com/en-global/products/power/rohs

PART NUMBER STRUCTURE

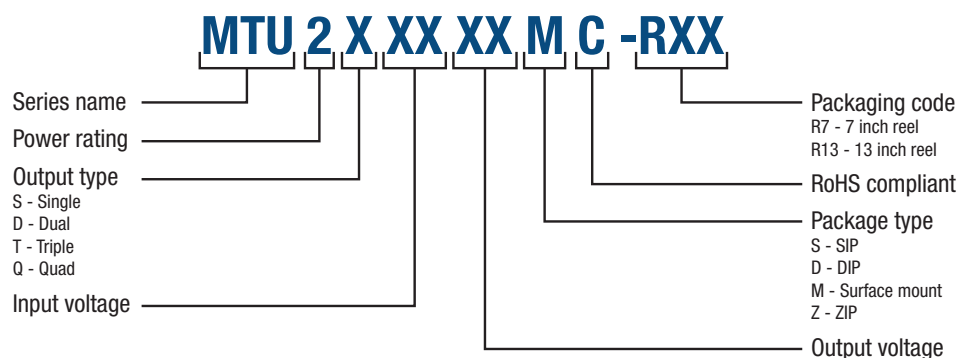

CHARACTERISATION TEST METHODS

Ripple & Noise Characterisation Method

Ripple and noise measurements are performed with the following test configuration.

C1	1µF X7R multilayer ceramic capacitor, voltage rating to be a minimum of 3 times the output voltage of the DC-DC converter
C2	10µF tantalum capacitor, voltage rating to be a minimum of 1.5 times the output voltage of the DC-DC converter with an ESR of less than 100mΩ at 100 kHz
C3	100nF multilayer ceramic capacitor, general purpose
R1	450Ω resistor, carbon film, ±1% tolerance
R2	50Ω BNC termination
T1	3T of the coax cable through a ferrite toroid
RLOAD	Resistive load to the maximum power rating of the DC-DC converter. Connections should be made via twisted wires

Measured values are multiplied by 10 to obtain the specified values.

Differential Mode Noise Test Schematic

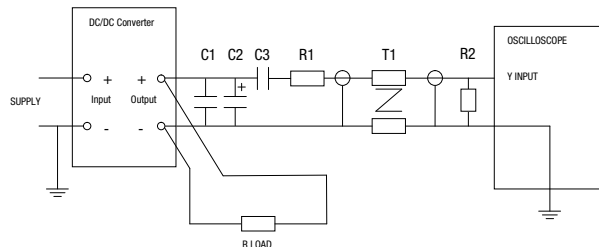

APPLICATION NOTES

Minimum load

The minimum load to meet datasheet specification is 10% of the full rated load across the specified input voltage range. Lower than 10% minimum loading will result in an increase in output voltage, which may rise to typically double the specified output voltage if the output load falls to less than 5%.

Capacitive loading and start up

Typical start up times for this series, with a typical input voltage rise time of 2.2µs and output capacitance of 10µF, are shown in the table below. The product series will start into a capacitance of 47µF with an increased start time, however, the maximum recommended output capacitance is 10µF.

	Start-up time µs
MTU2S0305MC	225
MTU2S0505MC	165
MTU2S0524MC	3900
MTU2S1205MC	90
MTU2S2405MC	90
MTU2D0505MC	200
MTU2D0512MC	880
MTU2D1212MC	390

Typical Start-Up Wave Form

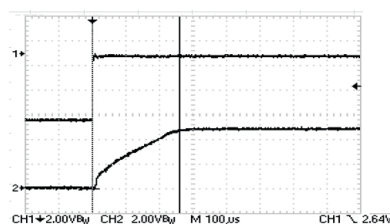

APPLICATION NOTES (Continued)

Output Ripple Reduction

By using the values of inductance and capacitance stated, the output ripple at the rated load is lowered to 5mV p-p max.

Component selection

Capacitor: It is required that the ESR (Equivalent Series Resistance) should be as low as possible, ceramic types are recommended. The voltage rating should be at least twice (except for 15V output), the rated output voltage of the DC-DC converter.

Inductor: The rated current of the inductor should not be less than that of the output of the DC-DC converter. At the rated current, the DC resistance of the inductor should be such that the voltage drop across the inductor is <2% of the rated voltage of the DC-DC converter. The SRF (Self Resonant Frequency) should be >20MHz.

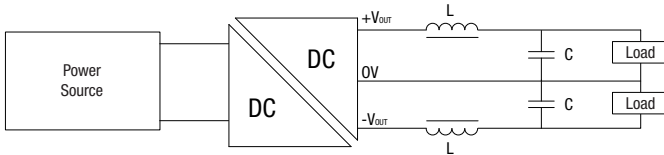

	Inductor			Capacitor
	L, μ H	SMD	Through Hole	C, μ F
MTU2S0305MC	4.7	82472C	11R472C	22
MTU2S0505MC	4.7	82472C	11R472C	22
MTU2S0524MC	47	82473C	11R473C	4.7
MTU2S1205MC	4.7	82472C	11R472C	22
MTU2S2405MC	4.7	82472C	11R472C	10
MTU2D0505MC	4.7	82472C	11R472C	22
MTU2D0512MC	47	82473C	11R473C	4.7
MTU2D1212MC	47	82473C	11R473C	4.7

TOLERANCE ENVELOPES

The voltage tolerance envelopes show typical load regulation characteristics for this product series. The tolerance envelope is the maximum output voltage variation due to changes in output loading and set point accuracy.

MTU2D1212MC, MTU2S2405MC & MTU2D0512MC

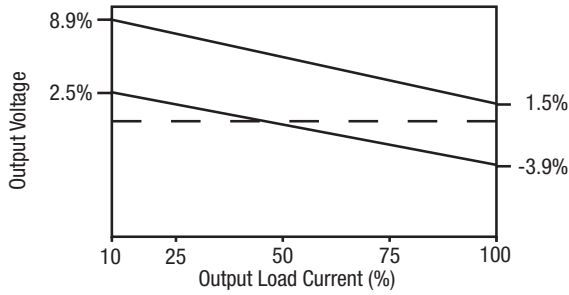

MTU2D0505MC, MTU2S0505MC & MTU2S1205MC

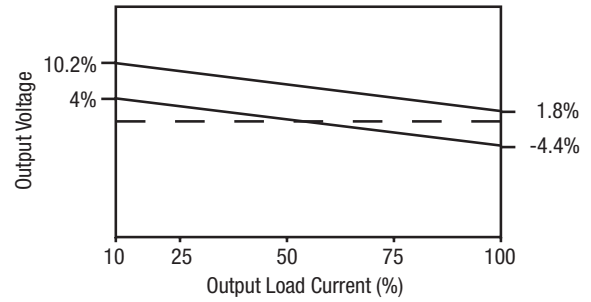

MTU2S0305MC

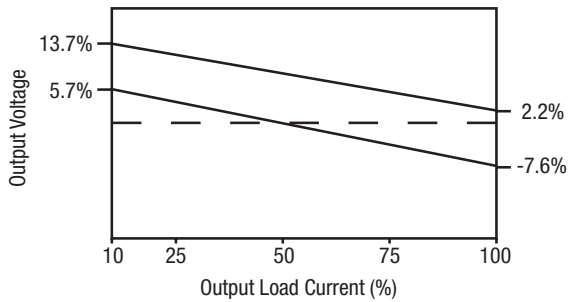

MTU2S0524MC

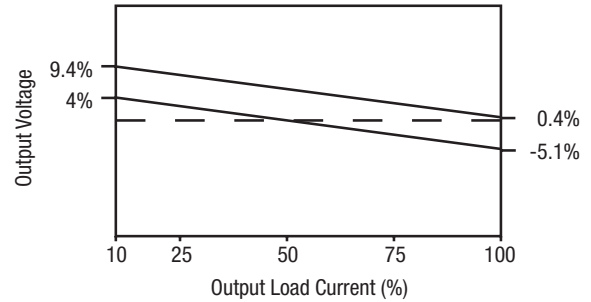

EFFICIENCY VS LOAD

3.3V INPUT

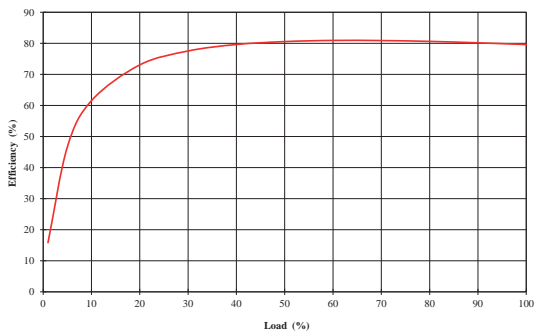

5V INPUT

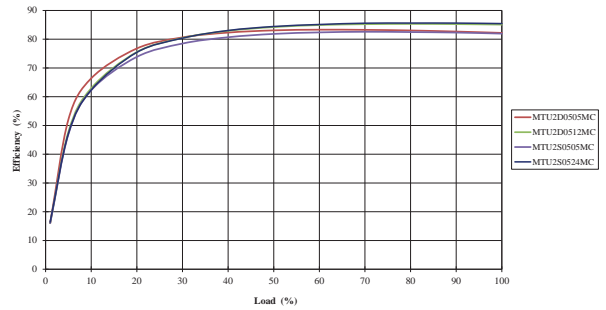

12V INPUT

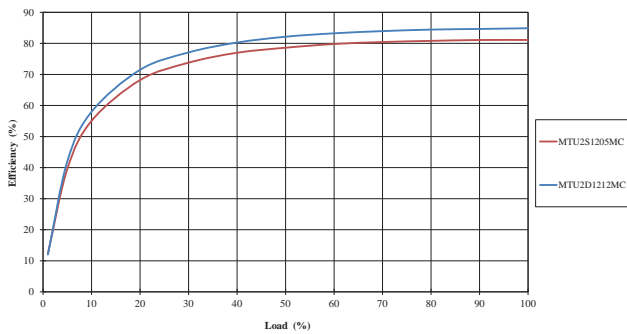

24V INPUT

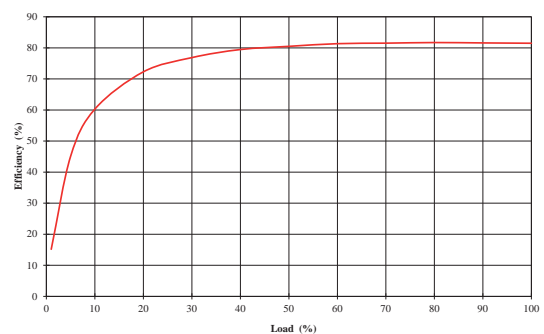

TEMPERATURE DERATING

MTU2S0305MC

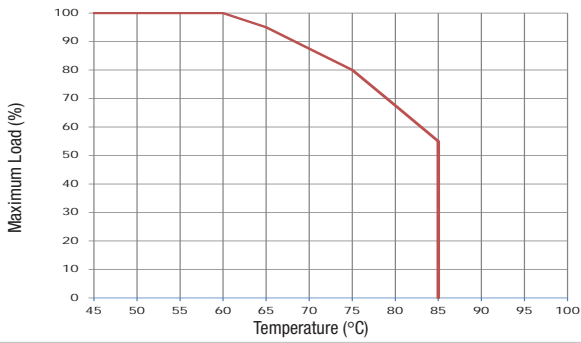

MTU2S0505MC

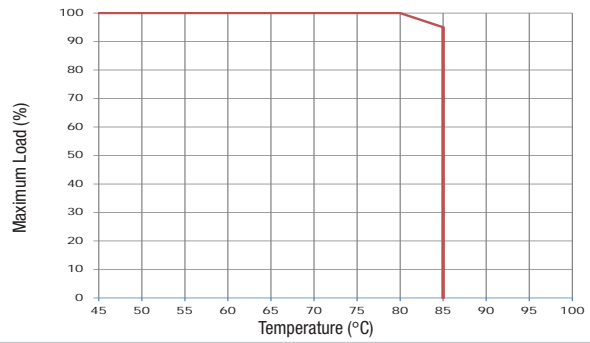

MTU2S0524MC

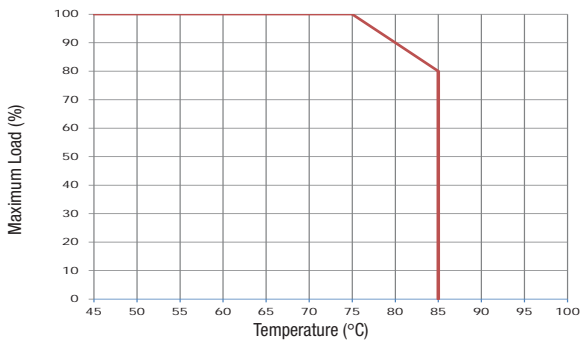

MTU2S1205MC

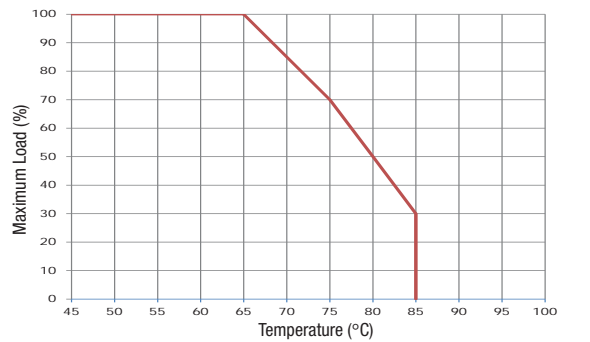

MTU2S2405MC

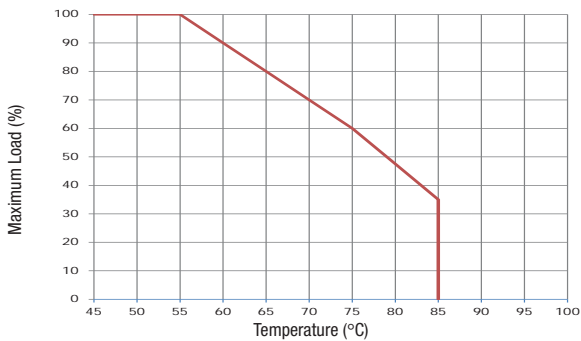

MTU2D0505MC

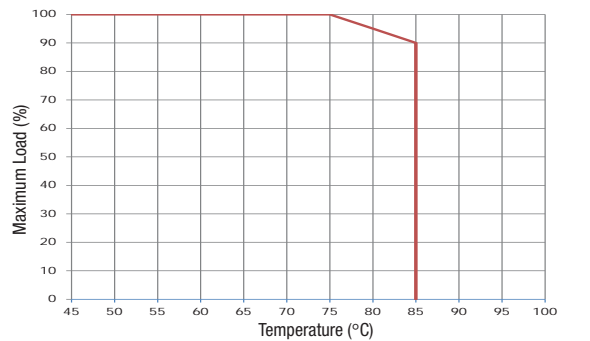

MTU2D0512MC

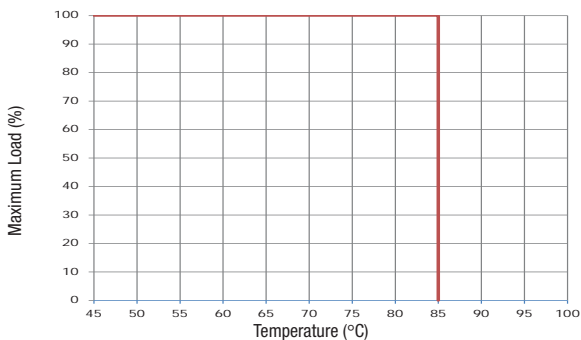

MTU2D1212MC

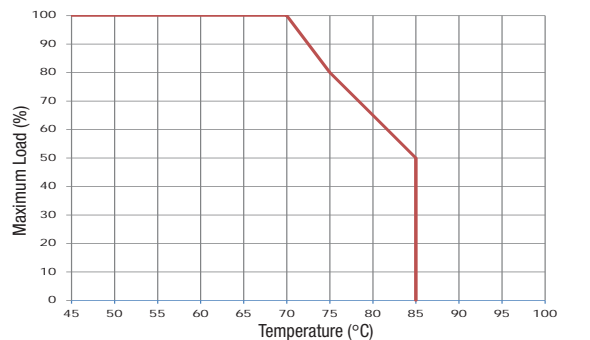

PACKAGE SPECIFICATIONS

MECHANICAL DIMENSIONS

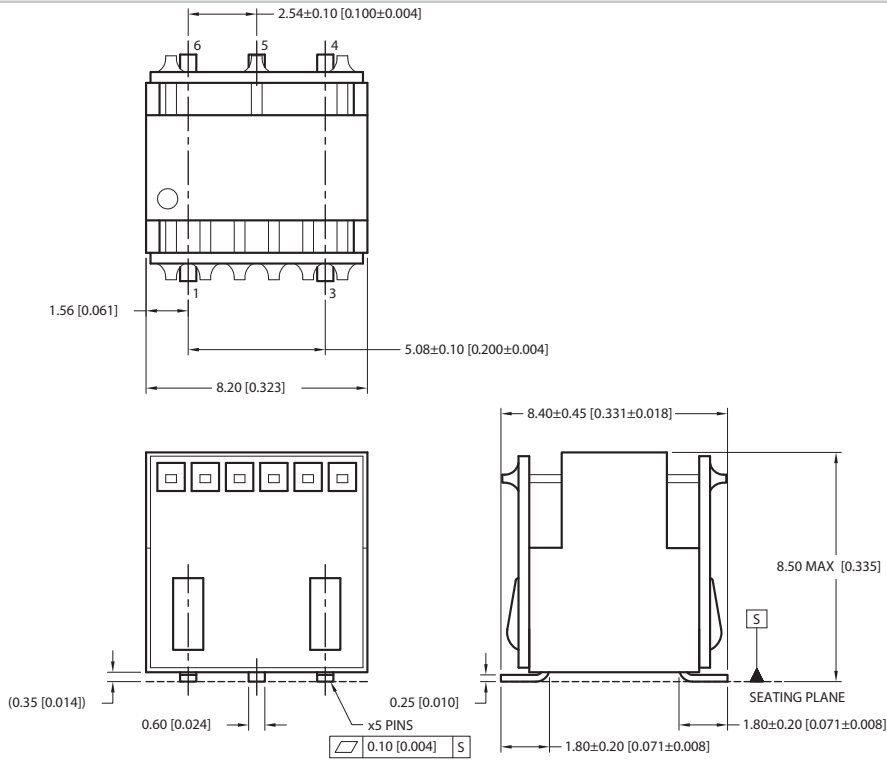

All dimensions in mm (inches) ± 0.05mm (0.002"). Controlling dimension is mm. All pins on a 2.54mm (0.100") pitch. Weight: 0.79g, typ.

PIN CONNECTIONS

Single Output Types	
Pin	Function
1	+V _{IN}
3	-V _{IN}
4	NC
5	OV
6	+V _{OUT}

Dual Output Types	
Pin	Function
1	+V _{IN}
3	-V _{IN}
4	-V _{OUT}
5	OV
6	+V _{OUT}

RECOMMENDED FOOTPRINT DETAILS

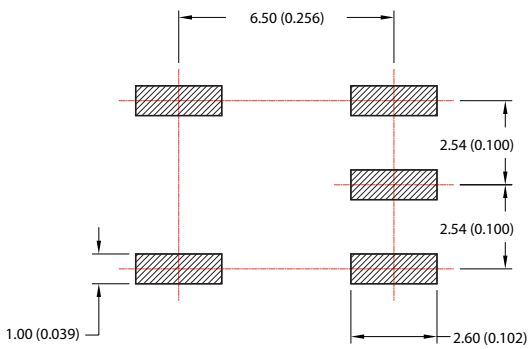

TUBE OUTLINE DIMENSIONS

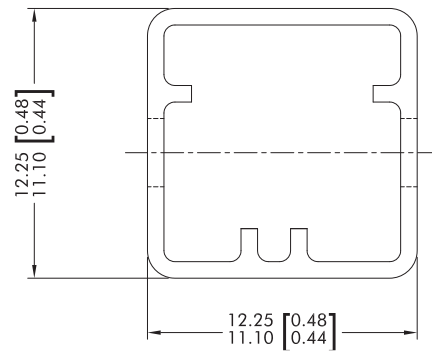

Unless otherwise stated all dimensions in mm (inches).
Tube length: 520mm (20.472) ± 2.00 (0.079).

Tube Quantity: 60

TAPE & REEL SPECIFICATIONS

REEL OUTLINE DIMENSIONS

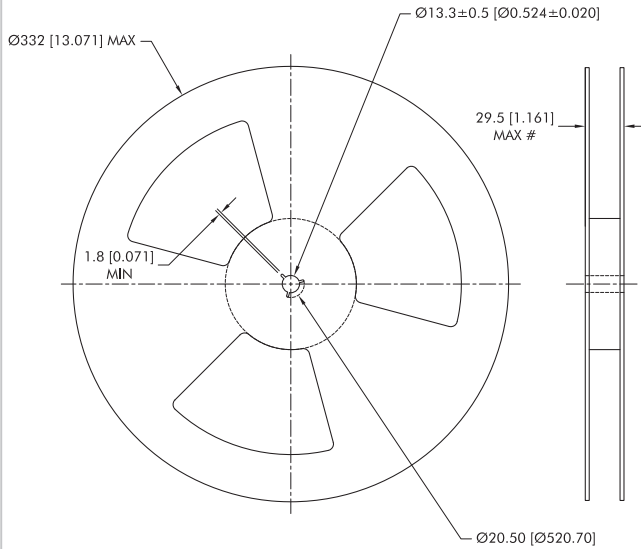

REEL PACKAGING DETAILS

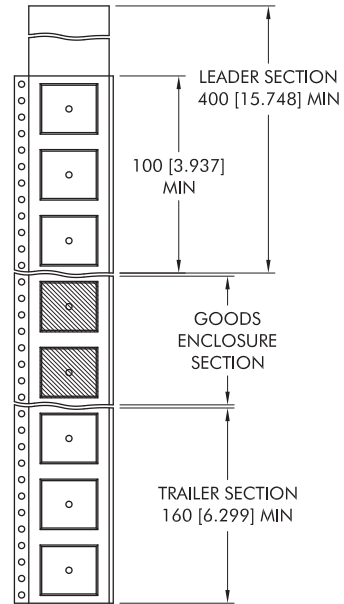

TAPE OUTLINE DIMENSIONS

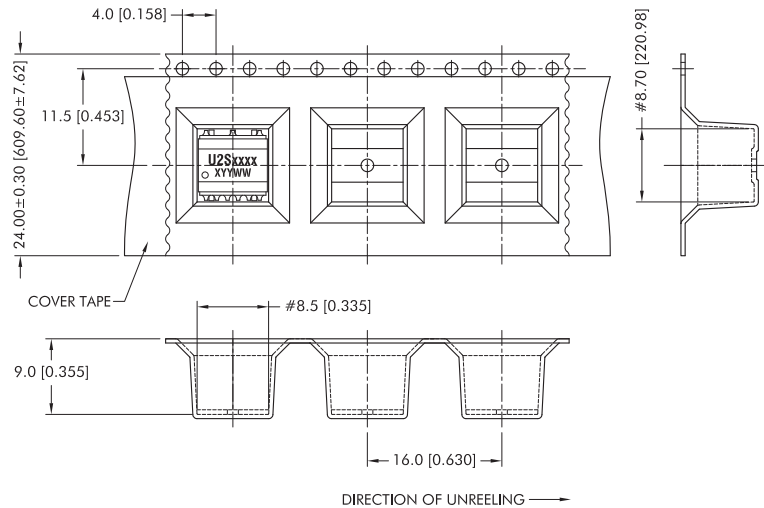

Unless otherwise stated all dimensions in mm (inches).
Controlling dimension is mm.
Components shall be orientated within the carrier tape as indicated.

Reel Quantity: 400 pcs.

DISCLAIMER

Unless otherwise stated in the datasheet, all products are designed for standard commercial and industrial applications and NOT for safety-critical and/or life-critical applications.

Particularly for safety-critical and/or life-critical applications, i.e. applications that may directly endanger or cause the loss of life, inflict bodily harm and/or loss or severe damage to equipment/property, and severely harm the environment, a prior explicit written approval from Murata is strictly required. Any use of Murata standard products for any safety-critical, life-critical or any related applications without any prior explicit written approval from Murata shall be deemed unauthorised use.

These applications include but are not limited to:

- Aircraft equipment
- Aerospace equipment
- Undersea equipment
- Power plant control equipment
- Medical equipment
- Transportation equipment (automobiles, trains, ships, etc.)
- Traffic signal equipment
- Disaster prevention / crime prevention equipment
- Data Processing equipment

Murata makes no express or implied warranty, representation, or guarantee of suitability, fitness for any particular use/purpose and/or compatibility with any application or device of the buyer, nor does Murata assume any liability whatsoever arising out of unauthorised use of any Murata product for the application of the buyer. The suitability, fitness for any particular use/purpose and/or compatibility of Murata product with any application or device of the buyer remain to be the responsibility and liability of the buyer.

Buyer represents and agrees that it has all the necessary expertise to create and implement safeguards that anticipate dangerous consequences of failures, monitor failures and their consequences, lessen the likelihood of failures that might cause harm, and take appropriate remedial actions. Buyer will fully indemnify and hold Murata, its affiliated companies, and its representatives harmless against any damages arising out of unauthorised use of any Murata products in any safety-critical and/or life-critical applications.

Remark: Murata in this section refers to Murata Manufacturing Company and its affiliated companies worldwide including, but not limited to, Murata Power Solutions.



This product is subject to the following [operating requirements](https://www.murata.com/en-eu/products/power/requirements) and the [Life and Safety Critical Application Sales Policy](https://www.murata.com/en-eu/products/power/requirements):

Refer to: <https://www.murata.com/en-eu/products/power/requirements>

Murata Power Solutions (Milton Keynes) Ltd. makes no representation that the use of its products in the circuits described herein, or the use of other technical information contained herein, will not infringe upon existing or future patent rights. The descriptions contained herein do not imply the granting of licenses to make, use, or sell equipment constructed in accordance therewith. Specifications are subject to change without notice.

© 2023 Murata Power Solutions (Milton Keynes) Ltd.