

THIS DOCUMENT IS THE PROPERTY OF
KEYSTONE ELECTRONICS CORP. AND
SHALL NOT BE REPRODUCED, DISTRIBUTED
OR USED AS A BASIS FOR MANUFACTURE
WITHOUT PRIOR WRITTEN PERMISSION
FROM KEYSTONE ELECTRONICS CORP.

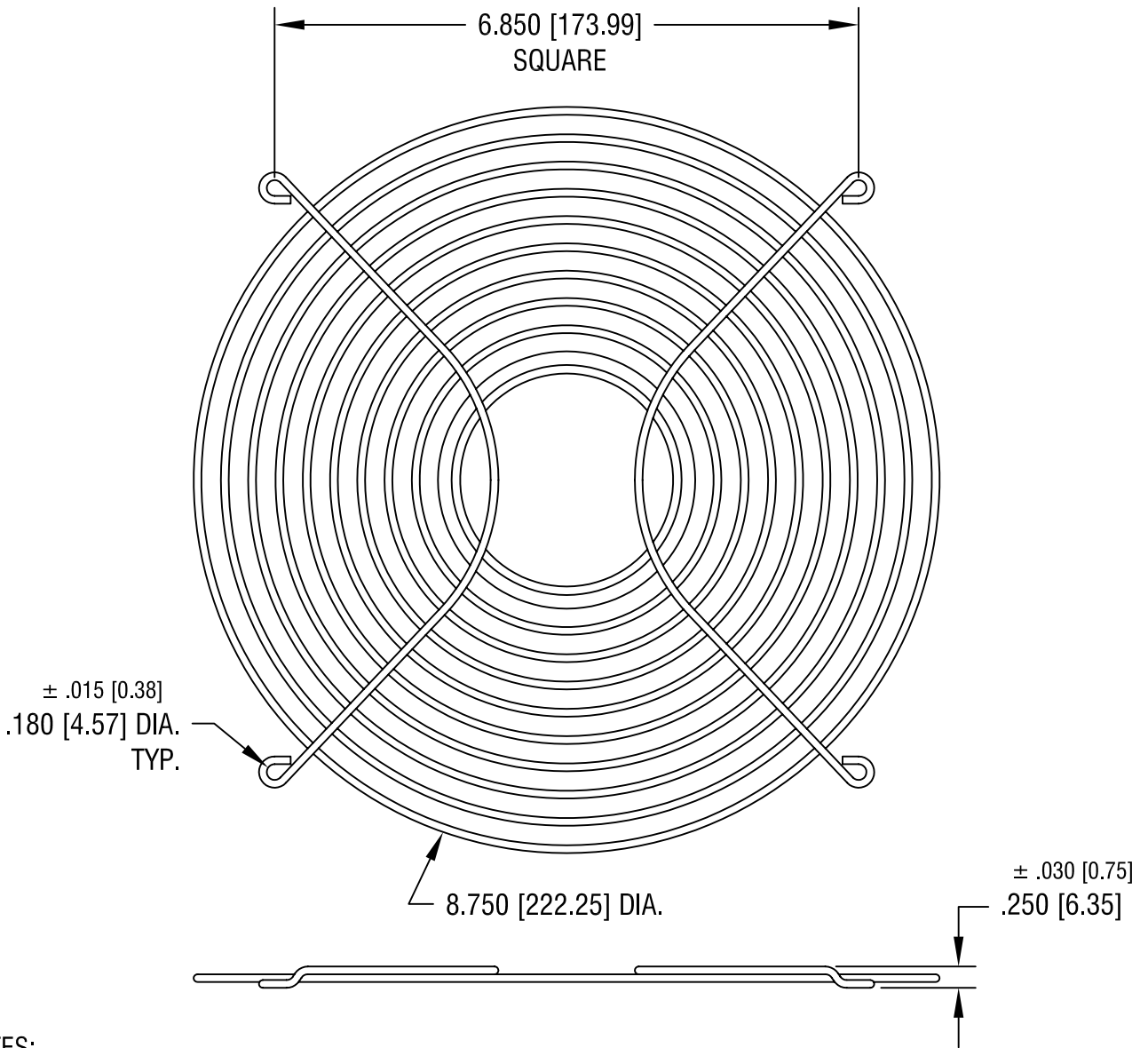

NOTES:

1. RINGS: .091 [2.31] DIA.
RIBS: .091 [2.31] DIA.
2. FINISH - NICKEL CHROME PLATE

KEYSTONE ELECTRONICS CORP.

ASTORIA, N.Y. 11105-2017

PART NAME

FAN/FINGER GUARD (254MM)

MATERIAL

STEEL

FINISH

AS NOTED

DRN BY

BOONE

DATE

3.7.06

APP'D

LN

SCALE

.5X

TOLERANCES

INCH

[MM]

DECIMAL ± .020 [± 0.50]

ANGULAR ± 1°

UNLESS OTHERWISE SPECIFIED

CODE

C/M

DWG NO.

8457

DATE

DESCRIPTION

REV.