

Part No. 1004369PT

Wi-Fi Mixed Polarized Tunable PCB 5 GHz Embedded Antenna

5 GHz

Supports: Wi-Fi applications, Agriculture, Automotive, Bluetooth, Zigbee, WLAN, Smart Home, Healthcare, Digital Signage



KYOCERA AVX 1004369PT is a versatile off-board PCB antenna ideal for 5 GHz Wi-Fi applications where off-board implementation is advantageous and necessary.

1004369PT is a mixed polarized antenna that offers easy on-the-go tuning capability right on the antenna face, that is ideal for prototyping. The tuned antenna can then be hardwired by KYOCERA AVX for mass production.

Custom cable and connector options are available. Please contact us for more information.

PCB WiFi Tunable Embedded Antenna with Cable

5.150 - 5.825 GHz

KEY BENEFITS

Stay-in-Tune

KYOCERA AVX antenna technology provides superior RF field containment, resulting in less interaction with surrounding components.

Quicker Time-to-Market

By optimizing antenna size, performance and emissions, customer and regulatory specifications are more easily met.

Reliability

Products are the latest RoHS version compliant

APPLICATIONS

- Embedded design
- Cellular, Headsets, Tablets
- Gateway, Access Point
- Handheld
- Telematics Tracking
- Healthcare M2M, Industrial devices
- Smart Grid
- OBD-II

Electrical Specifications

Typical Performance using 140 mm cable tested on PC-ABS

Frequency	5.150 – 5.825 GHz
Peak Gain	3.7 dBi
Average Efficiency	76%
VSWR Match	2.0 :1 max
Feed Point Impedance	50 ohms unbalanced
Polarization	Mixed
Power Handling	2 Watt CW

Mechanical Specifications & Ordering Part Number

Ordering Part #	1004369PT-AA80L0140
Dimensions (mm)	18.0 x 12.8 x 0.4 (Height up to 2.2 at soldering point)
Weight (grams)	1.1
Cable/Connector (mm)	Length: 140, Diameter: 1.37, Color: Black; u.FI compatible connector
Mounting	3M Adhesive on bottom side of antenna
Packaging	PE bags

*Additional variations available with different cable lengths, colors and connectors.

5 GHz KYOCERA AVX Embedded Antenna Specifications
 KYOCERA AVX produces a wide variety of standard and custom antennas to meet user needs.

Typical VSWR, Efficiency and Peak Gain plots

Measured in free space with PC/ABS loading and 140 mm cable

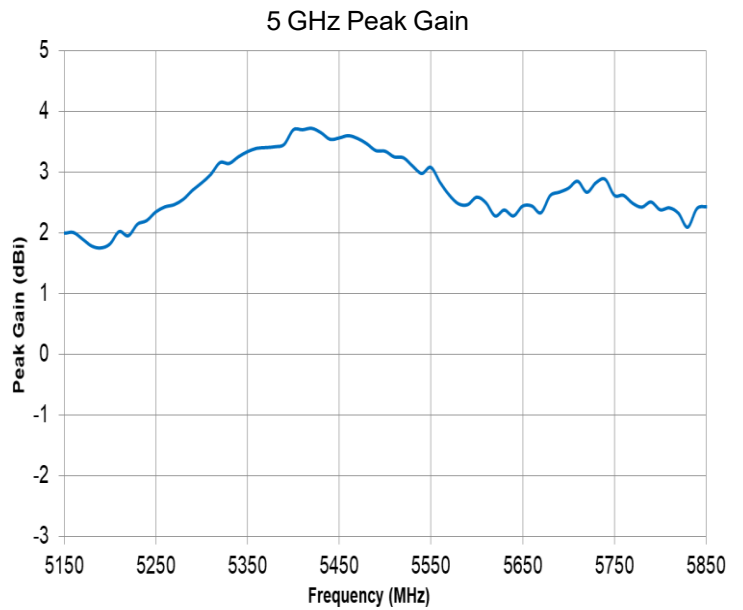
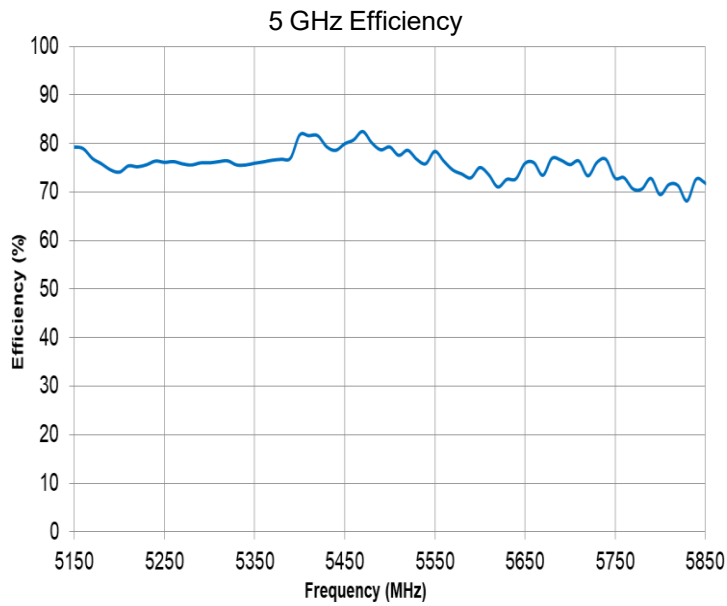
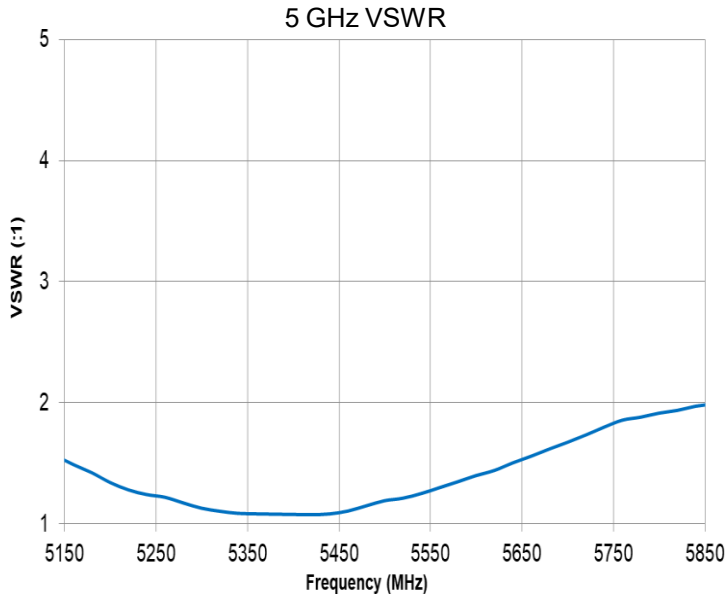

5 GHz KYOCERA AVX Embedded Antenna Specifications
 KYOCERA AVX produces a wide variety of standard and custom antennas to meet user needs.

Radiation Patterns Plots

Measured with PC/ABS loading and 140 mm cable
 Typical Performance @ 5200 MHZ

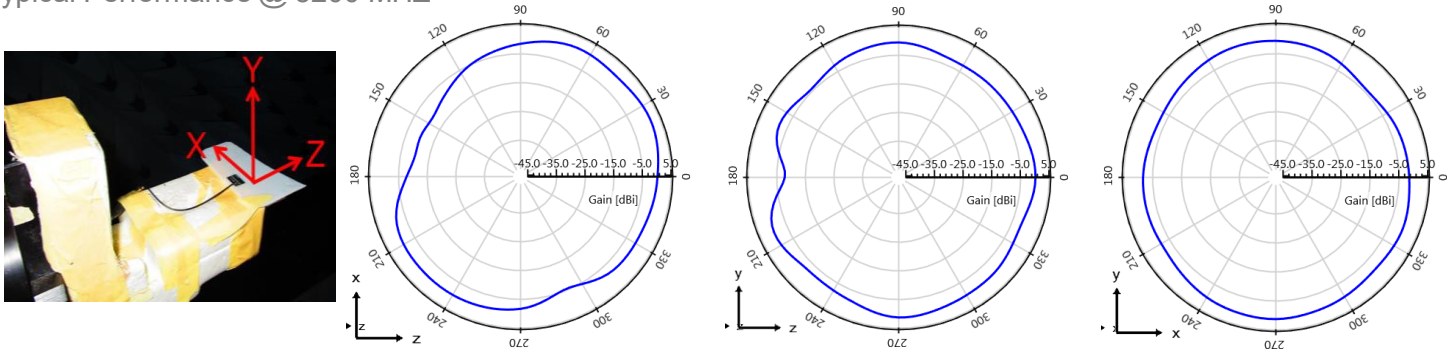

Antenna Tuning Procedure

This antenna has unique features enabling limited range RF tuning by solder bridging or cutting specified area. Ease of tuning for any application on the fly with a soldering iron and knife. Tuning optional if required.

Antenna Tuning (Low)

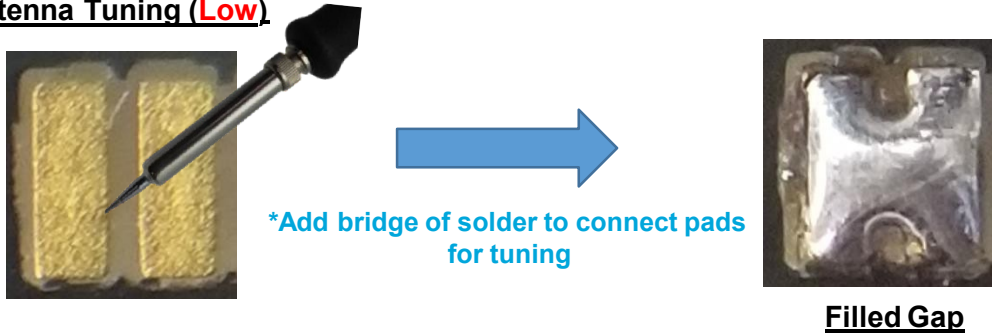

Antenna Tuning (High)

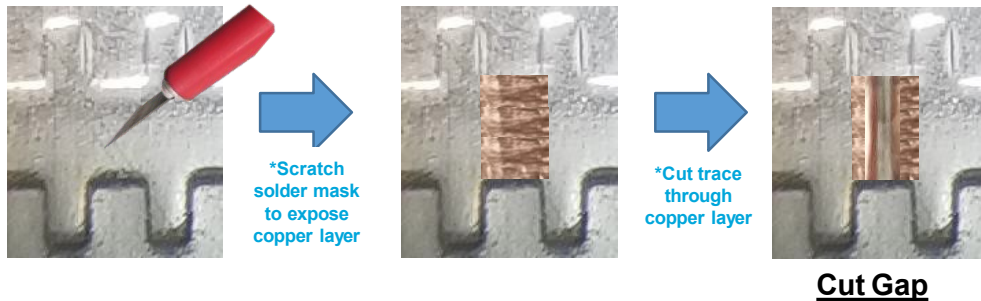

5 GHz KYOCERA AVX Embedded Antenna Specifications
 KYOCERA AVX produces a wide variety of standard and custom antennas to meet user needs.

Antenna Tuning

This antenna has unique features enabling limited range RF tuning by solder bridging or cutting specified area. Ease of tuning for any application on the fly with a soldering iron and knife. Tuning optional if required.

Antenna Tuning Structure

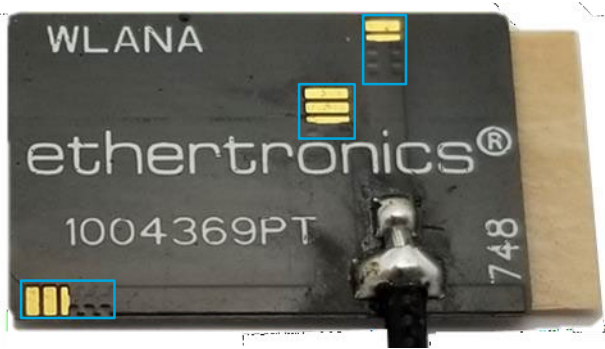

*Area highlighted used for antenna matching and tuning

Antenna Tuning (Low)



*Add bridge of solder to connect pads for tuning

Antenna Tuning (High)



*Cut Pads for tuning

Antenna (Matching)



*Add solder bridge or cut pads to match antenna to different environments

5 GHz KYOCERA AVX Embedded Antenna Specifications
 KYOCERA AVX produces a wide variety of standard and custom antennas to meet user needs.

Tuning Options (Low)

Stages 2-4 (Tuning antenna "Low" with solder bridge)

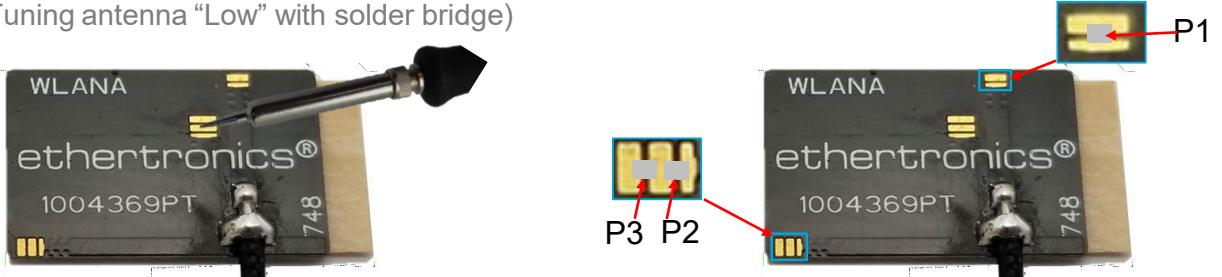

***Tune Frequency Lower**

Apply **Solder Bridge** to designated Stages for optimal tuning.

	Stage	Pads	Frequency Shift (MHz)
Shift Low	Stage 1 (Baseline)	N/A	0
	Stage 2	Bridge P1	-57
	Stage 3	Bridge P2	-89
	Stage 4	Bridge P2 + P3	-156
Shift High	Stage 5	cut C1	38
	Stage 6	cut C2	120
	Stage 7	cut C3	220
	Stage 8	cut C4	50
	Stage 9	cut C5	127
	Stage 10	cut C6	217

	Stage	Pads	Bandwidth (MHz)
Antenna Matching	Stage 1 (Baseline)	N/A	0
	Stage 11	cut C7	55
	Stage 12	cut C8	90
	Stage 13	cut C9	224

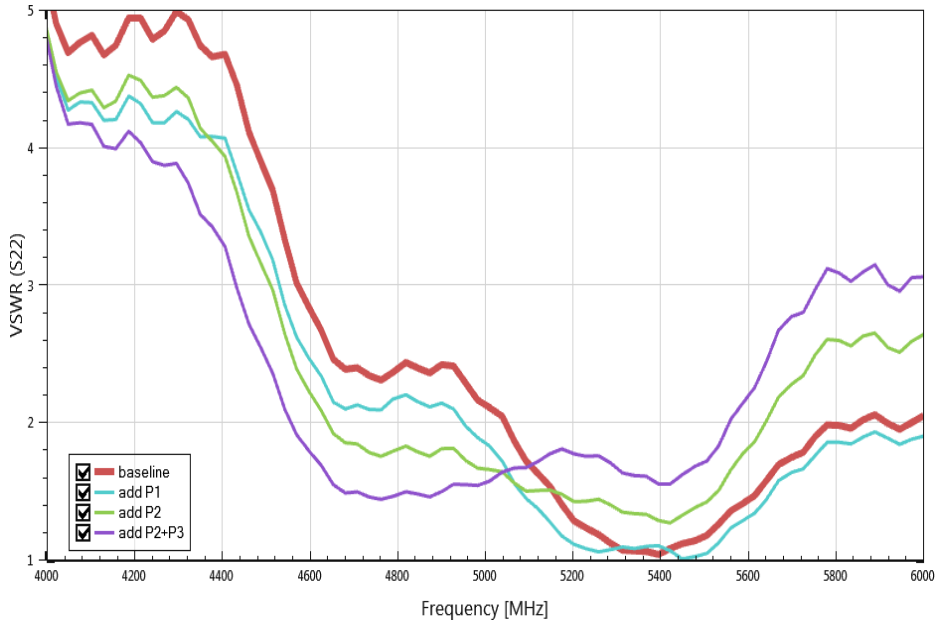

*Measured in free space with PC/ABS loading and 140 mm cable

Stage 1 (Baseline)



Stage 2 P1



Stage 3



Stage 4



5 GHz KYOCERA AVX Embedded Antenna Specifications
 KYOCERA AVX produces a wide variety of standard and custom antennas to meet user needs.

Tuning Options (High)

Stages 5-10 (Tuning antenna "High" applying cut on designated area)

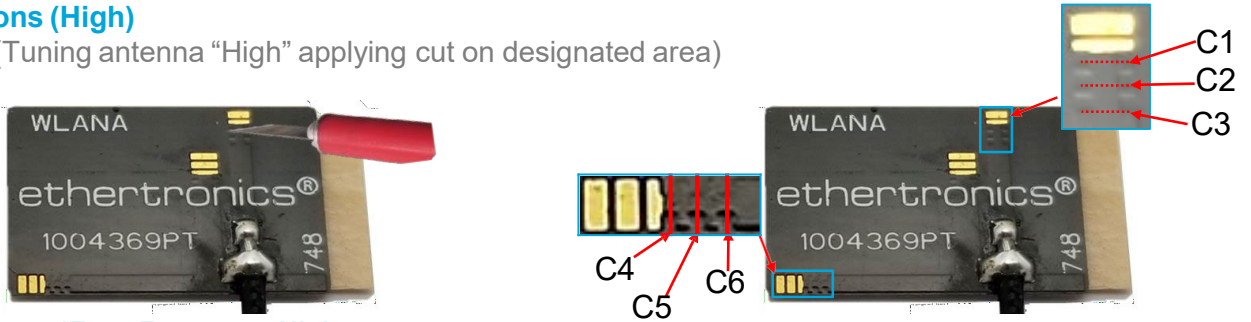

***Tune Frequency Higher**

Apply Cut to designated stage for optimal tuning.

Stage	Pads	Frequency Shift (MHz)	
Stage 1 (Baseline)	N/A	0	
Shift Low	Stage 2	Bridge P1	-57
	Stage 3	Bridge P2	-89
	Stage 4	Bridge P2 + P3	-156
	Stage 5		cut C1
Shift High	Stage 6	cut C2	120
	Stage 7	cut C3	220
	Stage 8	cut C4	50
	Stage 9	cut C5	127
	Stage 10	cut C6	217

Stage	Pads	Bandwidth (MHz)	
Stage 1 (Baseline)	N/A	0	
Antenna Matching	Stage 11	cut C7	55
	Stage 12	cut C8	90
	Stage 13	cut C9	224

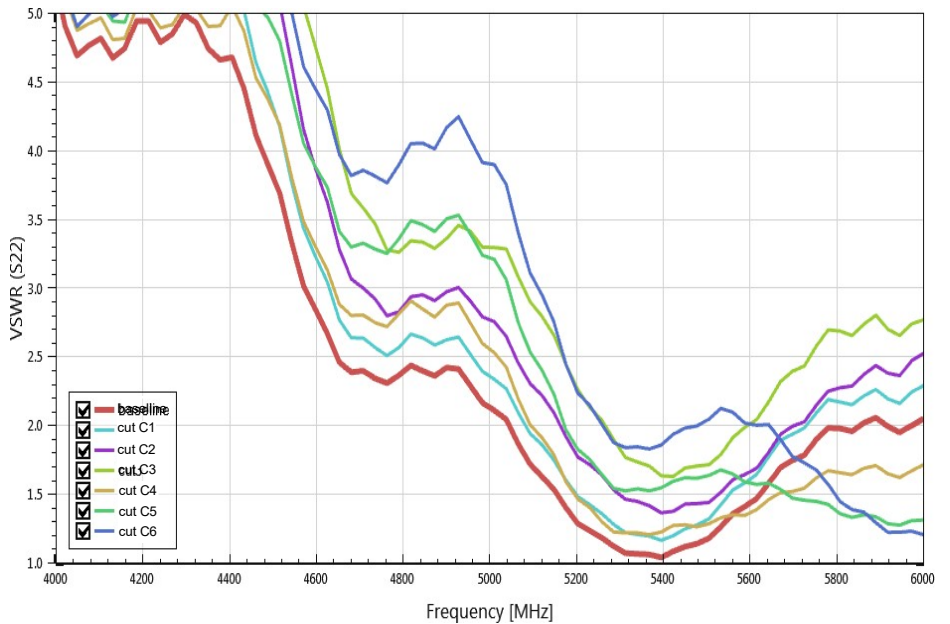

*Measured in free space with PC/ABS loading and 140 mm cable

Stage 1 (Baseline)



Stage 4



Stage 5



Stage 6



Stage 7



Stage 8



Stage 9



5 GHz KYOCERA AVX Embedded Antenna Specifications
 KYOCERA AVX produces a wide variety of standard and custom antennas to meet user needs.

Antenna Matching

Stages 11-13 (Match antenna by applying cut on designated area)

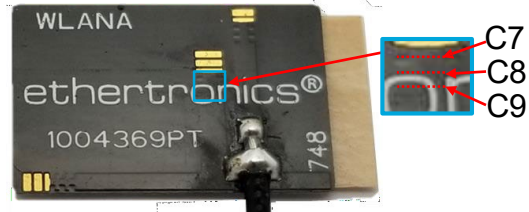

***Improve Antenna Matching**
 Apply Cut to designated stage for optimal matching.

Stage	Pads	Frequency Shift (MHz)	
Stage 1 (Baseline)	N/A	0	
Shift Low	Stage 2	Bridge P1	-57
	Stage 3	Bridge P2	-89
	Stage 4	Bridge P2 + P3	-156
Shift High	Stage 5	cut C1	38
	Stage 6	cut C2	120
	Stage 7	cut C3	220
	Stage 8	cut C4	50
	Stage 9	cut C5	127
	Stage 10	cut C6	217

Stage	Pads	Bandwidth (MHz)	
Stage 1 (Baseline)	N/A	0	
Antenna Matching	Stage 11	cut C7	55
	Stage 12	cut C8	90
	Stage 13	cut C9	224

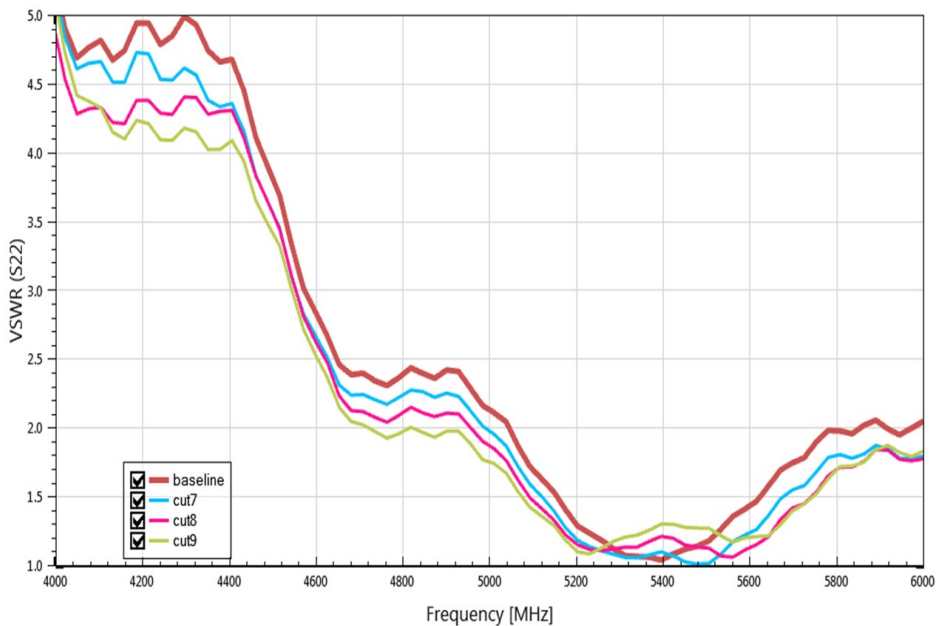

*Measured in free space with PC/ABS loading and 140 mm cable

Stage 1 (Baseline)



Stage 11



C7

Stage 12



C8

Stage 13



C9

5 GHz KYOCERA AVX Embedded Antenna Specifications
 KYOCERA AVX produces a wide variety of standard and custom antennas to meet user needs.

Mechanical Dimensions

Typical antenna dimensions (mm)

Part Number	A (mm)	B (mm)	C (mm)	D (mm)	Connector Orientation
1004369PT-AA80L0140	18.0 ± 0.3	12.8 ± 0.3	2.2 (max)	140 ± 3.0	Face Down

*Total Height of 2.2 mm includes the cable solder connection
 Thickness of 0.4 mm includes PCB + adhesive thicknesses

*Connector shown in photo below is "Face Down"

