

NACZ Series

Surface Mount Aluminum Electrolytic Capacitors



FEATURES

- CYLINDRICAL V-CHIP CONSTRUCTION FOR SURFACE MOUNTING
- VERY LOW IMPEDANCE & HIGH RIPPLE CURRENT AT 100KHZ
- SUITABLE FOR DC-DC CONVERTER, DC-AC INVERTER, ETC.
- NEW EXPANDED CV RANGE, UP TO 3300 μ F
- NEW HIGH TEMPERATURE REFLOW "M1" VERSION
- DESIGNED FOR AUTOMATIC MOUNTING AND REFLOW SOLDERING
- **MEETS THE REQUIREMENTS OF AEC-Q200***

*Contact NIC for supporting test data

See **NAZT** for
New Designs



CHARACTERISTICS

Rated Voltage Rating	6.3 ~ 50Vdc
Rated Capacitance Range	4.7 ~ 3300 μ F
Operating Temp. Range	-55 ~ +105°C
Capacitance Tolerance	\pm 20% (M)
Max. Leakage Current After 2 Minutes @ 20°C	0.01CV Or 3 μ A, whichever is greater
Tan δ @ 120Hz/20°C	W.V. (Vdc)
	S.V. (Vdc)
	ϕ 4 ~ ϕ 6.3mm Dia.
	ϕ 8 ~ ϕ 16mm Dia.
Low Temperature Stability Impedance Ratio @ 120Hz	W.V. (Vdc)
	Z-40°C/Z+20°C
	Z-55°C/Z+20°C
Load Life Test @ 105°C 4 ~ 6mm Dia. 1,000 hours 8 ~ 12.5mm Dia. 2,000 hours	Capacitance Change
	Tan δ
	Leakage Current

LOW IMPEDANCE AT HIGH FREQUENCY

INDUSTRY STANDARD
STYLE FOR SWITCHERS
AND CONVERTERS

LOW ESR COMPONENT
LIQUID ELECTROLYTE
For Performance Data
see www.LowESR.com

STANDARD PRODUCT AND CASE SIZE TABLE D ϕ x L (mm)

Cap (μ F)	Code	Working Voltage (Vdc)					
		6.3	10	16	25	35	50
4.7	4R7	-	-	-	-	4x6.3	-
10	100	-	-	-	4x6.3	5x6.3	6.3x6.3
15	150	-	-	-	-	5x6.3	-
22	220	-	4x6.3	5x6.3	5x6.3	5x6.3	6.3x6.3
33	330	-	5x6.3	-	6.3x6.3	6.3x6.3*	6.3x8*
47	470	5x6.3	-	6.3x6.3	6.3x6.3	6.3x6.3*	6.3x8*
56	560	-	-	-	6.3x6.3	-	-
68	680	-	6.3x6.3	6.3x6.3	6.3x6.3	6.3x8	8x10.5
100	101	6.3x6.3	-	6.3x6.3	6.3x8	8x10.5	8x10.5*
120	121	-	6.3x6.3	-	-	-	-
150	151	6.3x6.3	6.3x6.3*	6.3x8*	8x10.5	8x10.5	10x10.5
220	221	6.3x6.3	-	6.3x8*	8x10.5	8x10.5*	10x10.5*
330	331	6.3x8	8x10.5	8x10.5	8x10.5	10x10.5*	12.5x14*
470	471	8x10.5	8x10.5	8x10.5	10x10.5	12.5x14	-
680	681	8x10.5	-	10x10.5*	-	12.5x14	-
1000	102	8x10.5	10x10.5	-	12.5x14	-	16x17
1500	152	10x10.5	-	12.5x14	-	-	-
3300	332	12.5x14	-	-	-	-	-

*Available for Automotive Applications. Parts in **shaded cells** are available with high temperature reflow (see part numbering system)

NACZ Series

Surface Mount Aluminum Electrolytic Capacitors



STANDARD VALUES, CASE SIZES AND SPECIFICATIONS

NIC Part Number*	Cap. (µF)	W.V. (Vdc)	Dissipation Factor (Tan δ)	Max. Ripple Current (mA) +105°C, 100KHz	Max. Impedance (Ω) +20°C, 100KHz	Load Life Hours @ +105°C	
NACZ470M6.3V5X6.3TR15F	47	6.3	0.24	150	0.76	1,000	
NACZ101M6.3V6.3X6.3TR15F	100		0.24	230	0.44	1,000	
NACZ151M6.3V6.3X6.3TR15F	150		0.24	230	0.44	1,000	
NACZ221M6.3V6.3X6.3TR15F	220		0.24	230	0.44	1,000	
NACZ331M6.3V6.3X8TR15F	330		0.24	280	0.34	1,000	
NACZ471M6.3V8X10.5TR15F	470		0.28	450	0.17	2,000	
NACZ681M6.3V8X10.5TR15F	680		0.28	450	0.17	2,000	
NACZ102M6.3V8X10.5TR15F	1000		0.28	450	0.17	2,000	
NACZ152M6.3V10X10.5TR15F	1500		0.29	670	0.09	2,000	
NACZ332M6.3V12.5X14TR15F	3300		0.32	900	0.066	2,000	
NACZ220M10V4X6.3TR15F	22	10	0.20	80	1.80	1,000	
NACZ330M10V5X6.3TR15F	33		0.20	150	0.76	1,000	
NACZ680M10V6.3X6.3TR15F	68		0.20	230	0.44	1,000	
NACZ121M10V6.3X6.3TR15F	120		0.20	230	0.44	1,000	
NACZ151M10V6.3X6.3TR15F	150*		0.20	230	0.44	1,000	
NACZ331M10V8X10.5TR15F	330		0.24	450	0.17	2,000	
NACZ471M10V8X10.5TR15F	470		0.24	450	0.17	2,000	
NACZ102M10V10X10.5TR15F	1000		0.24	670	0.09	2,000	
NACZ220M16V5X6.3TR15F	22		16	0.16	150	0.76	1,000
NACZ470M16V6.3X6.3TR15F	47			0.16	230	0.44	1,000
NACZ680M16V6.3X6.3TR15F	68	0.16		230	0.44	1,000	
NACZ101M16V6.3X6.3TR15F	100	0.16		230	0.44	1,000	
NACZ151M16V6.3X8TR15F	150*	0.16		280	0.34	1,000	
NACZ221M16V6.3X8TR15F	220*	0.16		280	0.34	1,000	
NACZ331M16V8X10.5TR15F	330	0.20		450	0.17	2,000	
NACZ471M16V8X10.5TR15F	470	0.20		450	0.17	2,000	
NACZ681M16V10X10.5TR15F	680*	0.20		670	0.09	2,000	
NACZ152M16V12.5X14TR15F	1500	0.21		900	0.066	2,000	
NACZ100M25V4X6.3TR15F	10	25	0.14	80	1.80	1,000	
NACZ220M25V5X6.3TR15F	22		0.14	150	0.76	1,000	
NACZ330M25V6.3X6.3TR15F	33		0.14	230	0.44	1,000	
NACZ470M25V6.3X6.3TR15F	47		0.14	230	0.44	1,000	
NACZ560M25V6.3X6.3TR15F	56		0.14	230	0.44	1,000	
NACZ680M25V6.3X6.3TR15F	68		0.14	230	0.44	1,000	
NACZ101M25V6.3X8TR15F	100		0.14	280	0.34	1,000	
NACZ151M25V8X10.5TR15F	150		0.16	450	0.17	2,000	
NACZ221M25V8X10.5TR15F	220		0.16	450	0.17	2,000	
NACZ331M25V8X10.5TR15F	330		0.16	450	0.17	2,000	
NACZ471M25V10X10.5TR15F	470	0.16	670	0.09	2,000		
NACZ102M25V12.5X14TR15F	1000	0.16	900	0.066	2,000		
NACZ4R7M35V4X6.3TR15F	4.7	35	0.12	80	1.80	1,000	
NACZ100M35V5X6.3TR15F	10		0.12	150	0.76	1,000	
NACZ150M35V5X6.3TR15F	15		0.12	150	0.76	1,000	
NACZ220M35V5X6.3TR15F	22		0.12	150	0.76	1,000	
NACZ330M35V6.3X6.3TR15F	33*		0.12	230	0.44	1,000	
NACZ470M35V6.3X6.3TR15F	47*		0.12	230	0.44	1,000	
NACZ680M35V6.3X8TR15F	68		0.12	280	0.34	1,000	
NACZ101M35V8X10.5TR15F	100		0.14	450	0.17	2,000	
NACZ151M35V8X10.5TR15F	150		0.14	450	0.17	2,000	
NACZ221M35V8X10.5TR15F	220*		0.14	450	0.17	2,000	
NACZ331M35V10X10.5TR15F	330*	0.14	670	0.09	2,000		
NACZ471M35V12.5X14TR15F	470	0.14	900	0.066	2,000		
NACZ681M35V12.5X14TR15F	680	0.14	900	0.066	2,000		

*Available for Automotive Applications. Parts in shaded cells are available with high temperature reflow (see part numbering system)

NACZ Series

Surface Mount Aluminum Electrolytic Capacitors



STANDARD VALUES, CASE SIZES AND SPECIFICATIONS

NIC Part Number*	Cap. (μF)	W.V. (Vdc)	Dissipation Factor (Tan δ)	Max. Ripple Current (mA) +105°C, 100KHz	Max. Impedance (Ω) +20°C, 100KHz	Load Life Hours @ +105°C
NACZ100M50V6.3X6.3TR15F	10	50	0.10	165	0.88	1,000
NACZ220M50V6.3X6.3TR15F	22		0.10	165	0.88	1,000
NACZ330M50V6.3X8TR15F	33*		0.10	195	0.75	1,000
NACZ470M50V6.3X8TR15F	47*		0.10	195	0.75	1,000
NACZ680M50V8X10.5TR15F	68		0.14	300	0.40	2,000
NACZ101M50V8X10.5TR15F	100*		0.14	300	0.40	2,000
NACZ151M50V10X10.5TR15F	150		0.14	450	0.22	2,000
NACZ221M50V10X10.5TR15F	220*		0.14	450	0.22	2,000
NACZ331M50V12.5X14TR15F	330*		0.14	620	0.14	2,000
NACZ102M50V16X17TR15F	1000		0.14	790	0.078	2,000

*Available for Automotive Applications. Parts in shaded cells are available with high temperature reflow (see part numbering system)

RIPPLE CURRENT FREQUENCY CORRECTION FACTORS

Capacitance (μF)	Frequency			
	100Hz ≤ F < 1KHz	1KHz ≤ F < 10KHz	10KHz ≤ F < 100KHz	100KHz ≤ F
C ≤ 33	0.35	0.70	0.90	1.00
33 < C ≤ 150	0.40	0.85	0.92	1.00
150 < C	0.60	0.85	0.95	1.00

DIMENSIONS (mm)

Case Size	φD±0.5	L max.	A±0.2	B±0.2	I±0.3	W	P±0.3
4x6.3	4.0	6.3	4.3	4.3	1.8	0.5~0.8	1.0
5x6.3	5.0	6.3	5.3	5.3	2.2	0.5~0.8	1.4
6.3x6.3	6.3	6.3	6.6	6.6	2.5	0.5~0.8	2.2
6.3X8	6.3	8.0	6.6	6.6	2.5	0.5~0.8	2.2
8X10.5	8.0	10.5	8.3	8.3	2.9	0.7~1.1	3.2
10X10.5	10.0	10.5	10.3	10.3	3.2	0.7~1.4	4.6
12.5x14	12.5	14.0	12.8	12.8	4.5	1.0~1.4	4.6
16x17	16.0	17.0	16.3	16.3	5.0	1.7~2.1	7.0

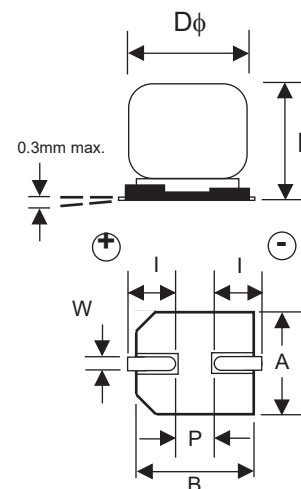

PART NUMBER SYSTEM

NACZ 101 M 16V 6.3x6.3 TR 15 M1 Y E

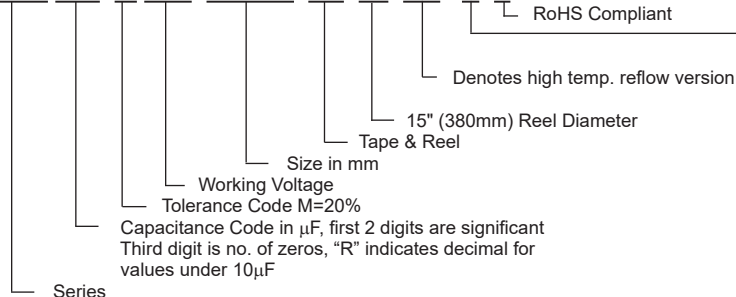

Optional: Suitable for automotive equipment, sourced to special production and inspection at IATF-16949 certified production site.

Case Diameter	Termination Material
4 ~ 12.5mm φ	97% Sn, 3% Bi
16mm	100% Sn

Performance Passives By Design



PEAK REFLOW SOLDERING TEMPERATURES AND DURATIONS (STANDARD VERSION)

Case Size	Preheat: 150°C ~ 180°C	Max. Soldering Temperature	Max. Exposure Time at Max. Soldering Temperature	Max. Exposure Time Above +217°C	Max. Exposure Time Above +200°C	Multiple Reflow Exposure
4x6.3	120 seconds max.	+250°C	5 seconds	60 seconds	70 seconds	2 times max.
5x6.3	120 seconds max.	+250°C	5 seconds	60 seconds	70 seconds	2 times max.
6.3x6.3	120 seconds max.	+250°C	5 seconds	60 seconds	70 seconds	2 times max.
6.3x8	120 seconds max.	+250°C	5 seconds	60 seconds	70 seconds	2 times max.
8x10.5	120 seconds max.	+245°C	5 seconds	50 seconds	60 seconds	2 times max.
10x10.5	120 seconds max.	+240°C	5 seconds	40 seconds	50 seconds	2 times max.
12.5x14	120 seconds max.	+240°C	5 seconds	40 seconds	50 seconds	2 times max.
16x17	120 seconds max.	+230°C	5 seconds	30 seconds	50 seconds	2 times max.

PEAK REFLOW SOLDERING TEMPERATURES AND DURATIONS (M1 VERSION)

Case Size	Preheat: 150°C ~ 180°C	Max. Soldering Temperature	Max. Exposure Time at Max. Soldering Temperature	Max. Exposure Time Above +200°C	Max. Exposure Time Above +230°C	Multiple Reflow Exposure
4x6.3	120 seconds max.	+255°C	5 seconds	60 seconds	30 seconds	2 times max.
5x6.3	120 seconds max.	+255°C	5 seconds	60 seconds	30 seconds	2 times max.
6.3x6.3	120 seconds max.	+255°C	5 seconds	60 seconds	30 seconds	2 times max.
6.3x8	120 seconds max.	+255°C	5 seconds	60 seconds	30 seconds	2 times max.
8x10.5	120 seconds max.	+250°C	5 seconds	60 seconds	30 seconds	2 times max.
10x10.5	120 seconds max.	+250°C	5 seconds	60 seconds	20 seconds	2 times max.

RECOMMENDED REFLOW SOLDERING PROFILE

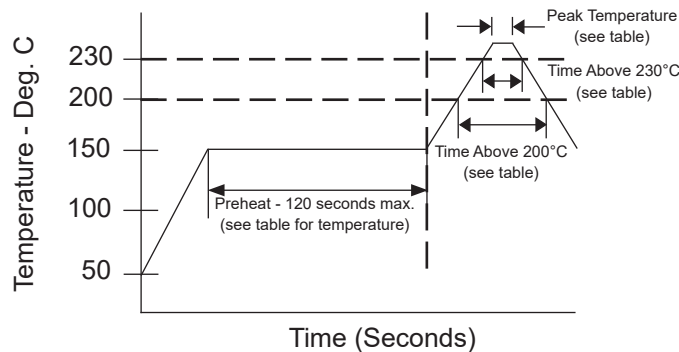

RECOMMENDED LAND PATTERN DIMENSIONS (mm)

Case Size	a	b	c
4 φ	1.0	2.6	1.8
5 φ	1.4	3.0	1.8
6.3 φ	1.8	3.6	1.8
8 φ	2.8	4.1	2.1
10 φ	4.3	4.4	2.5
12.5 φ	4.3	5.8	2.5
16 φ	6.6	6.5	5.0

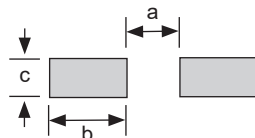

Review & Compare Reflow Soldering Heat Limits
V-chip SMT Aluminum Electrolytic Capacitors
www.niccomp.com/RSL

CARRIER TAPE

Case Size	A ±0.5	B ±0.2	C ±0.3	D ±0.1	P ±0.1	T ±0.2
4 x 6.3	4.7	4.7	12.0	5.5	8.0	6.4
5 x 6.3	5.7	5.7	12.0	5.5	12.0	6.4
6.3 x 6.3	7.0	7.0	16.0	7.5	12.0	6.5
6.3 x 8	7.0	7.0	16.0	7.5	12.0	8.2
8 X 10.5	8.7	8.7	24.0	11.5	16.0	11.1
10 x 10.5	10.7	10.7	24.0	11.5	16.0	11.2
12.5 x 14	13.2	13.2	32.0	14.2	24.0	14.3
16 x 17	17.5	17.5	44.0	20.2	28.0	17.3

TAPING SPECIFICATIONS (mm)

1. Both Leader and Trailer tape: Minimum 40mm (1.57") empty carrier tape pockets.
2. Leader tape: Approximately 20cm of cover tape at leader.
3. Connection: Maximum 3 connections (slices) per reel.

CARRIER

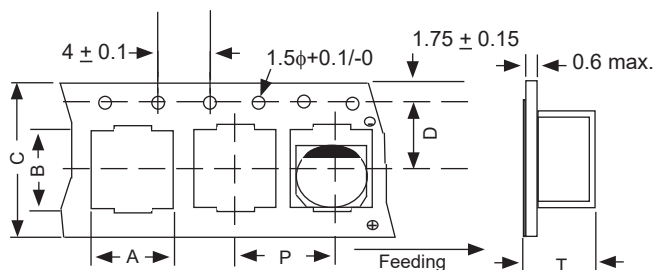

PRECAUTIONS

Please review the notes on correct use, safety and precautions found at <https://www.niccomp.com/resource/files/aluminum/AlumApplInfoCautions.pdf>. If in doubt or uncertainty, please review your specific application - process details with NIC's technical support personnel: tpmg@niccomp.com

V-Chip 380mm Reels (TR15 suffix)

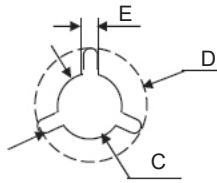
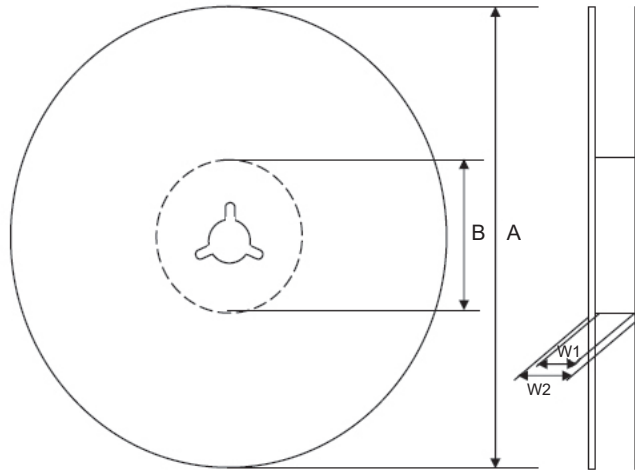

Dimensions (mm)

Case Diameter	Tape Width	W1	W2
4x6.3, 5x6.3	12.0	12.4 ~ 14.4	15.5 ~ 20.0
6.3x6.3, 6.3x8	16.0	16.4 ~ 18.4	19.5 ~ 24.0
8x10.5, 10x10.5	24.0	24.4 ~ 26.4	27.5 ~ 32.0
12.5x14	32.0	32.4 ~ 35.0	36.2 ~ 38.4
16x17	44.0	44.4 ~ 47.0	48.2 ~ 50.4

Case Size	Tape Width	A	B	C	D	E
4x6.3, 5x6.3	12.0	φ330 ±2.0	φ50~105	φ13 ±0.5	φ21 ±1.0	2.0 ±0.5
6.3x6.3, 6.3x8	16.0					
8x10.5, 10x10.5	24.0					
12.5x14	32.0					
16x17	44.0					

Case Size	15" Reel
	4 x 6.3
5 x 6.3	1,000 pcs
6.3 x 6.3	1,000 pcs
6.3 x 8	900 pcs
8 X 10.5	500 pcs
10 x 10.5	500 pcs
12.5 x 14	250 pcs
16 x 17	200 pcs