

## **Micropower, Single Supply, Rail-to-Rail Input-Output Instrumentation Amplifier and Precision Operational Amplifier**

The ISL28274 is a combination of a micropower instrumentation amplifier (Amp A) with a low power precision amplifier (Amp B) in a single package. The ISL28474 consists of two micropower instrumentation amplifiers (Amp A) and two low power precision amplifiers (Amp B) in a single package. The amplifiers are optimized for operation at 2.4V to 5V single supplies. Inputs and outputs can operate rail-to-rail. As with all instrumentation amplifiers, a pair of inputs provide a high common-mode rejection and are completely independent from a pair of feedback terminals. The feedback terminals allow zero input to be translated to any output offset, including ground. A feedback divider controls the overall gain of the amplifier. The additional precision amplifier can be used to generate higher gain, with smaller feedback resistors or used to generate a reference voltage.

The instrumentation amp (Amp A) is compensated for a gain of 100 or more and the precision amp (Amp B) is unity gain stable. Both amplifiers have PMOS inputs that provide less than 30pA input bias currents.

The amplifiers can be operated from one lithium cell or two Ni-Cd batteries. The amplifiers input range goes from below ground to slightly above positive rail. The output stage swings completely to ground or positive supply; no pull-up or pull-down resistors are needed.

### **Ordering Information**

<b>PART NUMBER (Note)</b>	<b>PART MARKING</b>	<b>PACKAGE (Pb-free)</b>	<b>PKG. DWG. #</b>
ISL28274FAZ*	28274 FAZ	16 Ld QSOP	MDP0040
ISL28474FAZ*	ISL28474 FAZ	24 Ld QSOP	MDP0040

\*Add "-T7" suffix for tape and reel. Please refer to TB347 for details on reel specifications.

NOTE: These Intersil Pb-free plastic packaged products employ special Pb-free material sets; molding compounds/die attach materials and 100% matte tin plate PLUS ANNEAL - e3 termination finish, which is RoHS compliant and compatible with both SnPb and Pb-free soldering operations. Intersil Pb-free products are MSL classified at Pb-free peak reflow temperatures that meet or exceed the Pb-free requirements of IPC/JEDEC J STD-020.

### **Features**

- Combination of IN-AMP and OP-AMP in a single package
- 120µA supply current for ISL28274
- Input offset voltage IN-AMP 500µV max
- Input offset voltage OP-AMP 225µV max
- 30pA max input bias current
- 100dB CMRR and PSRR
- Single supply operation of 2.4V to 5.0V
- Ground sensing
- Input voltage range is rail-to-rail and output swings rail-to-rail
- Pb-free available (RoHS compliant)



### **Applications**

- 4mA to 20mA loops
- Industrial process control
- Medical instrumentation

Pinout

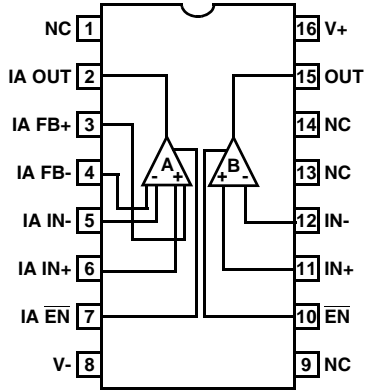

ISL28274  
(16 LD QSOP)  
TOP VIEW

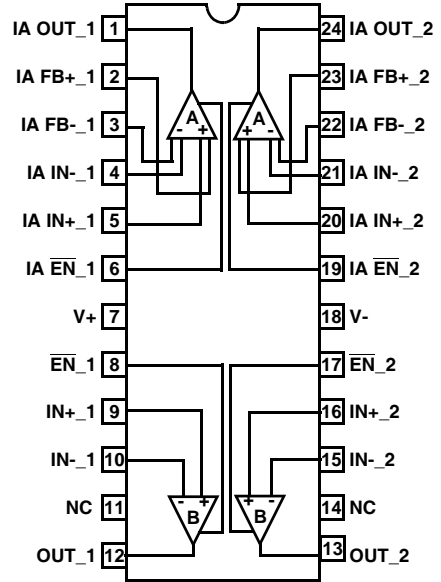

IA = Instrumentation Amplifier  
 = Instrumentation Amplifier  
 = Precision Amplifier

ISL28474  
(24 LD QSOP)  
TOP VIEW



IA = Instrumentation Amplifier  
 = Instrumentation Amplifier  
 = Precision Amplifier

# ISL28274, ISL28474

## Absolute Maximum Ratings (T<sub>A</sub> = +25°C)

Supply Voltage	5.5V
Supply Turn On Voltage Slew Rate	1V/μs
Input Current (IN, FB)	5mA
Differential Input Voltage (IN, FB)	0.5V
Input Voltage	V <sub>-</sub> - 0.5V to V <sub>+</sub> + 0.5V
ESD Rating	
Human Body Model	.3kV
Machine Model	.300V

## Thermal Information

Thermal Resistance	θ <sub>JA</sub> (°C/W)
16 Ld QSOP Package	112
24 Ld QSOP Package	88
Output Short-Circuit Duration	Indefinite
Ambient Operating Temperature Range	-40°C to +125°C
Storage Temperature Range	-65°C to +150°C
Operating Junction Temperature	+125°C
Pb-free reflow profile	see link below
<a href="http://www.intersil.com/pbfree/Pb-FreeReflow.asp">http://www.intersil.com/pbfree/Pb-FreeReflow.asp</a>	

**CAUTION:** Do not operate at or near the maximum ratings listed for extended periods of time. Exposure to such conditions may adversely impact product reliability and result in failures not covered by warranty.

**IMPORTANT NOTE:** All parameters having Min/Max specifications are guaranteed. Typical values are for information purposes only. Unless otherwise noted, all tests are at the specified temperature and are pulsed tests, therefore: T<sub>J</sub> = T<sub>C</sub> = T<sub>A</sub>

**Electrical Specifications** INSTRUMENTATION AMPLIFIER "A" V<sub>+</sub> = +5V, V<sub>-</sub> = GND, V<sub>CM</sub> = 1/2V<sub>+</sub>, T<sub>A</sub> = +25°C, unless otherwise specified. For ISL28274 ONLY. Boldface limits apply over the operating temperature range, -40°C to +125°C, temperature data established by characterization

PARAMETER	DESCRIPTION	CONDITIONS	MIN (Note 1)	TYP	MAX (Note 1)	UNIT	
V <sub>OS</sub>	Input Offset Voltage	ISL28274	-400 <b>-750</b>	35	400 <b>750</b>	μV	
		ISL28474	-500 <b>-750</b>	35	500 <b>750</b>	μV	
TCV <sub>OS</sub>	Input Offset Voltage Temperature Coefficient	Temperature = -40°C to +125°C		3		μV/°C	
I <sub>OS</sub>	Input Offset Current between IN+ and IN-, and between FB+ and FB-	(see Figure 44 for extended temperature range) -40°C to +85°C	-30 <b>-80</b>	±5	30 <b>80</b>	pA	
I <sub>B</sub>	Input Bias Current (IN+, IN-, FB+, and FB- terminals)	(see Figure 36 and 37 for extended temperature range) -40°C to +85°C	-30 <b>-80</b>	±10	30 <b>80</b>	pA	
e <sub>N</sub>	Input Noise Voltage	f = 0.1Hz to 10Hz		6		μV <sub>P-P</sub>	
	Input Noise Voltage Density	f <sub>o</sub> = 1kHz		78		nV/√Hz	
i <sub>N</sub>	Input Noise Current Density	f <sub>o</sub> = 1kHz		0.19		pA/√Hz	
R <sub>IN</sub>	Input Resistance			1		GΩ	
V <sub>IN</sub>	Input Voltage Range	V <sub>+</sub> = 2.4V to 5.0V	0		V <sub>+</sub>	V	
CMRR	Common Mode Rejection Ratio	V <sub>CM</sub> = 0V to 5V	80 <b>75</b>	100		dB	
PSRR	Power Supply Rejection Ratio	V <sub>+</sub> = 2.4V to 5V	80 <b>75</b>	100		dB	
E <sub>G</sub>	Gain Error	R <sub>L</sub> = 100kΩ to 2.5V		-0.2		%	
SR	Slew Rate	R <sub>L</sub> = 1kΩ to V <sub>CM</sub>	ISL28274	0.40 <b>0.35</b>	0.5	0.65 <b>0.70</b>	V/μs
			ISL28474	0.40 <b>0.35</b>	0.5	0.7 <b>0.75</b>	V/μs
GBWP	Gain Bandwidth Product	V <sub>OUT</sub> = 10mV <sub>P-P</sub> ; R <sub>L</sub> = 10kΩ		6		MHz	

## ISL28274, ISL28474

**Electrical Specifications** OPERATIONAL AMPLIFIER "B"  $V_+ = +5V$ ,  $V_- = GND$ ,  $V_{CM} = 1/2V_+$ ,  $T_A = +25^\circ C$ , unless otherwise specified. For ISL28274 ONLY. Boldface limits apply over the operating temperature range,  $-40^\circ C$  to  $+125^\circ C$ .

PARAMETER	DESCRIPTION	CONDITIONS	MIN (Note 1)	TYP	MAX (Note 1)	UNIT
$V_{OS}$	Input Offset Voltage		-225 <b>-450</b>	$\pm 20$	225 <b>450</b>	$\mu V$
$\frac{\Delta V_{OS}}{\Delta Time}$	Long Term Input Offset Voltage Stability			1.2		$\mu V/Mo$
$\frac{\Delta V_{OS}}{\Delta T}$	Input Offset Drift vs Temperature			2.2		$\mu V/^\circ C$
$I_{OS}$	Input Offset Current	(see Figure 46 for extended temperature range) $-40^\circ C$ to $+85^\circ C$	-30 <b>-80</b>	$\pm 5$	30 <b>80</b>	$\mu A$
$I_B$	Input Bias Current	(see Figures 40 and 41 for extended temperature range) $-40^\circ C$ to $+85^\circ C$	-30 <b>-80</b>	$\pm 10$	30 <b>80</b>	$\mu A$
$e_N$	Input Noise Voltage Peak-to-Peak	$f = 0.1Hz$ to $10Hz$		5.4		$\mu V_{P-P}$
	Input Noise Voltage Density	$f_O = 1kHz$		50		$nV/\sqrt{Hz}$
$i_N$	Input Noise Current Density	$f_O = 1kHz$		0.14		$pA/\sqrt{Hz}$
CMIR	Input Voltage Range	Guaranteed by CMRR test	<b>0</b>		<b>5</b>	V
CMRR	Common-Mode Rejection Ratio	$V_{CM} = 0V$ to $5V$	80 <b>75</b>	100		dB
PSRR	Power Supply Rejection Ratio	$V_+ = 2.4V$ to $5V$	85 <b>80</b>	105		dB
$A_{VOL}$	Large Signal Voltage Gain	$V_O = 0.5V$ to $4.5V$ , $R_L = 100k\Omega$	200 <b>190</b>	300		V/mV
SR	Slew Rate	$R_L = 1k\Omega$ to $V_{CM}$	0.12 <b>0.09</b>	$\pm 0.14$	0.16 <b>0.21</b>	V/ $\mu s$
GBW	Gain Bandwidth Product	$V_{OUT} = 10mV_{P-P}$ ; $R_L = 10k\Omega$		300		kHz

**Electrical Specifications** COMMON ELECTRICAL SPECIFICATIONS  $V_+ = 5V$ ,  $V_- = GND$ ,  $V_{CM} = 1/2V_+$ ,  $T_A = +25^\circ C$ , unless otherwise specified. For ISL28274 ONLY. Boldface limits apply over the operating temperature range,  $-40^\circ C$  to  $+125^\circ C$ .

PARAMETER	DESCRIPTION	CONDITIONS	MIN (Note 1)	TYP	MAX (Note 1)	UNIT
$V_{OUT}$	Maximum Output Voltage Swing	Output low, $R_L = 100k\Omega$ to $V_{CM}$		3	6 <b>30</b>	mV
		Output low, $R_L = 1k\Omega$ to $V_{CM}$		130	175 <b>225</b>	mV
		Output high, $R_L = 100k\Omega$ to $V_{CM}$	4.990 <b>4.97</b>	4.996		V
		Output high, $R_L = 1k\Omega$ to $V_{CM}$	4.800 <b>4.750</b>	4.880		V
$I_{S,ON}$	Supply Current, Enabled	ISL28274 All channels enabled		120	156 <b>175</b>	$\mu A$
		ISL28474 All channels enabled		240	315 <b>350</b>	$\mu A$
$I_{S,OFF}$	Supply Current, Disabled	ISL28274 All channels disabled		4	7 <b>9</b>	$\mu A$
		ISL28474 All channels disabled		10	15 <b>20</b>	$\mu A$
$I_{SC+}$	Short Circuit Sourcing Capability	$R_L = 10\Omega$ to $V_{CM}$	28 <b>24</b>	31		mA

**Electrical Specifications** COMMON ELECTRICAL SPECIFICATIONS  $V_+ = 5V$ ,  $V_- = GND$ ,  $V_{CM} = 1/2V_+$ ,  $T_A = +25^\circ C$ , unless otherwise specified. For ISL28274 ONLY. Boldface limits apply over the operating temperature range,  $-40^\circ C$  to  $+125^\circ C$ .  
(Continued)

PARAMETER	DESCRIPTION	CONDITIONS	MIN (Note 1)	TYP	MAX (Note 1)	UNIT
$I_{SC-}$	Short Circuit Sinking Capability	$R_L = 10\Omega$ to VCM	24 <b>20</b>	26		mA
$V_+$	Minimum Supply Voltage		<b>2.4</b>			V
$V_{INH}$	Enable Pin High Level		<b>2</b>			V
$V_{INL}$	Enable Pin Low Level				<b>0.8</b>	V
$I_{ENH}$	Enable Pin Input Current	$V_{EN} = 5V$		0.8	1 <b>1.3</b>	$\mu A$
$I_{ENL}$	Enable Pin Input Current	$V_{EN} = 0V$		0 <b>26</b>	50 <b>100</b>	$\mu A$

NOTE:

- Parts are 100% tested at  $+25^\circ C$ . Over temperature limits established by characterization and are not production tested.

**Typical Performance Curves**  $V_+ = +5V$ ,  $V_- = GND$ ,  $V_{CM} = 1/2V_+$ ,  $T_A = +25^\circ C$ , unless otherwise specified.

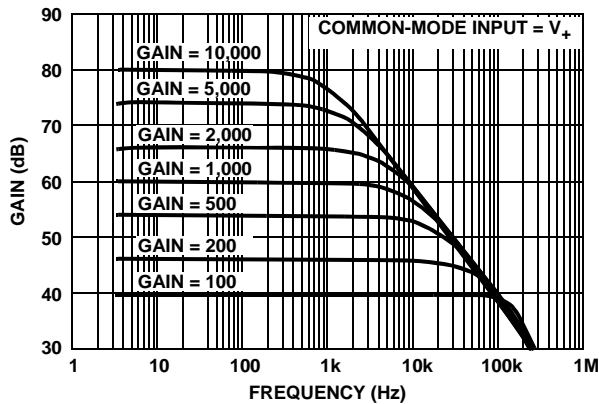

FIGURE 1. AMPLIFIER "A" (IN-AMP) FREQUENCY RESPONSE vs CLOSED LOOP GAIN

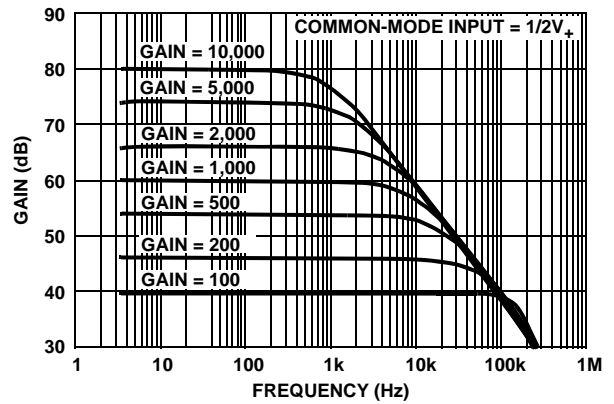

FIGURE 2. AMPLIFIER "A" (IN-AMP) FREQUENCY RESPONSE vs CLOSED LOOP GAIN,  $V_{CM} = 1/2V_+$

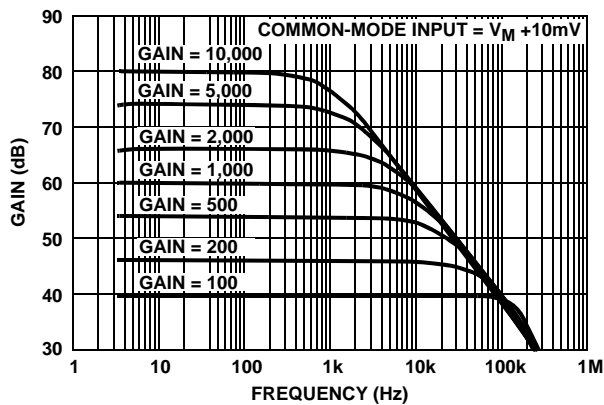

FIGURE 3. AMPLIFIER "A" (IN-AMP) FREQUENCY RESPONSE vs CLOSED LOOP GAIN

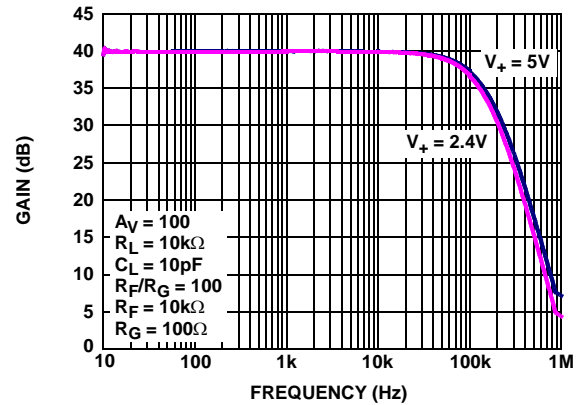

FIGURE 4. AMPLIFIER "A" (IN-AMP) FREQUENCY RESPONSE vs SUPPLY VOLTAGE

**Typical Performance Curves**  $V_+ = +5V$ ,  $V_- = GND$ ,  $V_{CM} = 1/2V_+$ ,  $T_A = +25^\circ C$ , unless otherwise specified. (Continued)

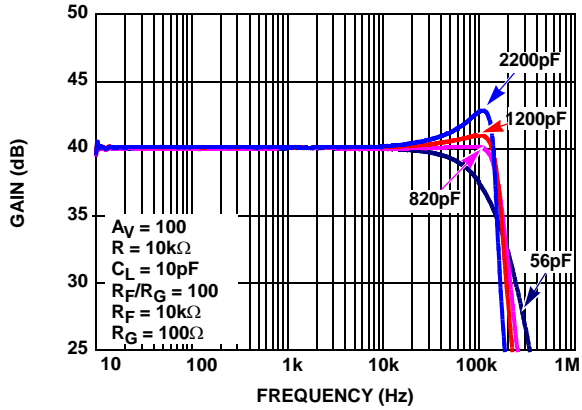

FIGURE 5. AMPLIFIER "A" (IN-AMP) FREQUENCY RESPONSE vs  $C_{LOAD}$

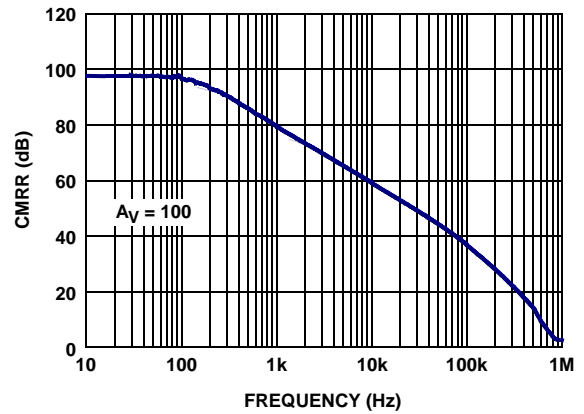

FIGURE 6. AMPLIFIER "A" (IN-AMP) CMRR vs FREQUENCY

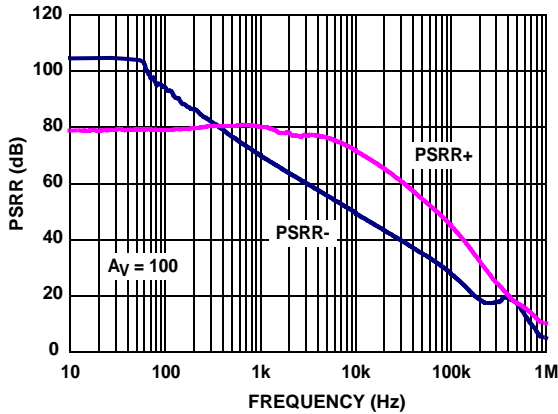

FIGURE 7. AMPLIFIER "A" (IN-AMP) PSRR vs FREQUENCY

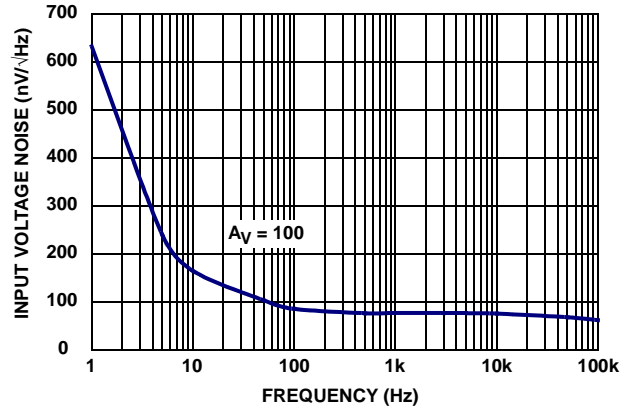

FIGURE 8. AMPLIFIER "A" (IN-AMP) INPUT VOLTAGE NOISE SPECTRAL DENSITY

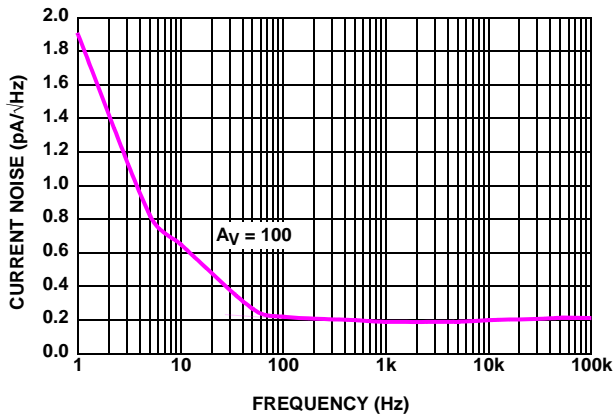

FIGURE 9. AMPLIFIER "A" (IN-AMP) INPUT CURRENT NOISE SPECTRAL DENSITY

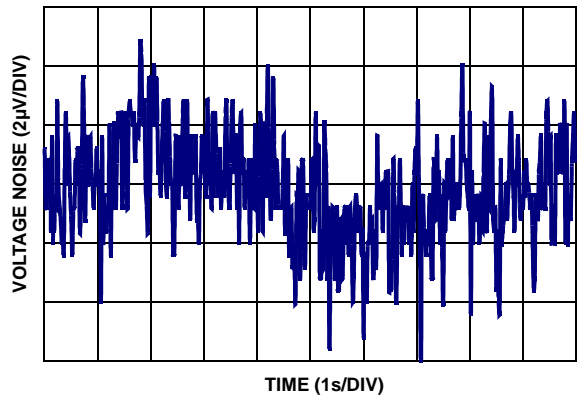

FIGURE 10. AMPLIFIER "A" (IN-AMP) 0.1Hz TO 10Hz INPUT VOLTAGE NOISE

**Typical Performance Curves**  $V_+ = +5V, V_- = GND, V_{CM} = 1/2V_+, T_A = +25^\circ C$ , unless otherwise specified. (Continued)

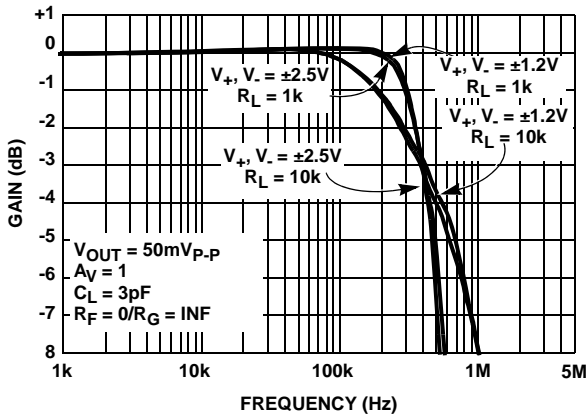

FIGURE 11. AMPLIFIER "B" (OP-AMP) FREQUENCY RESPONSE vs SUPPLY VOLTAGE

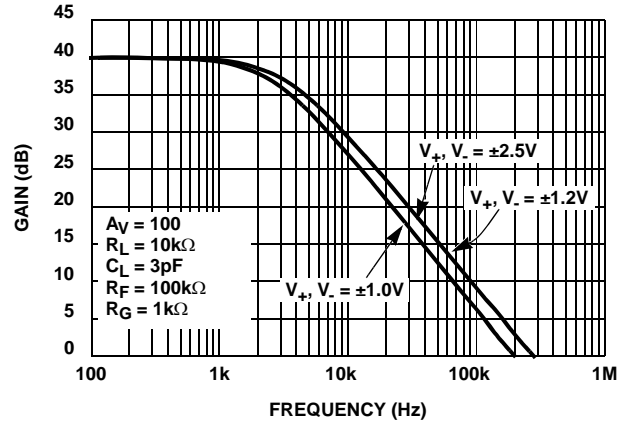

FIGURE 12. AMPLIFIER "B" (OP-AMP) FREQUENCY RESPONSE vs SUPPLY VOLTAGE

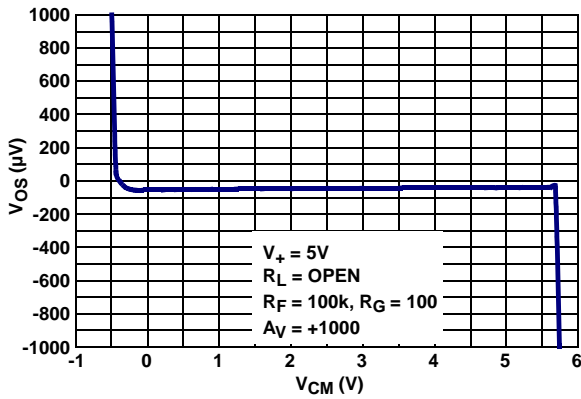

FIGURE 13. INPUT OFFSET VOLTAGE vs COMMON MODE INPUT VOLTAGE

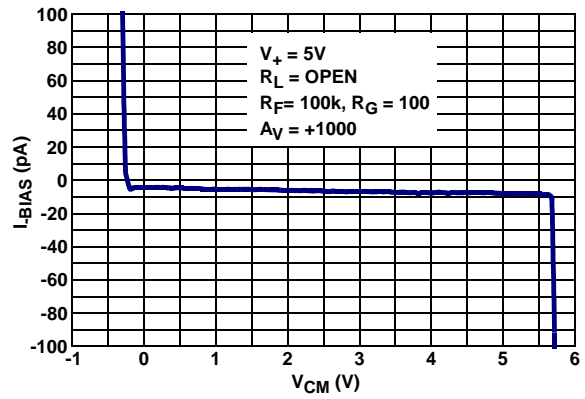

FIGURE 14. INPUT BIAS CURRENT vs COMMON-MODE INPUT VOLTAGE

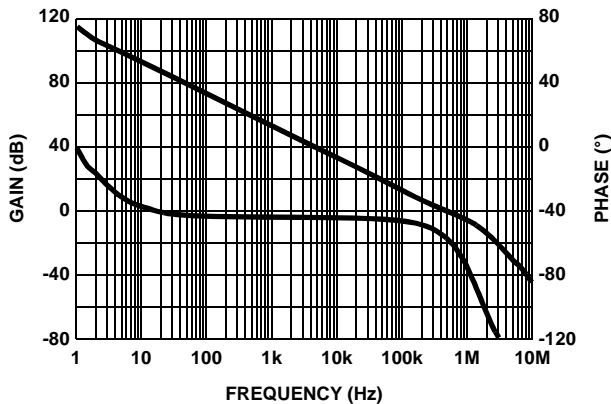

FIGURE 15. AMPLIFIER "B" (OP-AMP)  $A_{VOL}$  vs FREQUENCY @ 100k $\Omega$  LOAD

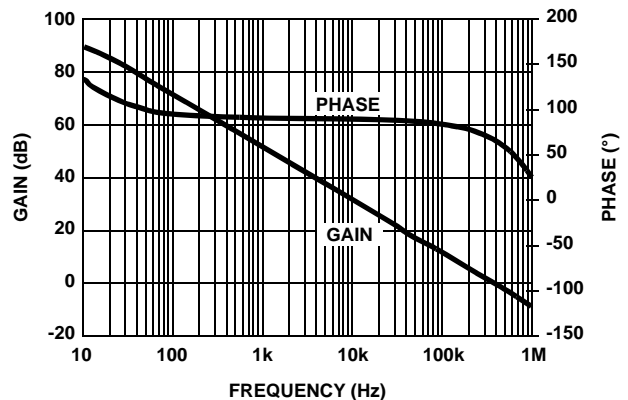

FIGURE 16. AMPLIFIER "B" (OP-AMP)  $A_{VOL}$  vs FREQUENCY @ 1k $\Omega$  LOAD

**Typical Performance Curves**  $V_+ = +5V$ ,  $V_- = GND$ ,  $V_{CM} = 1/2V_+$ ,  $T_A = +25^\circ C$ , unless otherwise specified. (Continued)

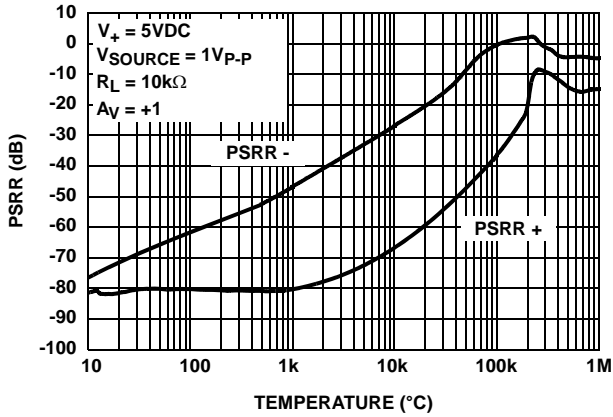

FIGURE 17. AMPLIFIER "B" (OP-AMP) PSRR vs FREQUENCY

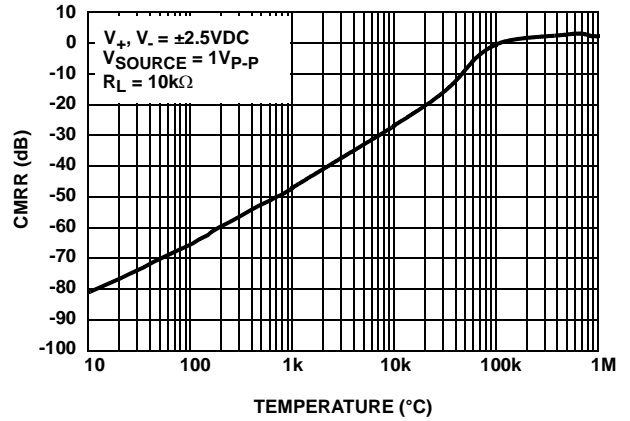

FIGURE 18. AMPLIFIER "B" (OP-AMP) CMRR vs FREQUENCY

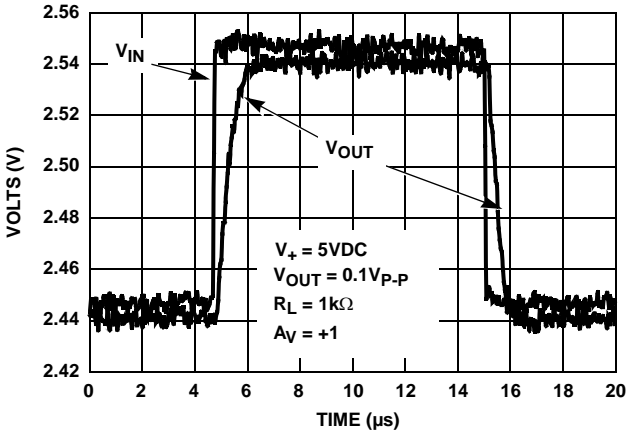

FIGURE 19. AMPLIFIER "B" (OP-AMP) SMALL SIGNAL TRANSIENT RESPONSE

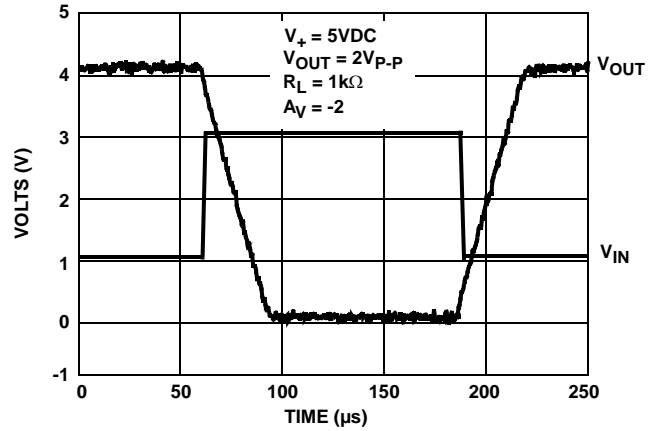

FIGURE 20. AMPLIFIER "B" (OP-AMP) LARGE SIGNAL TRANSIENT RESPONSE

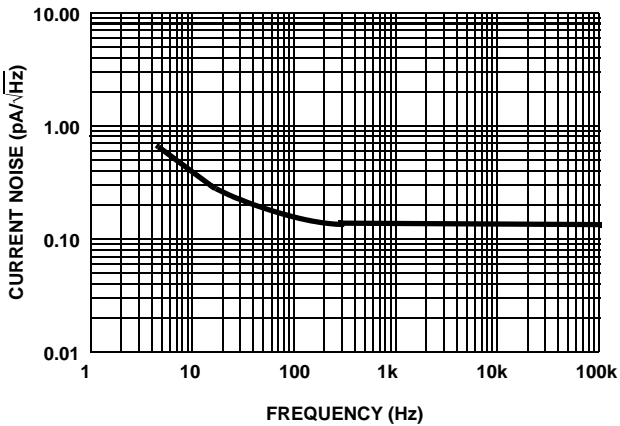

FIGURE 21. AMPLIFIER "B" (OP-AMP) CURRENT NOISE vs FREQUENCY

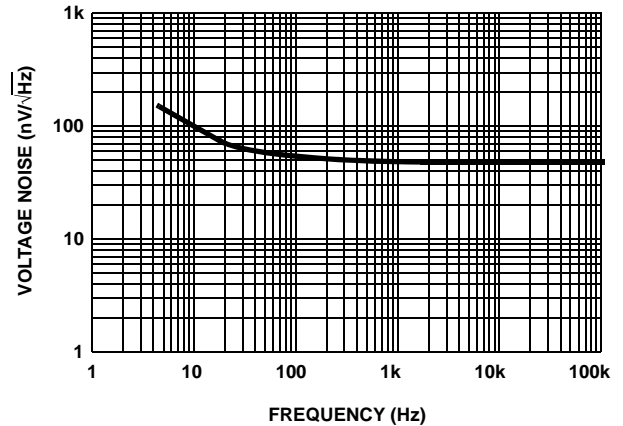

FIGURE 22. AMPLIFIER "B" (OP-AMP) VOLTAGE NOISE vs FREQUENCY



**Typical Performance Curves**  $V_+ = +5V$ ,  $V_- = GND$ ,  $V_{CM} = 1/2V_+$ ,  $T_A = +25^\circ C$ , unless otherwise specified. (Continued)

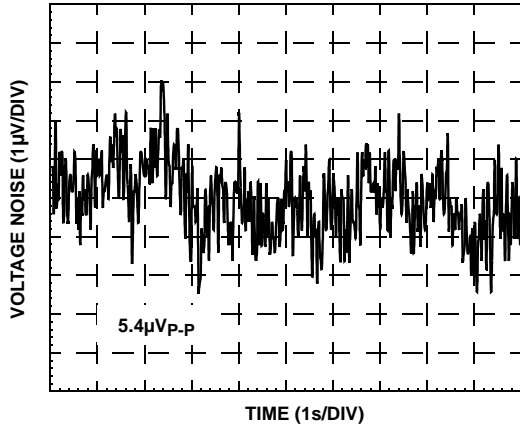

FIGURE 23. AMPLIFIER "B" (OP-AMP) 0.1Hz TO 10Hz INPUT VOLTAGE NOISE

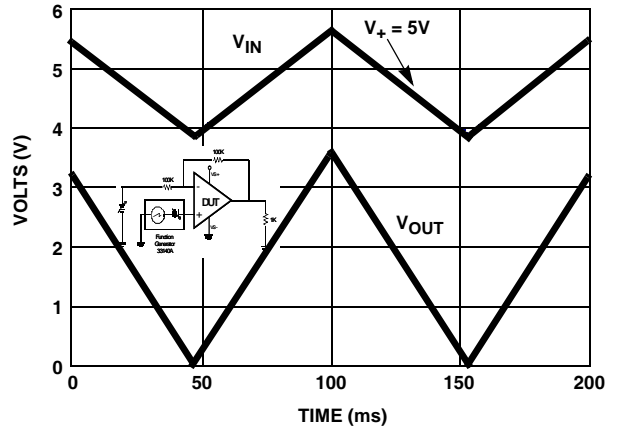

FIGURE 24. AMPLIFIER "B" (OP-AMP) INPUT VOLTAGE SWING ABOVE THE  $V_+$  SUPPLY

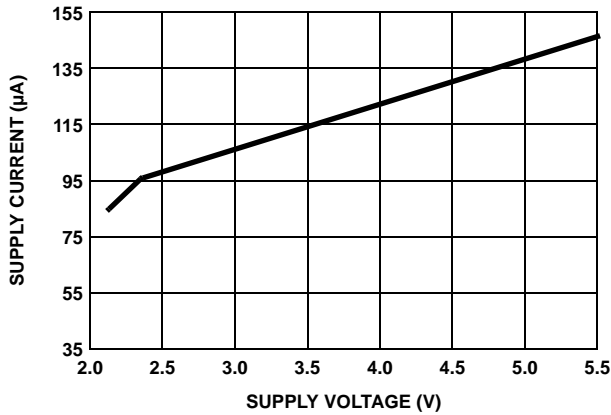

FIGURE 25. SUPPLY CURRENT vs SUPPLY VOLTAGE

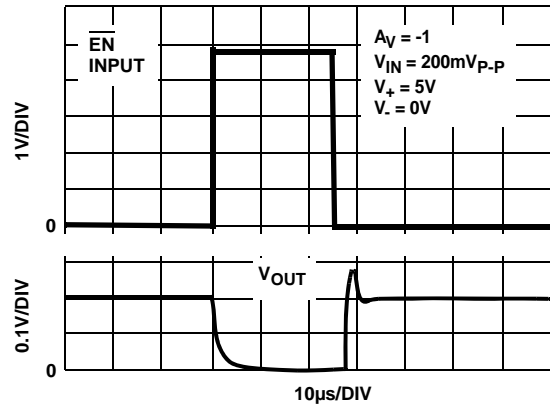

FIGURE 26. AMPLIFIER "B" (OP-AMP) ENABLE TO OUTPUT DELAY TIME

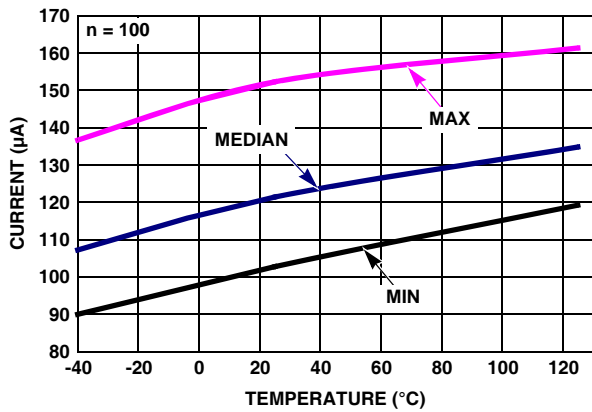

FIGURE 27. TOTAL SUPPLY CURRENT vs TEMPERATURE,  $V_+$ ,  $V_- = \pm 2.5V$  ENABLED,  $R_L = INF$

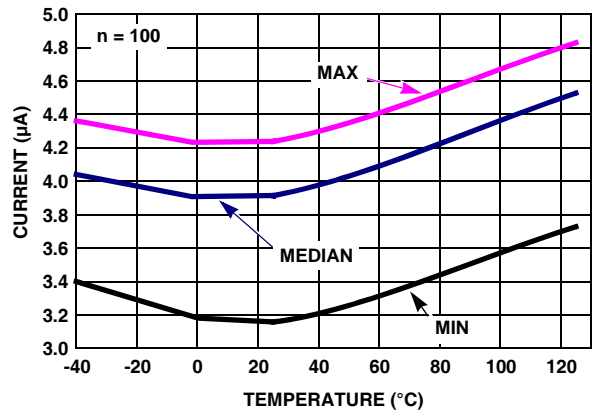

FIGURE 28. DISABLED POSITIVE SUPPLY CURRENT vs TEMPERATURE,  $V_+$ ,  $V_- = \pm 2.5V$ ,  $R_L = INF$

**Typical Performance Curves**  $V_+ = +5V$ ,  $V_- = GND$ ,  $V_{CM} = 1/2V_+$ ,  $T_A = +25^\circ C$ , unless otherwise specified. (Continued)

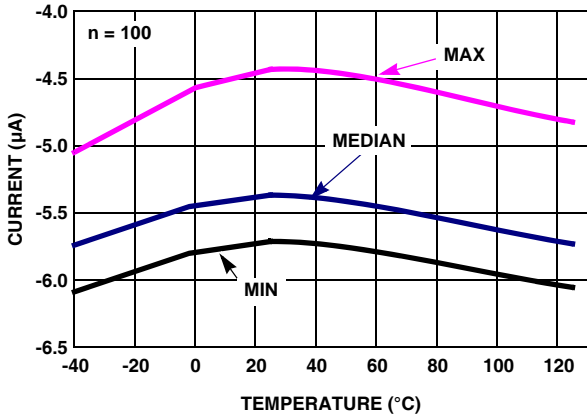

FIGURE 29. DISABLED NEGATIVE SUPPLY CURRENT vs TEMPERATURE,  $V_+$ ,  $V_- = \pm 2.5V$ ,  $R_L = INF$

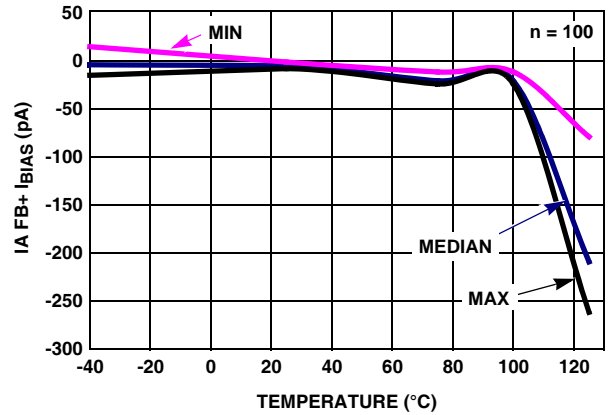

FIGURE 30.  $I_{BIAS}$  (IA FB+) vs TEMPERATURE,  $V_+$ ,  $V_- = \pm 2.5V$

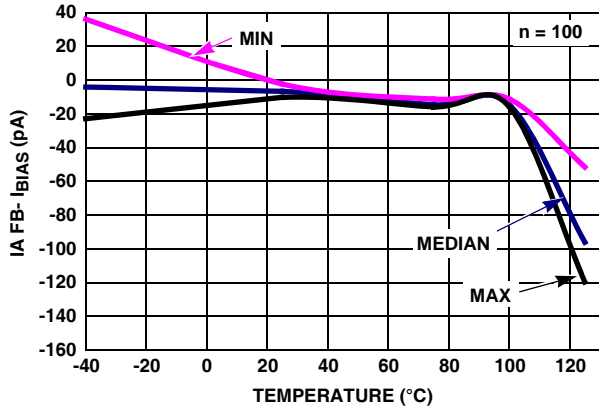

FIGURE 31.  $I_{BIAS}$  (IA FB-) vs TEMPERATURE,  $V_+$ ,  $V_- = \pm 2.5V$ .

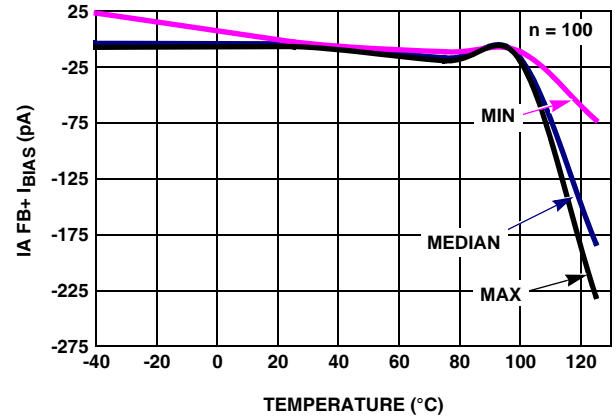

FIGURE 32.  $I_{BIAS}$  (IA FB+) vs TEMPERATURE,  $V_+$ ,  $V_- = \pm 1.2V$

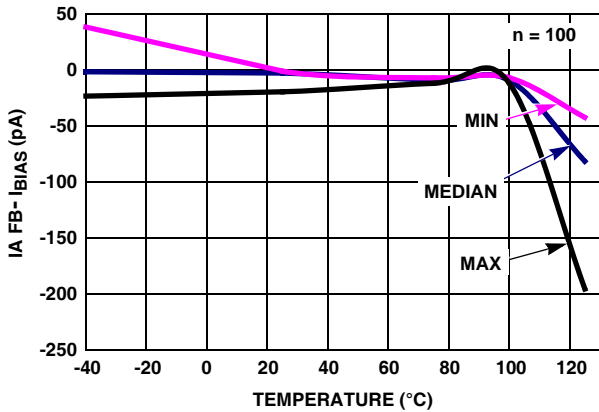

FIGURE 33.  $I_{BIAS}$  (IA FB-) vs TEMPERATURE,  $V_+$ ,  $V_- = \pm 1.2V$

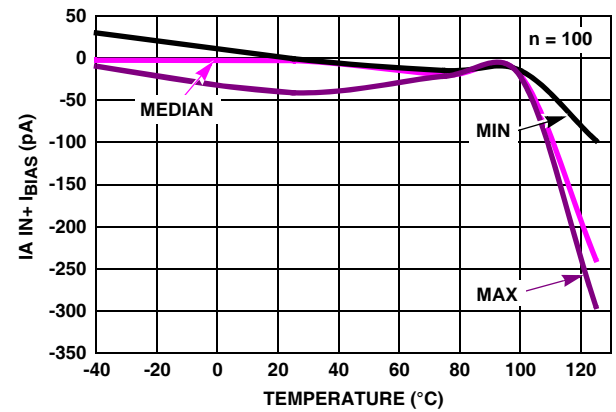

FIGURE 34.  $I_{BIAS}$  (IA IN+) vs TEMPERATURE,  $V_+$ ,  $V_- = \pm 2.5V$

**Typical Performance Curves**  $V_+ = +5V$ ,  $V_- = GND$ ,  $V_{CM} = 1/2V_+$ ,  $T_A = +25^\circ C$ , unless otherwise specified. (Continued)

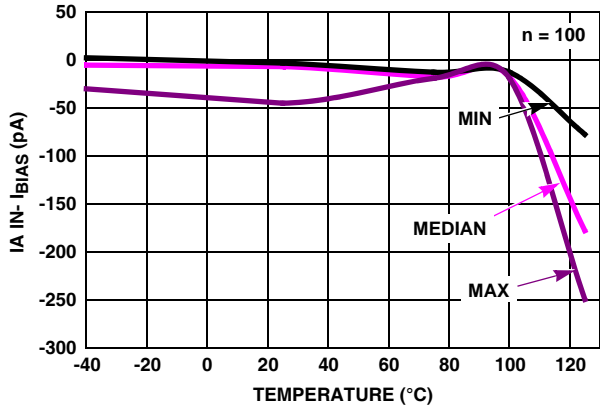

FIGURE 35.  $I_{BIAS}$  (IA IN-) vs TEMPERATURE,  $V_+$ ,  $V_- = \pm 2.5V$

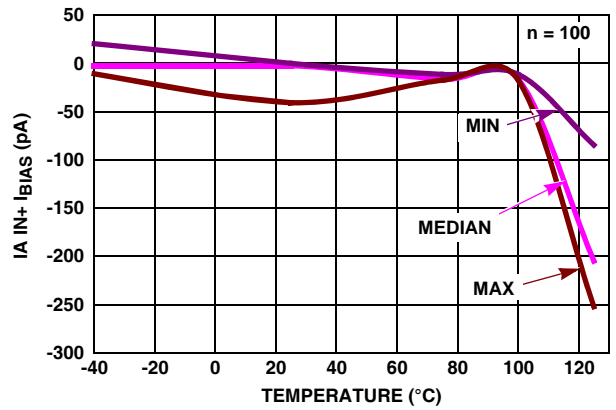

FIGURE 36.  $I_{BIAS}$  (IA IN+) vs TEMPERATURE,  $V_+$ ,  $V_- = \pm 1.2V$

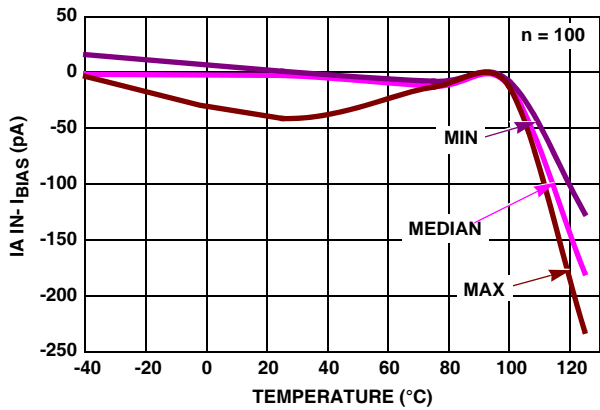

FIGURE 37.  $I_{BIAS}$  (IA IN-) vs TEMPERATURE,  $V_+$ ,  $V_- = \pm 1.2V$

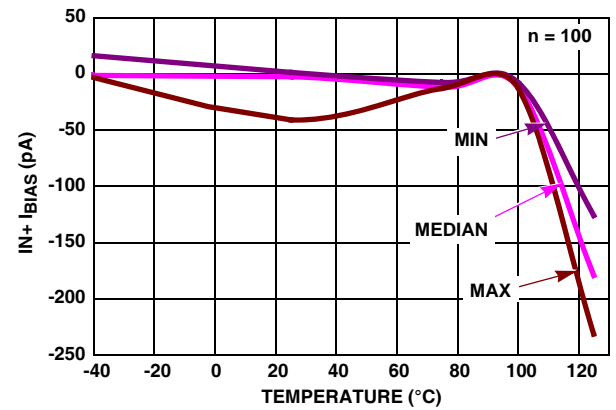

FIGURE 38.  $I_{BIAS}$  (IN+) vs TEMPERATURE,  $V_+$ ,  $V_- = \pm 2.5V$

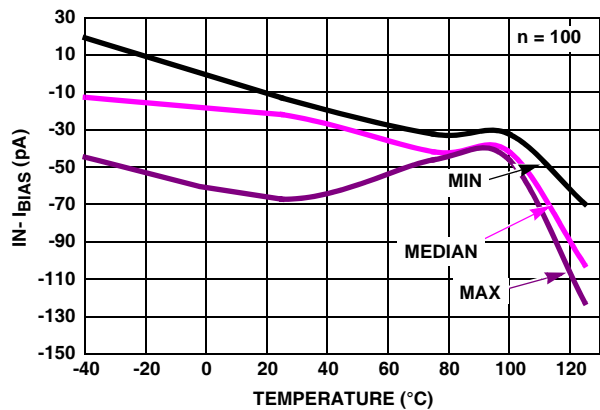

FIGURE 39.  $I_{BIAS}$  (IN-) vs TEMPERATURE,  $V_+$ ,  $V_- = \pm 2.5V$

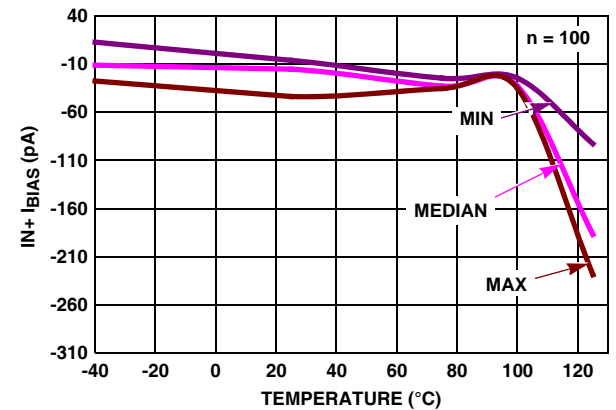

FIGURE 40.  $I_{BIAS}$  (IN+) vs TEMPERATURE,  $V_+$ ,  $V_- = \pm 1.2V$

**Typical Performance Curves**  $V_+ = +5V$ ,  $V_- = GND$ ,  $V_{CM} = 1/2V_+$ ,  $T_A = +25^\circ C$ , unless otherwise specified. (Continued)

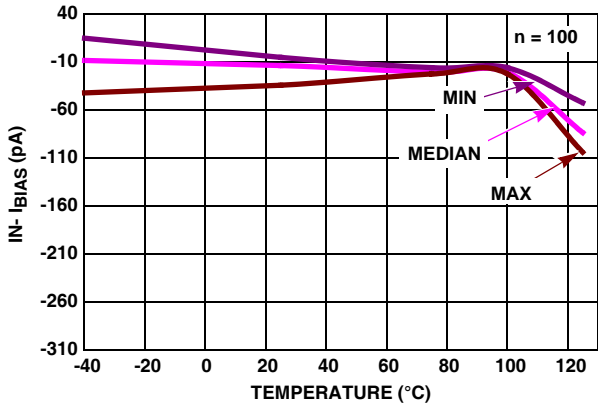

FIGURE 41.  $I_{BIAS} (IN-)$  vs TEMPERATURE,  $V_+, V_- = \pm 1.2V$

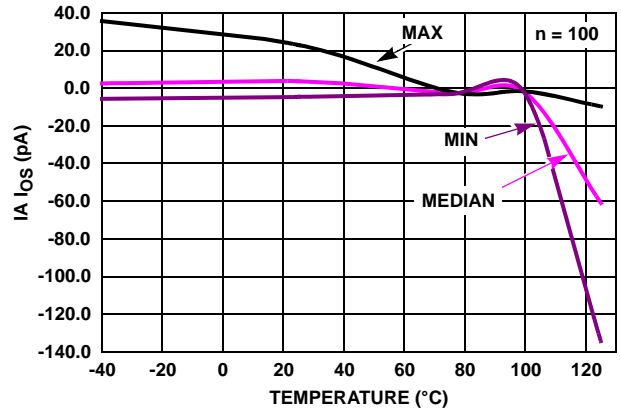

FIGURE 42.  $I_A$  INPUT OFFSET CURRENT vs TEMPERATURE,  $V_+, V_- = \pm 2.5V$

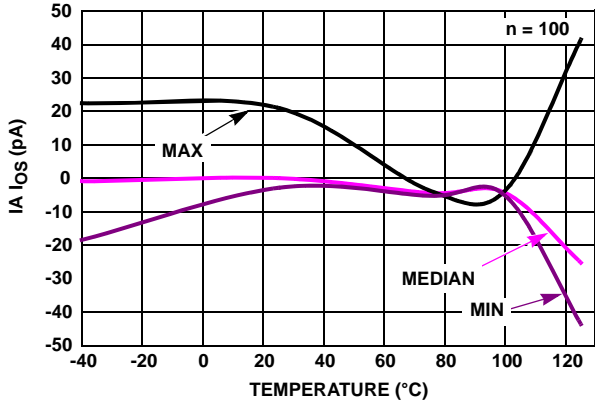

FIGURE 43.  $I_A$  INPUT OFFSET CURRENT vs TEMPERATURE,  $V_+, V_- = \pm 1.2V$

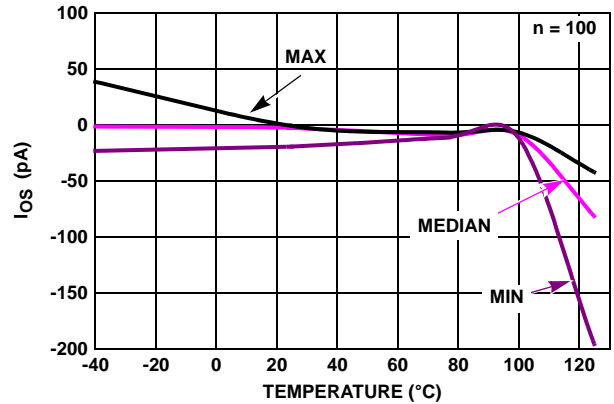

FIGURE 44. INPUT OFFSET CURRENT vs TEMPERATURE,  $V_+, V_- = \pm 2.5V$

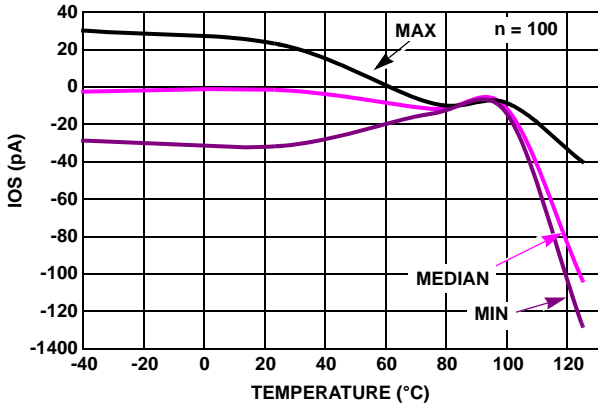

FIGURE 45. INPUT OFFSET CURRENT vs TEMPERATURE,  $V_+, V_- = \pm 1.2V$

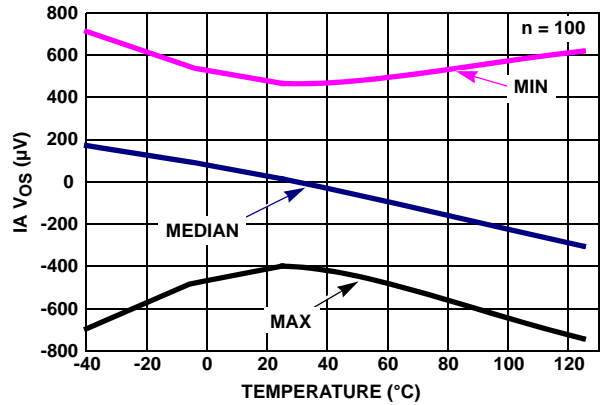

FIGURE 46.  $I_A$  INPUT OFFSET VOLTAGE vs TEMPERATURE,  $V_+, V_- = \pm 2.5V$

**Typical Performance Curves**  $V_+ = +5V$ ,  $V_- = GND$ ,  $V_{CM} = 1/2V_+$ ,  $T_A = +25^\circ C$ , unless otherwise specified. (Continued)

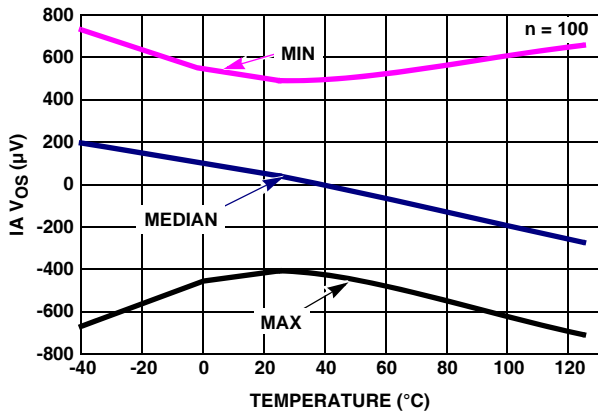

FIGURE 47. IA INPUT OFFSET VOLTAGE vs TEMPERATURE  
 $V_+$ ,  $V_- = \pm 1.2V$

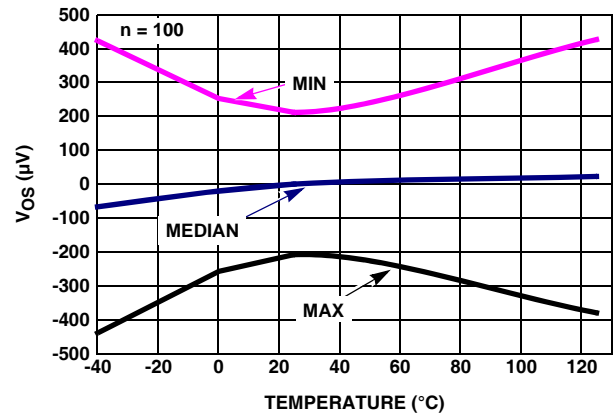

FIGURE 48. INPUT OFFSET VOLTAGE vs TEMPERATURE,  
 $V_+$ ,  $V_- = \pm 2.5V$

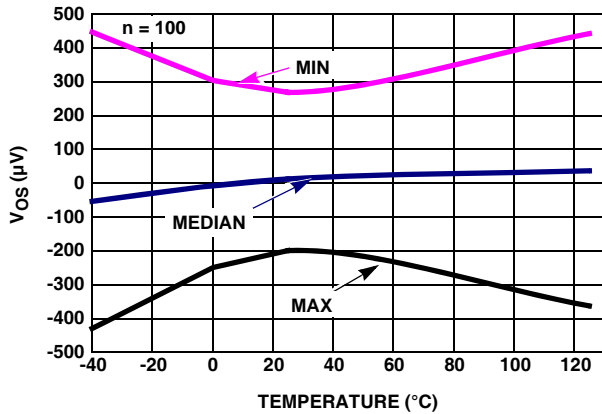

FIGURE 49. INPUT OFFSET VOLTAGE vs TEMPERATURE,  
 $V_+$ ,  $V_- = \pm 1.2V$

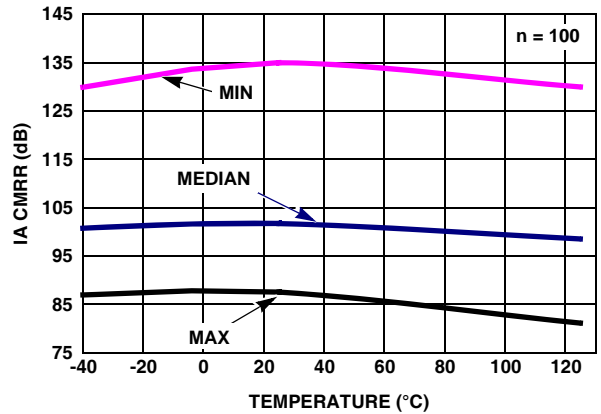

FIGURE 50. IA CMRR vs TEMPERATURE,  $V_{CM} = +2.5V$  TO  $-2.5V$

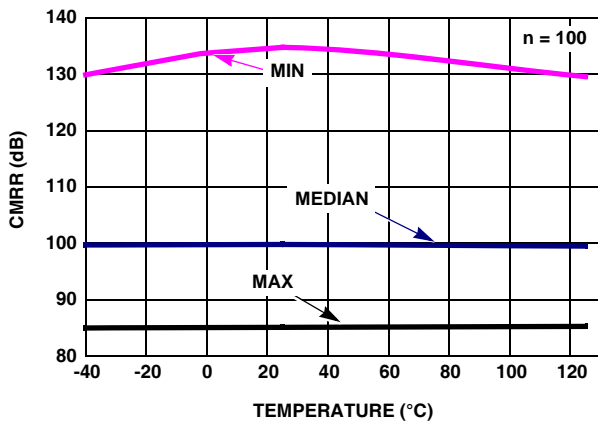

FIGURE 51. CMRR vs TEMPERATURE,  $V_{CM} = +2.5V$  TO  $-2.5V$

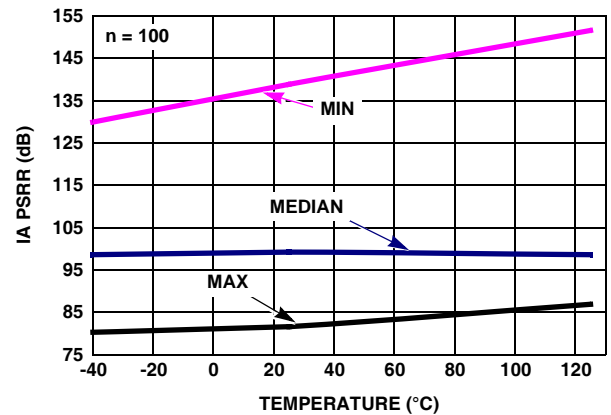

FIGURE 52. IA PSRR vs TEMPERATURE,  $V_+$ ,  $V_- = \pm 2.5V$

**Typical Performance Curves**  $V_+ = +5V$ ,  $V_- = GND$ ,  $V_{CM} = 1/2V_+$ ,  $T_A = +25^\circ C$ , unless otherwise specified. (Continued)

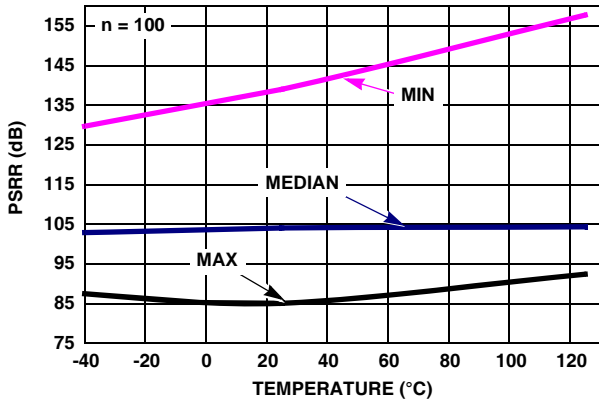

FIGURE 53. PSRR vs TEMPERATURE,  $V_+, V_- = \pm 2.5V$

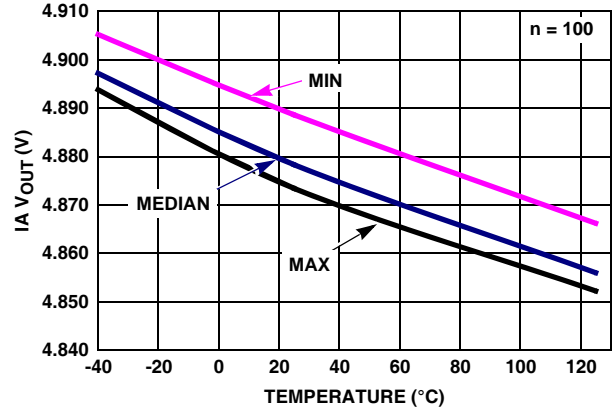

FIGURE 54. IA  $V_{OUT}$  HIGH vs TEMPERATURE,  $R_L = 1k$ ,  $V_+, V_- = \pm 2.5V$

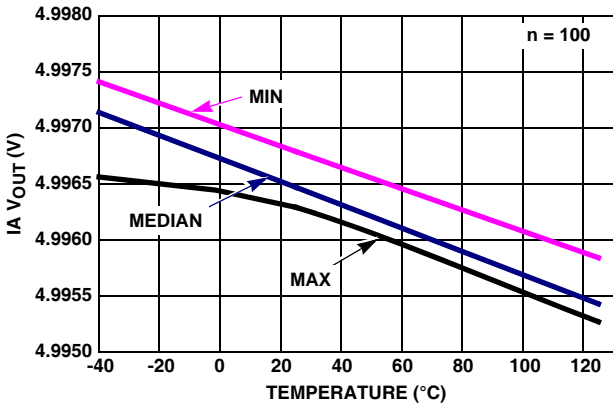

FIGURE 55. IA  $V_{OUT}$  HIGH vs TEMPERATURE,  $R_L = 100k$ ,  $V_+, V_- = \pm 2.5V$

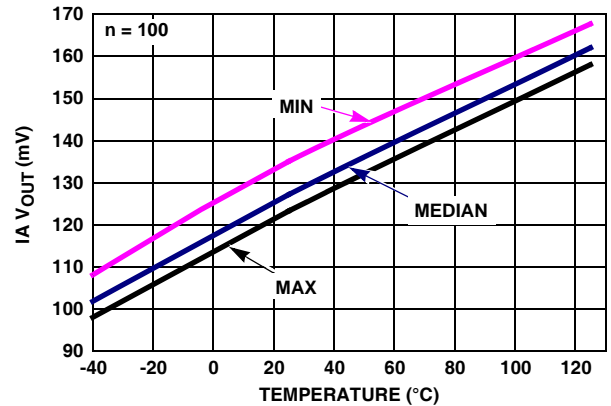

FIGURE 56. IA  $V_{OUT}$  LOW vs TEMPERATURE,  $R_L = 1k$ ,  $V_+, V_- = \pm 2.5V$

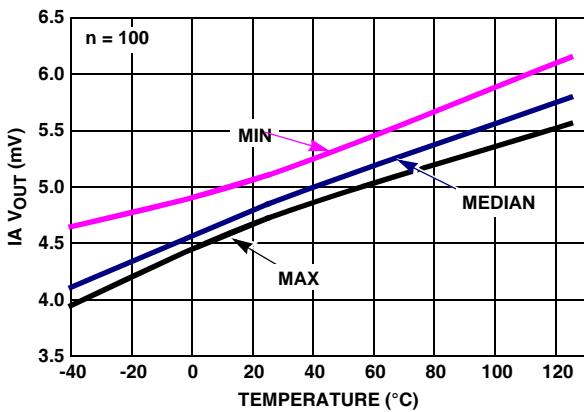

FIGURE 57. IA  $V_{OUT}$  LOW vs TEMPERATURE,  $R_L = 100k$ ,  $V_+, V_- = \pm 2.5V$

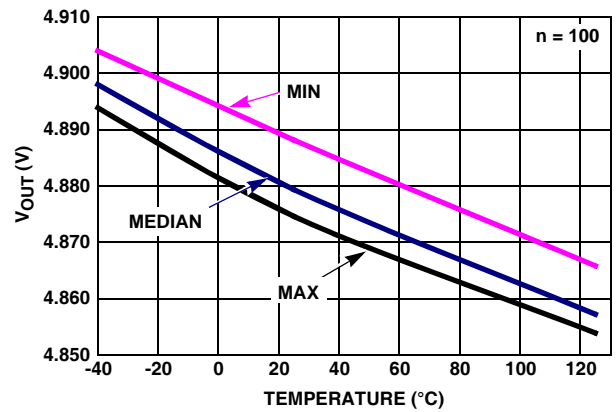

FIGURE 58.  $V_{OUT}$  HIGH vs TEMPERATURE,  $R_L = 1k$ ,  $V_+, V_- = \pm 2.5V$

**Typical Performance Curves**  $V_+ = +5V$ ,  $V_- = GND$ ,  $V_{CM} = 1/2V_+$ ,  $T_A = +25^\circ C$ , unless otherwise specified. (Continued)

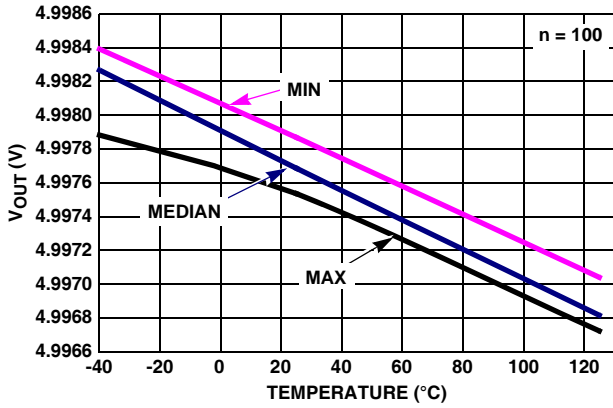

FIGURE 59.  $V_{OUT}$  HIGH vs TEMPERATURE,  $R_L = 100k$ ,  $V_+$ ,  $V_- = \pm 2.5V$

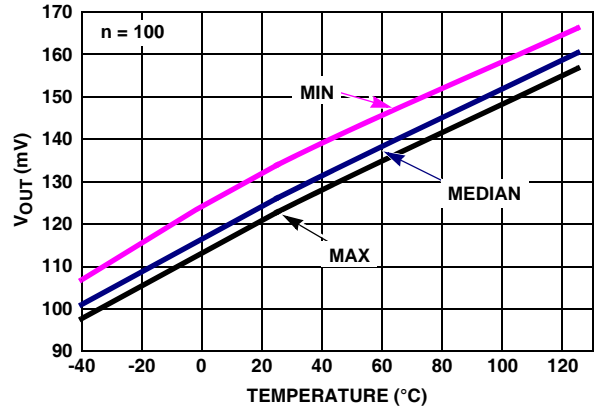

FIGURE 60.  $V_{OUT}$  LOW vs TEMPERATURE,  $R_L = 1k$ ,  $V_+$ ,  $V_- = \pm 2.5V$

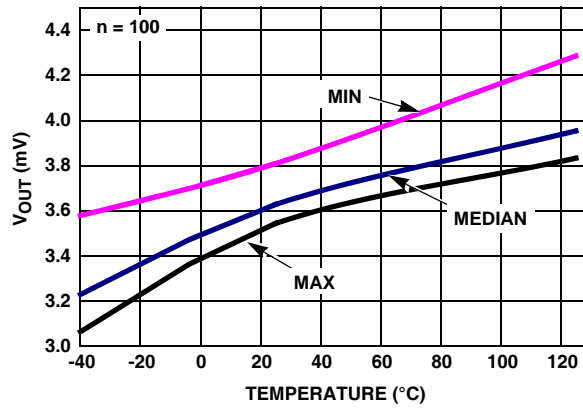
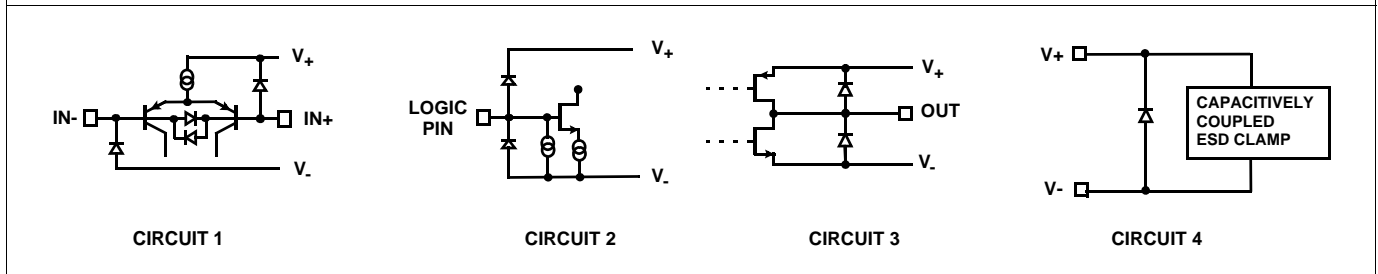

FIGURE 61.  $V_{OUT}$  LOW vs TEMPERATURE  $R_L = 100k$ ,  $V_+$ ,  $V_- = \pm 2.5V$

**Pin Descriptions**

ISL28274 (16 LD QSOP)	ISL28474 (24 LD QSOP)	PIN NAME	EQUIVALENT CIRCUIT	DESCRIPTION
1, 9, 13, 14	11, 14	NC		No internal connection
2	1, 24	IA OUT IA OUT_1 IA OUT_2	Circuit 3	Instrumentation Amplifier output
3	2, 23	IA FB+ IA FB+_1 IA FB+_2	Circuit 1	Instrumentation Amplifier Feedback from non-inverting output
4	3, 22	IA FB- IA FB-_1 IA FB-_2	Circuit 1	Instrumentation Amplifier Feedback from inverting output
5	4, 21	IA IN- IA IN-_1 IA IN-_2	Circuit 1	Instrumentation Amplifier inverting input
6	5, 20	IA IN+ IA IN+_1 IA IN+_2	Circuit 1	Instrumentation Amplifier non-inverting input
7	6, 19	IA EN IA EN_1 IA EN_2	Circuit 2	Instrumentation Amplifier enable pin internal pull-down; Logic "1" selects the disabled state; Logic "0" selects the enabled state.
8	18	V-	Circuit 4	Negative power supply
10	8, 17	EN EN 1 EN 2	Circuit 2	Amplifier enable pin with internal pull-down; Logic "1" selects the disabled state; Logic "0" selects the enabled state.
11	9, 16	IN+ IN+ 1 IN+ 2	Circuit 1	Amplifier non-inverting input
12	10, 15	IN- IN- 1 IN- 2	Circuit 1	Amplifier inverting input
15	12, 13	OUT OUT 1 OUT 2	Circuit 3	Amplifier output
16	7	V+	Circuit 4	Positive power supply

IA = Instrumentation Amplifier



**Description of Operation and Application Information**

**Product Description**

The ISL28274 and ISL28474 provide both a micropower instrumentation amplifier (Amp A) and a low power precision amplifier (Amp B) in the same package. The amplifiers deliver rail-to-rail input amplification and rail-to-rail output swing on a single 2.4V to 5V supply. They also deliver

excellent DC and AC specifications while consuming only 60µA typical supply current per amplifier. Because the instrumentation amplifiers provide an independent pair of feedback terminals to set the gain and to adjust the output level, the in-amp achieves high common-mode rejection ratio regardless of the tolerance of the gain setting resistors. The instrumentation amplifier is internally compensated for a minimum closed loop gain of 100 or greater. An EN pin is used to reduce power consumption, typically 4µA for the



ISL28274 and 8µA for the ISL28474, while both amplifiers are disabled. The user has independent control of each amplifier via separate  $\overline{EN}$  pins.

**Input Protection**

The input and feedback terminals have internal ESD protection diodes to both positive and negative supply rails, limiting the input voltage to within one diode drop beyond the supply rails. If overdriving the inputs is necessary, the external input current must never exceed 5mA. An external series resistor may be used as a protection to limit excessive external voltage and current from damaging the inputs.

**Input Stage and Input Voltage Range**

The input terminals (IN+ and IN-) of both amplifiers “A” and “B” are single differential pair P-MOSFET devices aided by an Input Range Enhancement Circuit to increase the headroom of operation of the common-mode input voltage. The feedback terminals (FB+ and FB-) of amplifier “A” also have a similar topology. As a result, the input common-mode voltage range is rail-to-rail. These amps are able to handle input voltages that are at or slightly beyond the supply and ground making them well suited for single 5V or 3.3V low voltage supply systems. There is no need then to move the common-mode input to achieve symmetrical input voltage.

**Output Stage and Output Voltage Range**

A pair of complementary MOSFET devices drives the output  $V_{OUT}$  to within a few mV of the supply rails. At a 100kΩ load, the PMOS sources current and pulls the output up to 4mV below the positive supply, while the NMOS sinks current and pulls the output down to 3mV above the negative supply, or ground in the case of a single supply operation. The current sinking and sourcing capability of the ISL28274 are internally limited to 31mA.

**Gain Setting of Instrumentation amp “A”**

$V_{IN}$ , the potential difference across IN+ and IN-, is replicated (less the input offset voltage) across FB+ and FB-. The goal of the ISL28274 in-amp is to maintain the differential voltage across FB+ and FB- equal to IN+ and IN-;  $(FB+ - FB-) = (IN+ - IN-)$ . Consequently, the transfer function can be derived. The gain is set by two external resistors, the feedback resistor  $R_F$ , and the gain resistor  $R_G$ .

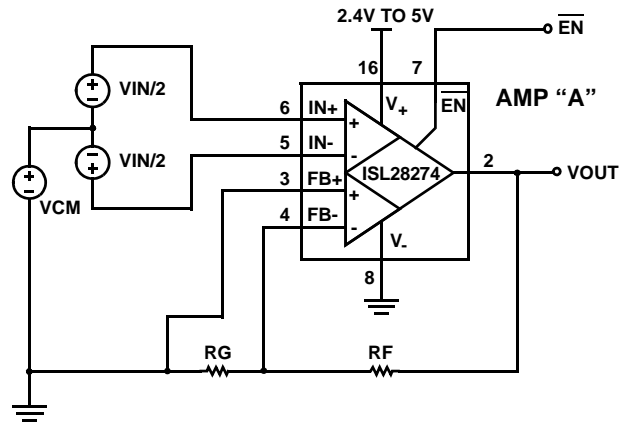

FIGURE 62. GAIN IS BY EXTERNAL RESISTORS  $R_F$  AND  $R_G$

$$V_{OUT} = \left(1 + \frac{R_F}{R_G}\right) V_{IN} \quad (EQ. 1)$$

In Figure 62, the FB+ pin and one end of resistor  $R_G$  are connected to GND. With this configuration, Equation 1 is only true for a positive swing in  $V_{IN}$ ; negative input swings will be ignored and the output will be at ground.

**Reference Connection**

Unlike a three-op amp instrumentation amplifier, a finite series resistance seen at the REF terminal does not degrade the high CMRR performance, eliminating the need for an additional external buffer amplifier. Figure 63 uses the FB+ pin to provide a high impedance REF terminal.

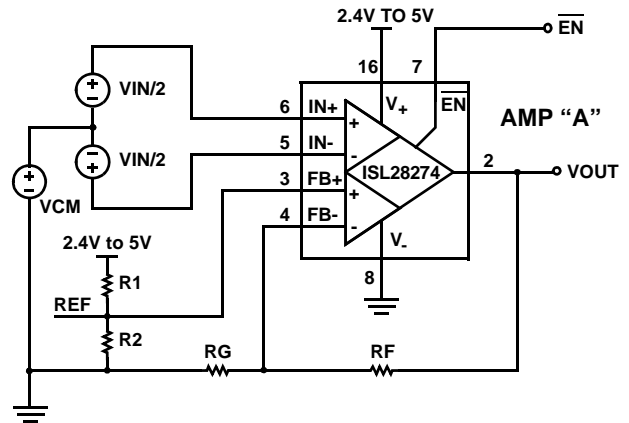

FIGURE 63. GAIN SETTING AND REFERENCE CONNECTION

$$V_{OUT} = \left(1 + \frac{R_F}{R_G}\right) (V_{IN}) + \left(1 + \frac{R_F}{R_G}\right) (V_{REF}) \quad (EQ. 2)$$

The FB+ pin is used as a REF terminal to center or to adjust the output. Because the FB+ pin is a high impedance input, an economical resistor divider can be used to set the voltage at the REF terminal without degrading or affecting the CMRR performance. Any voltage applied to the REF terminal will shift  $V_{OUT}$  by  $V_{REF}$  times the closed loop gain, which is set by resistors  $R_F$  and  $R_G$  as shown in Figure 63.

The FB+ pin can also be connected to the other end of resistor,  $R_G$ . See Figure 64. Keeping the basic concept that the in-amps maintain constant differential voltage across the input terminals and feedback terminals ( $IN+ - IN- = FB+ - FB-$ ), the transfer function of Figure 64 can be derived.

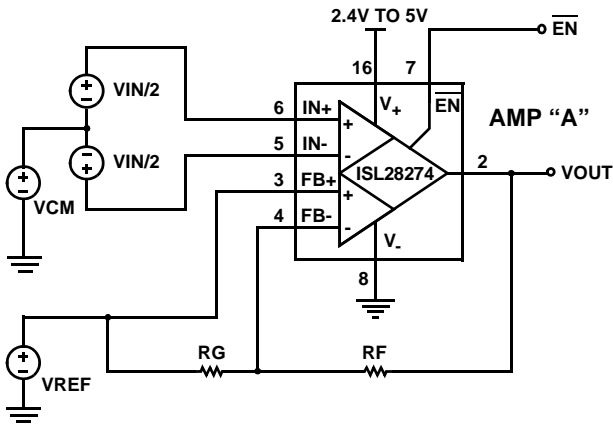

FIGURE 64. REFERENCE CONNECTION WITH AN AVAILABLE VREF

$$V_{OUT} = \left(1 + \frac{R_F}{R_G}\right)(V_{IN}) + (V_{REF}) \quad (\text{EQ. 3})$$

A finite resistance  $R_S$  in series with the  $V_{REF}$  source, adds an output offset of  $V_{IN} \cdot (R_S/R_G)$ . As the series resistance  $R_S$  approaches zero, the gain equation is simplified to Equation 3 for Figure 64.  $V_{OUT}$  is simply shifted by an amount  $V_{REF}$ .

**External Resistor Mismatches**

Because of the independent pair of feedback terminals provided by the ISL28274, the CMRR is not degraded by any resistor mismatches. Hence, unlike a three op amp and especially a two op amp in-amp, the ISL28274 reduces the cost of external components by allowing the use of 1% or more tolerance resistors without sacrificing CMRR performance. The ISL28274 CMRR will be 100dB regardless of the tolerance of the resistors used.

**Disable/Power-Down**

The ISL28274 Amplifiers "A" and "B" can be powered down, reducing the supply current to typically 4µA. When disabled, the output is in a high impedance state. The active low  $\overline{EN}$  bar pin has an internal pull-down and hence, can be left floating and the in-amp and op amp enabled by default. When  $\overline{EN}$  is connected to an external logic, the amplifiers will power down when  $\overline{EN}$  is pulled above 2V, and will power on when  $\overline{EN}$  is pulled below 0.8V.

**Using Only the Instrumentation Amplifier**

If the application only requires the instrumentation amp, the user must configure the unused op amp to prevent it from oscillating. The unused op amp will oscillate if the input and output pins are floating. This will result in higher than expected supply currents and possible noise injection into

the in-amp. The proper way to prevent this oscillation is to short the output to the negative input and ground the positive input (as shown in Figure 65).

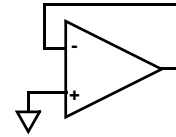

FIGURE 65. PREVENTING OSCILLATIONS IN UNUSED CHANNELS

**Proper Layout Maximizes Performance**

To achieve the maximum performance of the high input impedance and low offset voltage, care should be taken in the circuit board layout. The PC board surface must remain clean and free of moisture to avoid leakage currents between adjacent traces. Surface coating of the circuit board will reduce surface moisture and provide a humidity barrier, reducing parasitic resistance on the board. When input leakage current is a concern, the use of guard rings around the amplifier inputs will further reduce leakage currents. Figure 66 shows a guard ring example for a unity gain amplifier that uses the low impedance amplifier output at the same voltage as the high impedance input to eliminate surface leakage. The guard ring does not need to be a specific width, but it should form a continuous loop around both inputs. For further reduction of leakage currents, components can be mounted to the PC board using PTFE standoff insulators.

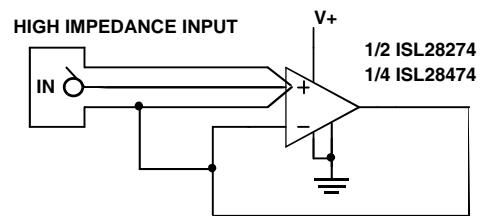

FIGURE 66. GUARD RING EXAMPLE FOR UNITY GAIN AMPLIFIER

**Current Limiting**

The ISL28274 has no internal current-limiting circuitry. If the output is shorted, it is possible to exceed the Absolute Maximum Rating for output current or power dissipation, potentially resulting in the destruction of the device.

**Power Dissipation**

It is possible to exceed the +150°C maximum junction temperatures under certain load and power-supply conditions. It is therefore important to calculate the maximum junction temperature ( $T_{JMAX}$ ) for all applications to determine if power supply voltages, load conditions, or package type need to be modified to remain in the safe operating area. These parameters are related in Equation 4:

$$T_{JMAX} = T_{MAX} + (\theta_{JA} \times PD_{MAXTOTAL}) \quad (EQ. 4)$$

where:

- $PD_{MAXTOTAL}$  is the sum of the maximum power dissipation of each amplifier in the package ( $PD_{MAX}$ )
- $PD_{MAX}$  for each amplifier can be calculated as shown in Equation 5:

$$PD_{MAX} = 2 \times V_S \times I_{SMAX} + (V_S - V_{OUTMAX}) \times \frac{V_{OUTMAX}}{R_L} \quad (EQ. 5)$$

where:

- $T_{MAX}$  = Maximum ambient temperature
- $\theta_{JA}$  = Thermal resistance of the package
- $PD_{MAX}$  = Maximum power dissipation of 1 amplifier
- $V_S$  = Supply voltage (Magnitude of  $V_+$  and  $V_-$ )
- $I_{MAX}$  = Maximum supply current of 1 amplifier
- $V_{OUTMAX}$  = Maximum output voltage swing of the application
- $R_L$  = Load resistance

Quarter Size Outline Plastic Packages Family (QSOP)

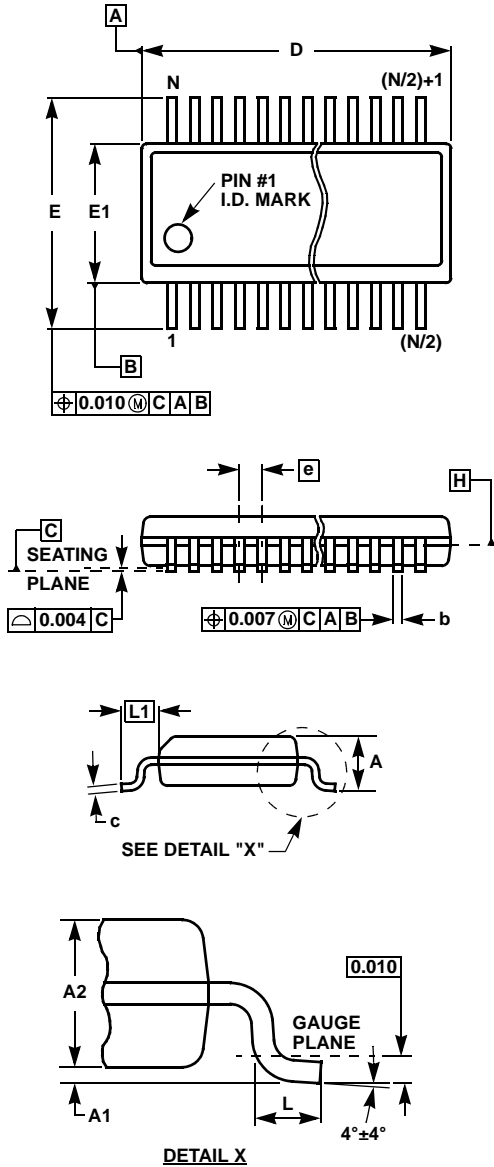

MDP0040

QUARTER SIZE OUTLINE PLASTIC PACKAGES FAMILY

SYMBOL	INCHES			TOLERANCE	NOTES
	QSOP16	QSOP24	QSOP28		
A	0.068	0.068	0.068	Max.	-
A1	0.006	0.006	0.006	±0.002	-
A2	0.056	0.056	0.056	±0.004	-
b	0.010	0.010	0.010	±0.002	-
c	0.008	0.008	0.008	±0.001	-
D	0.193	0.341	0.390	±0.004	1, 3
E	0.236	0.236	0.236	±0.008	-
E1	0.154	0.154	0.154	±0.004	2, 3
e	0.025	0.025	0.025	Basic	-
L	0.025	0.025	0.025	±0.009	-
L1	0.041	0.041	0.041	Basic	-
N	16	24	28	Reference	-

Rev. F 2/07

NOTES:

1. Plastic or metal protrusions of 0.006" maximum per side are not included.
2. Plastic interlead protrusions of 0.010" maximum per side are not included.
3. Dimensions "D" and "E1" are measured at Datum Plane "H".
4. Dimensioning and tolerancing per ASME Y14.5M-1994.

All Intersil U.S. products are manufactured, assembled and tested utilizing ISO9000 quality systems. Intersil Corporation's quality certifications can be viewed at [www.intersil.com/design/quality](http://www.intersil.com/design/quality)

*Intersil products are sold by description only. Intersil Corporation reserves the right to make changes in circuit design, software and/or specifications at any time without notice. Accordingly, the reader is cautioned to verify that data sheets are current before placing orders. Information furnished by Intersil is believed to be accurate and reliable. However, no responsibility is assumed by Intersil or its subsidiaries for its use; nor for any infringements of patents or other rights of third parties which may result from its use. No license is granted by implication or otherwise under any patent or patent rights of Intersil or its subsidiaries.*

For information regarding Intersil Corporation and its products, see [www.intersil.com](http://www.intersil.com)