

TE Connectivity DEUTSCH DTS Series MIL-DTL-38999 Series III Metal Connectors



INTERMATEABLE WITH SOURIAU CONNECTORS AND ALL MIL-DTL-38999 SERIES III

TE DEUTSCH DTS series MIL-DTL-38999 series III metal connectors offer high density contact arrangements in a miniature metal circular connector. DTS connectors meet MIL-38999 and were originally designed as military and aerospace components. The TE DEUTSCH DTS series is now being used in many applications requiring extremely reliable interconnections. These TE DEUTSCH connectors are quick-mating, environmentally-sealed, triple-lead threaded, have a self-locking coupling, and are EMI/RFI-shielded. A variety of D38999 backshells are available. For full product details on the TE DEUTSCH DTS series MIL-DTL-38999 series III metal connectors, please see the specifications below.

APPLICATIONS

- High-performance military aircraft
- Commercial aircraft
- Communications equipment
- Armored personnel carriers & tanks
- High temperature industrial equipment
- Missiles
- Shipboard

FEATURES

- High reliability
- Outstanding EMI/RFI shielding protection
- High density
- Self-locking connector systems
- MIL-DTL-38999
- Scoop-proof contact protection

TECHNICAL
SPECIFICATIONS**MATERIALS AND FINISHES**

Shell	Aluminium alloy or stainless steel
Shell Plating	Electroless Nickel, Olive Drab Chromate over nickel, Black Zinc Nickel, Nickel PTFE
Contacts	Copper alloy
Contact Platings	50u" gold plated
Insulator	Rigid plastic dielectric
Seals	Fluorinated silicone based elastomer

ELECTRICAL DATA

Wire Range Sizes	12-24AWG
Insulation Resistance	5000 Megaohms minimum at 77°F (25°C)

Contact Resistance of mated contacts end to end

CONTACT SIZE	MAXIMUM MILLIVOLT DROP
22D	40
20	35
16	25
12	25

Test Voltage ac rms

SERVICE RATING	SEA LEVEL		100,000 FEET ALTITUDE	
	MATED	UNMATED	MATED	UNMATED
M	1300	1300	800	200
N	1000	1000	600	200
I	1800	1800	1000	200
II	2300	2300	1000	200

Current Rating

WIRE SIZE	CONTACT SIZE	MAX. CURRENT FOR TEST IN AMPS	POTENTIAL DROP MILLIVOLT AT 77°F (25°C)
24	20	3	<45
20	20	7.5	<55
20	16	7.5	<45
16	16	13	<50
14	12	17	<45
12	12	23	<50

MECHANICAL DATA

Operating Temperature	Z - Black Zinc Nickel -65°C to +175°C (-85°F to +347°F) W - Olive drab -65°C to +175°C (-85°F to +347°F) F - Electroless nickel -65°C to +200°C (-85°F to +392°F) K - Stainless steel -65°C to +200°C (-85°F to +392°F) S - Electrodeposited nickel stainless steel -65°C to +200°C (-85°F to +392°F)
Sealing	Against sand, dust per MIL-STD-202 & ice resistance

MECHANICAL DATA

Wire Sealing Range

CONTACT SIZE	MINIMUM		MAXIMUM	
	INCHES	MM	INCHES	MM
22D	0.030	0.76	0.054	1.37
20	0.040	1.02	0.830	2.11
16	0.065	1.65	0.109	2.77
12	0.097	2.46	0.142	3.61
8 (Coax)	0.135	3.43	0.155	3.94
8 (Twinax)	0.124	3.15	0.134	3.40

Insulation Strip Length

CONTACT SIZE	STRIP LENGTH	
	INCHES	MM
22D	0.125	3.18
20	0.188	4.77
16	0.188	4.77
12	0.188	4.77

Mating Life	500 mating cycle
Salt Spray	Z - Black Zinc Nickel, 500 hours per MIL-STD-1344A method 1001 condition C W - Olive Drab, 500 hours per MIL-STD-1344A method 1001 condition C F - Electroless Nickel, 48 hours per MIL-STD-1344A method 1001 condition B K - Stainless Steel, 2000 hours per MIL-STD-1344A method 1001 condition C S - Electrodeposited Nickel Stainless Steel, 2000 hours per MIL-STD-1344A method 1001 condition C
Temp Durability	Z - Black Zinc Nickel -65°C to +175°C (-85°F to +347°F) W - Olive drab -65°C to +175°C (-85°F to +347°F) F - Electroless nickel -65°C to +200°C (-85°F to +392°F) K - Stainless steel -65°C to +200°C (-85°F to +392°F) S - Electrodeposited nickel stainless steel -65°C to +200°C (-85°F to +392°F)
Chemical Resistance	Lubricating oils, hydraulic fluids, coolants, deicing fluids per MIL-STD-1344A Method 1016 condition a-1
Sine Vibration	60g at -55°C per MIL-DTL-38999L 4.5.23.2.1
Random Vibration	49.5 grms at ambient temperatures
Shock	300 grms
EMI Shielding Effectiveness	100 MHz to 10 GHz - minimum attenuation of 50dB
Contact Type	Crimp, fiber optic, coax, twinax, or printed circuit
Number of Circuits	2 to 128
Contact Insertion	Rear Insertion/Rear Extraction with simple plastic or high quality metal hand tools
Polarization	Five keyways with optional master keyway rotations (Note insert and main keyways remain fixed)
Approvals	MIL-DTL-38999

Contact Retention

CONTACT SIZE	RETENTION AXIAL LOAD +/-10 PERCENT		SEPARATION FORCE MINIMUM (INITIAL)	
	NEWTONS	LBS.	NEWTONS	OUNCES
22D	44	10	0.19	0.7
20	15	67	0.19	0.7
16	25	111	0.56	2.0
12	25	111	0.83	3.0
8	25	111	1.39	5.0
8 Twinax	25	111	1.39	5.0

HOW TO ORDER DTS/D38999 SERIES CONNECTORS

1	2	3	4	5	6
D38999/20	F	A35	P	A	-L/C
SHELL STYLE	FINISH	LAYOUT	CONTACT	POLARIZATION	MODIFIER

(Military part number example)

1	2	3	4	5	6
DTS20	F	9-35	P	A	-LC
SHELL STYLE	FINISH	LAYOUT	CONTACT	POLARIZATION (OMIT FOR NORMAL)	MODIFIER

(Commercial part number example)

STEP 1: SELECT SHELL STYLE, PLUG OR RECEPTACLE



STEP 2: SELECT FINISH

- F = Electroless Nickel
- K = Stainless Steel -45dB
- G = Space Grade, Outgassed

- W = Olive Drab Chromate over Cadmium over Electroless Nickel
- S = Stainless Steel / Electroless Nickel -65dB
- Z = Black Zinc Nickel

Available with PC pins. Contact us for more details.

HOW TO ORDER DTS/D38999 SERIES CONNECTORS

STEP 3: SELECT LAYOUT

⇒ See page 66 for listing by # of contacts

MILITARY D38999 LAYOUT	COMMERCIAL DTS LAYOUT	SERVICE RATING	CONTACTS					
			TOTAL NUMBER	22D	20	16	12	8
A35	9-35	M	6	6				
A98	9-98	I	3		3			
-	11-01		1					1
B5	11-5	I	5		5			
-	11-12		1				1	
B35	11-35	M	13	13				
B98	11-98	I	6		6			
B99	11-99	I	7		7			
C4	13-4	I	4			4		
C8	13-8	I	8		8			
C35	13-35	M	22	22				
C98	13-98	I	10		10			
D5	15-5	II	5			5		
D15	15-15	I	15		14	1		
D18	15-18	I	18		18			
D19	15-19	I	19		19			
D35	15-35	M	37	37				
D97	15-97	I	12		8	4		
E6	17-6	I	6				6	
E8	17-8	II	8			8		
E26	17-26	I	26		26			
E35	17-35	M	55	55				
-	17-75	I	2					2
E99	17-99	I	23		21	2		
F11	19-11	II	11			11		
F32	19-32	I	32		32			
F35	19-35	M	66	66				
G11	21-11	I	11				11	
G16	21-16	II	16			16		
G35	21-35	M	79	79				
G39	21-39	I	39		37	2		
G41	21-41	I	41		41			
G75	21-75	N	4					4*
H21	23-21	II	21			21		
H35	23-35	M	100	100				
H53	23-53	I	53		53			
H55	23-55	I	55		55			
J4	25-4	I	56		48	8		
J19	25-19	I	19				19	
J20	25-20	N	30		10	13	4*	3**
J24	25-24	I	24			12	12	
J29	25-29	I	29			29		
J35	25-35	M	128	128				
-	25-36		39		24	10	2	3
-	25-41		46		40	4		2
J46	25-46	I	46		40	4		2*
J61	25-61	I	61		61			

* Coax **Twinax

STEP 4: SELECT CONTACT

- P** = Pin
S = Socket
H = 1500 cycle Pin contacts (military only)
J = 1500 cycle Socket contacts (military only)
Note: See Step 6 if you are not ordering contacts with part.
A = Less Pin Contacts
B = Less Socket Contacts
 May be used for special contact types (PC Pin, Thermocouple, Fibre Optic).
U = PCB Pin contacts (commercial only)
M = PCB socket contacts (commercial only)

STEP 5: SELECT POLARIZATION

- N** = Normal (Standard)
A = Next Most Popular
B = Not Popular
 (limited availability)
C = Check for availability
D = Check for availability
E = Check for availability

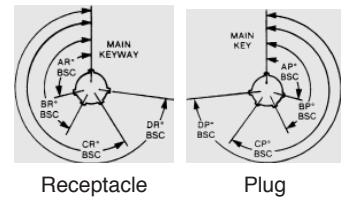

SHELL SIZE	POLARI- ZATION	MINOR KEY LOCATIONS			
		AR & AP	BR & BP	CR & CP	DR & DP
9	N	105	140	215	265
	A	102	132	248	320
	B	80	118	230	312
	C	35	140	205	275
	D	64	155	234	304
11	N	95	141	208	236
	A	113	156	182	292
13	N	80	142	196	293
	A	135	170	200	310
	B	90	145	195	252
	C	53	156	220	255
15	D	119	146	176	298
	E	51	141	184	242
	N	80	142	196	293
17	A	135	170	200	310
	B	49	169	200	244
	C	66	140	200	257
	D	62	145	180	280
	E	79	153	197	272
19	N	80	142	196	293
21	N	80	142	196	293
23	A	135	170	200	310
	B	49	169	200	244
	C	66	140	200	257
	D	62	145	180	280
	E	79	153	197	272
25	N	80	142	196	293
	A	135	170	200	310
	B	49	169	200	244
	C	66	140	200	257
	D	62	145	180	280

STEP 6: SELECT MODIFIER

For other commercial modification, i.e., less tools, with pc contact or with endbell, call.

Omit for standard contacts
-LC = for use with standard contacts, but supplied without contacts, seal plugs or tools (PO must state Less Contacts)
Note: -LC is not marked on part

LAYOUTS BY NUMBER OF CONTACTS

•=22 ○=20 ○=16 ⊕=12 ⊕=8

LAYOUT	09-35	09-98	11-01*	11-05	11-12*	11-35	11-98
# OF CONTACTS	6 - #22	3 - #20	1 - #8	5 - #20	1 - #12	13 - #22	6 - #20
SERVICE RATING	M	I		I		M	I
LAYOUT	11-99	13-04	13-08	13-35	13-98	15-05	15-15*
# OF CONTACTS	7 - #20	4 - #16	8 - #20	22 - #22	10 - #20	5 - #16	14 - #20, 1 - #16
SERVICE RATING	I	I	I	M	I	II	I
LAYOUT	15-18	15-19	15-35	15-97*	17-06	17-08*	17-26
# OF CONTACTS	18 - #20	19 - #20	37 - #22	8 - #20, 4 - #16	6 - #12	8 - #16	26 - #20
SERVICE RATING	I	I	M	I	I	II	I
LAYOUT	17-35	17-75*	17-99*	19-11*	19-32	19-35	21-11*
# OF CONTACTS	55 - #22	2 - #8	21 - #20, 2 - #16	11 - #16	32 - #20	66 - #22	11 - #12
SERVICE RATING	M	I	I	II	I	M	I
LAYOUT	21-16	21-35	21-39	21-41	21-75*	23-21*	23-21*
# OF CONTACTS	16 - #16	79 - #22	2 - #16, 37 - #20	41 - #20	4 - #8	21 - #16	21 - #16
SERVICE RATING	II	M	I	I	N	II	II
LAYOUT	23-35*	23-53	23-55*	25-04*	25-19*	25-20*	25-20*
# OF CONTACTS	100 - #22	53 - #20	55 - #20	48 - #20, 8 - #16	19 - #12	10 - #20, 13 - #16, 4 - #12, 3 - #8	10 - #20, 13 - #16, 4 - #12, 3 - #8
SERVICE RATING	M	I	I	I	I	N	N

CONTACTS

PINS

CONTACT SIZE	WIRE CRIMP SIZE RANGE	PIN PART NUMBER	COLOR BANDS			WIRE STRIP LENGTHS		WIRE INSULATION SEALING RANGE				WIRE HOLE FILLER	WIRE HOLE FILLER COLOR
			1	2	3	IN.	MM	MIN. IN.	MIN. MM	MAX. IN.	MAX. MM		
22D	28,26,24,22	M39029/58-360	Orange	Blue	Black	0.125	3.18	0.030	0.760	0.054	1.37	MS27488-22-2	Black
20	24,22,20	M39029/58-363	Orange	Blue	Orange	0.188	4.77	0.040	1.020	0.083	2.11	MS27488-20-2	Red
16	20,18,16	M39029/58-364	Orange	Blue	Yellow	0.188	4.77	0.065	1.65	0.109	2.77	MS27488-16-2	Blue
12	14,12	M39029/58-365	Orange	Blue	Green	0.188	4.77	0.097	2.46	0.142	3.61	MS27488-12-2	Yellow

SOCKETS

CONTACT SIZE	WIRE CRIMP SIZE RANGE	SOCKET PART NUMBER	COLOR BANDS			WIRE STRIP LENGTHS		WIRE INSULATION SEALING RANGE				WIRE HOLE FILLER	WIRE HOLE FILLER COLOR
			1	2	3	IN.	MM	MIN. IN.	MIN. MM	MAX. IN.	MAX. MM		
22D	28,26,24,22	M39029/56-348	Orange	Yellow	Gray	0.125	3.18	0.030	0.760	0.054	1.37	MS27488-22-2	Black
20	24,22,20	M39029/56-351	Orange	Green	Brown	0.188	4.77	0.040	1.020	0.083	2.11	MS27488-20-2	Red
16	20,18,16	M39029/56-352	Orange	Green	Red	0.188	4.77	0.065	1.65	0.109	2.77	MS27488-16-2	Blue
12	14,12	M39029/56-353	Orange	Green	Orange	0.188	4.77	0.097	2.46	0.142	3.61	MS27488-12-2	Yellow

CONTACT TOOLS

PINS

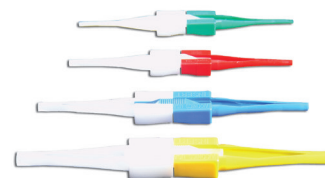

CONTACT SIZE	HAND CRIMP TOOL	TURRET HEAD (LOCATOR)	TURRET HEAD (LOCATOR) COLOR	POWER CRIMP TOOL	POWER TOOL LOCATOR	METAL		PLASTIC		
						INSERTION TOOL	EXTRACTION TOOL	INSERTION/ EXTRACTION TOOL	INSERTION TIP COLOR	EXTRACTION TIP COLOR
22D	M22520/2-01	M22520/2-09	-	WA22	M22520/2-09	MS27495A22M	MS27495A22M	M81969/14-01	Green	White
20	M22520/1-01	M22520/1-04	Red	WA27F	M22520/1-04	MS27495A20	MS27495A20	M81969/14-10	Red	Orange
16	M22520/1-01	M22520/1-04	Blue	WA27F	M22520/1-04	MS27495A16	MS27495A16	M81969/14-03	Blue	White
12	M22520/1-01	M22520/1-04	Yellow	WA27F	M22520/1-04	DAK95-12B	DRK95-12B	M81969/14-04	Yellow	White

SOCKETS

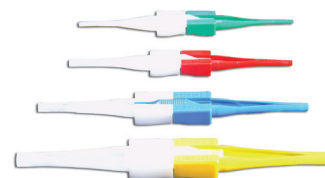

CONTACT SIZE	HAND CRIMP TOOL	TURRET HEAD (LOCATOR)	TURRET HEAD (LOCATOR) COLOR	POWER CRIMP TOOL	POWER TOOL LOCATOR	METAL		PLASTIC		
						INSERTION TOOL	EXTRACTION TOOL	INSERTION/ EXTRACTION TOOL	INSERTION TIP COLOR	EXTRACTION TIP COLOR
22D	M22520/2-01	M22520/2-09	-	WA22	M22520/2-09	MS27495A22M	MS27495A22M	M81969/14-01	Green	White
20	M22520/1-01	M22520/1-04	Red	WA27F	M22520/1-04	MS27495A20	MS27495A20	M81969/14-10	Red	Orange
16	M22520/1-01	M22520/1-04	Blue	WA27F	M22520/1-04	MS27495A16	MS27495A16	M81969/14-03	Blue	White
12	M22520/1-01	M22520/1-04	Yellow	WA27F	M22520/1-04	DAK95-12B	DRK95-12B	M81969/14-04	Yellow	White

DIMENSIONS

TYPE 26 PLUG

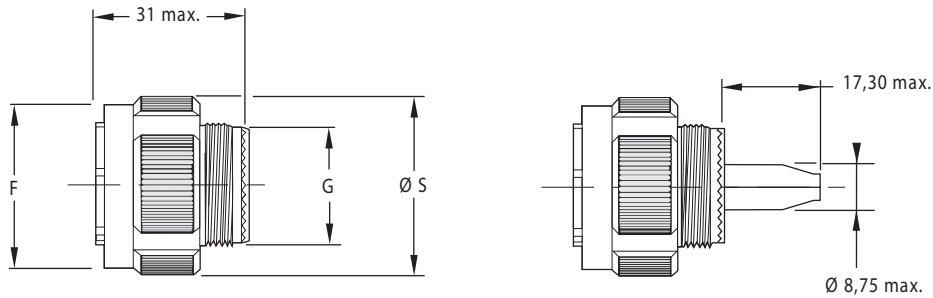

SHELL SIZE	F +.008/-0 (+0.2/-0)	G +/- .004 (+/-0.1)	S MAX.	REAR METRIC THREAD (PLATED)	MASS MAX.*
A/9	.720 (18.4)	.470 (11.9)	.860 (21.8)	M12x1.0-6g 0.100R	15.00 g
B/11	.830 (21.1)	.590 (14.9)	.980 (25.0)	M15x1.0-6g 0.100R	20.00 g
C/13	1.00 (25.4)	.700 (17.9)	1.16 (29.4)	M18x1.0-6g 0.100R	31.00 g
D/15	1.13 (28.7)	.860 (21.9)	1.28 (32.5)	M22x1.0-6g 0.100R	42.00 g
E/17	1.27 (32.2)	.980 (24.9)	1.41 (35.7)	M25x1.0-6g 0.100R	55.00 g
F/19	1.37 (34.9)	1.10 (27.9)	1.52 (38.5)	M28x1.0-6g 0.100R	63.00 g
G/21	1.50 (38.1)	1.22 (30.9)	1.64 (41.7)	M31x1.0-6g 0.100R	79.00 g
H/23	1.62 (41.1)	1.33 (33.9)	1.77 (44.9)	M34x1.0-6g 0.100R	88.00 g
J/25	1.74 (44.3)	1.45 (36.9)	1.89 (48.0)	M37x1.0-6g 0.100R	109.00 g

TYPE 20 SQUARE FLANGE

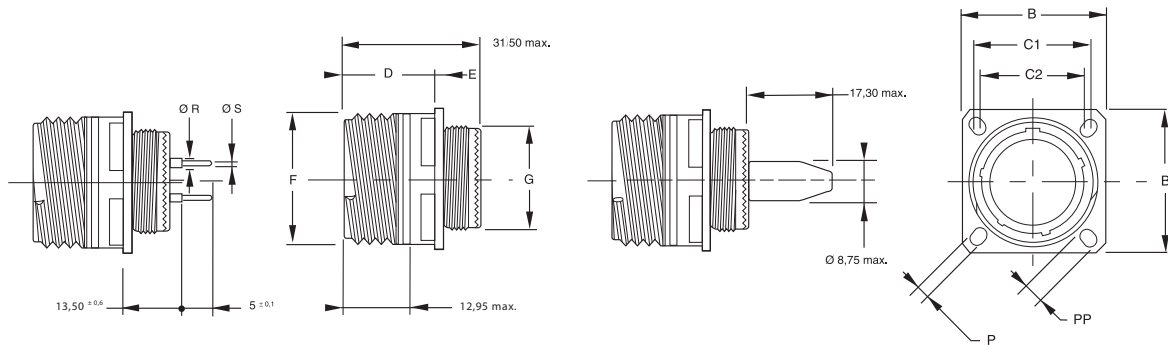

SHELL SIZE	B +/- .012 (+/-0.3)	C1	C2	D MAX.	E +.000 / -.016 (+0 / -0.4)	F +/- .004 (+/-0.1)	G +/- .004 (+/-0.1)	P +/- .008 (+/-0.2)	PP +/- .008 (+/-0.2)	REAR METRIC THREAD (PLATED)	MASS MAX.*
A/9	0.94 (23.80)	0.72 (18.26)	0.59 (15.09)	0.82 (20.90)	.008/.100 (2.10/2.50)	.620 (15.75)	.470 (11.90)	.130 (3.25)	.220 (5.49)	M12x1.0-6g 0.100R	10.00 g
B/11	1.03 (26.20)	0.81 (20.62)	0.72 (18.26)	0.82 (20.90)	.008/.100 (2.10/2.50)	.740 (18.90)	.590 (14.90)	.130 (3.25)	.190 (4.93)	M15x1.0-6g 0.100R	16.00 g
C/13	1.13 (28.60)	0.91 (23.01)	0.81 (20.62)	0.82 (20.90)	.008/.100 (2.10/2.50)	.870 (22.10)	.700 (17.90)	.130 (3.25)	.190 (4.93)	M18x1.0-6g 0.100R	22.00 g
D/15	1.22 (31.00)	0.97 (24.61)	0.91 (23.01)	0.82 (20.90)	.008/.100 (2.10/2.50)	.990 (25.25)	.860 (21.90)	.130 (3.25)	.190 (4.93)	M22x1.0-6g 0.100R	31.00 g
E/17	1.31 (33.30)	1.06 (26.97)	0.97 (24.61)	0.82 (20.90)	.008/.100 (2.10/2.50)	1.18 (29.95)	.980 (24.90)	.130 (3.25)	.190 (4.93)	M25x1.0-6g 0.100R	46.00 g
F/19	1.44 (36.50)	1.16 (29.36)	1.06 (26.97)	0.82 (20.90)	.008/.100 (2.10/2.50)	1.24 (31.55)	1.10 (27.90)	.130 (3.25)	.190 (4.93)	M28x1.0-6g 0.100R	51.00 g
G/21	1.56 (39.70)	1.25 (31.75)	1.16 (29.36)	0.79 (20.10)	.008/.130 (2.10/3.20)	1.37 (34.70)	1.22 (30.90)	.130 (3.25)	.190 (4.93)	M31x1.0-6g 0.100R	65.00 g
H/23	1.69 (42.90)	1.38 (34.93)	1.25 (31.75)	0.79 (20.10)	.008/.130 (2.10/3.20)	1.49 (37.90)	1.33 (33.90)	.150 (3.91)	.240 (6.15)	M34x1.0-6g 0.100R	78.00 g
J/25	1.81 (46.00)	1.50 (38.10)	1.38 (34.93)	.79 (20.10)	.008/.130 (2.10/3.20)	1.62 (41.10)	1.45 (36.90)	.150 (3.91)	.240 (6.15)	M37x1.0-6g 0.100R	97.00 g

All dimensions in inches (millimeters in parenthesis)

DIMENSIONS

TYPE 24 JAM-NUT

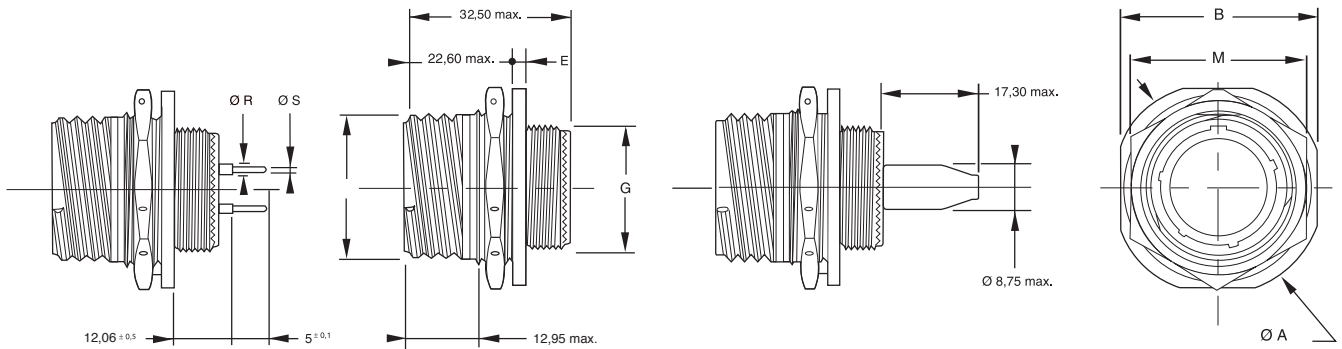

SHELL SIZE	A +/- .012 (+/-0.3)	B +/- .016 (+/-0.4)	E +.004/-.028 (+0.1/-0.7)	F +/- .004 (+/-0.1)	G +/- .004 (+/-0.1)	M MIN./MAX.	REAR METRIC THREAD (PLATED)	MASS MAX.W*
A/9	1.19 (30.20)	1.06 (27.00)	.09 (2.20)	.62 (15.75)	.47 (11.90)	.86/.94 (21.82/24.00)	M12x1.0-6g 0.100R	16.00 g
B/11	1.37 (34.90)	1.25 (31.80)	.09 (2.20)	.74 (18.90)	.59 (14.90)	.98/1.06 (24.99/27.00)	M15x1.0-6g 0.100R	23.00 g
C/13	1.50 (38.10)	1.37 (34.90)	.09 (2.20)	.87 (22.10)	.70 (17.90)	1.17/1.26 (29.77/32.00)	M18x1.0-6g 0.100R	31.00 g
D/15	1.63 (41.30)	1.50 (38.10)	.09 (2.20)	.99 (25.25)	.86 (21.90)	1.30/1.42 (32.91/36.00)	M22x1.0-6g 0.100R	48.00 g
E/17	1.75 (44.50)	1.63 (41.30)	.09 (2.20)	1.18 (29.95)	.98 (24.90)	1.42/1.46 (36.12/37.00)	M25x1.0-6g 0.100R	55.00 g
F/19	1.94 (49.20)	1.81 (46.00)	.12 (3.00)	1.24 (31.55)	1.10 (27.90)	1.55/1.61 (39.25/41.00)	M28x1.0-6g 0.100R	67.00 g
G/21	2.06 (52.40)	1.94 (49.20)	.12 (3.00)	1.37 (34.70)	1.22 (30.90)	1.67/1.81 (42.47/46.00)	M31x1.0-6g 0.100R	81.00 g
H/23	2.19 (55.60)	2.06 (52.40)	.12 (3.00)	1.49 (37.90)	1.33 (33.90)	1.80/1.97 (45.61/50.00)	M34x1.0-6g 0.100R	93.00 g
J/25	2.31 (58.70)	2.19 (55.60)	.12 (3.00)	1.62 (41.10)	1.45 (36.90)	1.94/2.02 (49.25/51.23)	M37x1.0-6g 0.100R	111.00 g

All dimensions in inches (millimeters in parenthesis)

ACCESSORIES

DUMMY RECEPTACLES, DUST CAPS & PLUG CAPS



D38999	DTS	DUMMY RECEPTACLES	RECEPTACLE DUST CAPS		PLUG DUST CAP
			FOR FLANGED	FOR JAM NUT	
A	9	D38999/22A**	D38999/33**9R	D38999/33**9N	D38999/32**9##
B	11	D38999/22B**	D38999/33**11R	D38999/33**11N	D38999/32**11##
C	13	D38999/22C**	D38999/33**13R	D38999/33**13N	D38999/32**13##
D	15	D38999/22D**	D38999/33**15R	D38999/33**15N	D38999/32**15##
E	17	D38999/22E**	D38999/33**17R	D38999/33**17N	D38999/32**17##
F	19	D38999/22F**	D38999/33**19R	D38999/33**19N	D38999/32**19##
G	21	D38999/22G**	D38999/33**21R	D38999/33**21N	D38999/32**21##
H	23	D38999/22H**	D38999/33**23R	D38999/33**23N	D38999/32**23##
J	25	D38999/22J**	D38999/33**25R	D38999/33**25N	D38999/32**25##

** Select Code for Plating

W = Aluminium Olive Drab over Chromate

F = Aluminium Electroless Nickel

K = Stainless Steel

G = Aluminium Electroless Nickel Space Grade

= Select code for ring or loop

N = Ring to attach to backshell as shown

R = Loop for screw mounting

CABLE CLAMPS



D38999	DTS	STRAIGHT		RIGHT ANGLE		CABLE RANGE			
		LOW COST	SELF LOCKING	LOW COST	SELF LOCKING	MIN		MAX	
						INCHES	MM	INCHES	MM
A	9	M85049/38-9**	M85049/38S9**	M85049/39-9**	M85049/39S9**	0.098	2.49	0.234	5.94
B	11	M85049/38-11**	M85049/38S11**	M85049/39-11**	M85049/39S11**	0.153	3.89	0.234	5.94
C	13	M85049/38-13**	M85049/38S13**	M85049/39-13**	M85049/39S13**	0.190	4.83	0.328	8.33
D	15	M85049/38-15**	M85049/38S15**	M85049/39-15**	M85049/39S15**	0.260	6.60	0.457	11.61
E	17	M85049/38-17**	M85049/38S17**	M85049/39-17**	M85049/39S17**	0.283	7.19	0.614	15.60
F	19	M85049/38-19**	M85049/38S19**	M85049/39-19**	M85049/39S19**	0.325	8.25	0.634	16.10
G	21	M85049/38-21**	M85049/38S21**	M85049/39-21**	M85049/39S21**	0.343	8.71	0.698	17.73
H	23	M85049/38-23**	M85049/38S23**	M85049/39-23**	M85049/39S23**	0.381	9.68	0.823	20.90
J	25	M85049/38-25**	M85049/38S25**	M85049/39-25**	M85049/39S25**	0.418	10.62	0.853	21.67

** Select Plating

W = Aluminium Olive Drab over Chromate

F = Aluminium Electroless Nickel







K = Stainless Steel

G = Aluminium Electroless Nickel Space Grade

All dimensions in inches (millimeters in parenthesis)

ACCESSORIES

STANDARD MIL-SPEC

MIL-SPEC PREFIX	SEALED	EMI/RFI	S = STRAIGHT A = 90 DEGREES B = 45 DEGREES	ENDBELL TYPE	DESCRIPTION
M85049/62 	Y	N	S	Heat Shrink Boot Adapters	Designed for use with straight or right angle shrink boots. A knurled rear section with a boot groove provide an excellent surface for the boot to grab the metal endbell. Available with lock wire and drain holes. See Heat Shrink Boots on See Heat Shrink Boots on pages 168-169.
M85049/32 	N	N	S	Extender Backshell with cable clamp	Non-environmental, designed for use with jacketed cable, allows extra space to break out the wires and still provide strain relief clamping to the outside of the cable jacket.
M85049/17 	Y	Y	S	Environmental Shielded Endbell	This EMI/RFI shielding environmentally sealing endbell features a standard style cable clamp with gland seal at the end of and extender style backshell.
M85049/29 	N	Y	S	Non-Environmental Shielded Endbell	This EMI/RFI shielding non-environmentally sealing endbell features a standard style cable clamp.
M85049/85 M85049/86 M85049/87 	Y	Y	S B A	Banding Adapter	Banding adapters utilize a band of metal that fastens and grounds cable shields to the outside of endbells. This method of terminating shields has advantages in that they typically use tools to tighten trim the bands. These tools make the termination tight, repeatable, reworkable (if you make a mistake just cut the band off and start again) and facilitates service. Banding adapters help lower the total applied cost by having simpler designs that have fewer parts with uncomplicated assembly procedures.
M85049/27 	N	N	S	Compression Nut	Wire Seal Compression Nut

NOTE: If military-standard versions won't work for your applications, please contact us with your requirements.

ASSEMBLY INSTRUCTIONS

WIRE STRIPPING

Strip insulation from end of wire to be crimped. (See table for proper stripping dimensions.) Do not cut or damage wire strands.

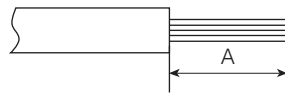

WIRE SIZE	A
22, 22M, 22D	.125 (3.18)
20	.188 (4.77)
16	.188 (4.77)
12	.188 (4.77)
10	.335 (8.51)
8 (power)	.470 (11.99)

CONTACT CRIMPING

correct crimp



incorrect crimp



STEP 1: Strip wires. See above for correct strip length for contact. Insert wire into rear of contact. Wire insulation must push against rear of contact. Wire must be visible through inspection hole.

STEP 2: M22520 series crimp tool and locator is recommended. → See page 68 here for choice of turret head and selection setting according to correct size, part number and wire gauge size.

STEP 3: Insert contact and wire into tool jaws. To crimp, squeeze handles together fully until ratchet releases and allows handles to expand; otherwise, contact cannot be extracted from tool jaws. Maintain slight insertion pressure on wire while crimping contact to wire.*

CONTACT INSERTION

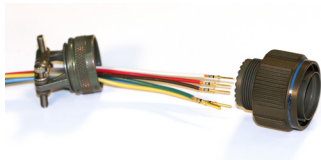

STEP 1: Remove hardware from plug or receptacle and slip over wire bundle in proper order for reassembly.



STEP 2: Using proper plastic or metal insertion tool for corresponding contact, position wire in tip of the tool so that the tool tip presses against the contact shoulder.

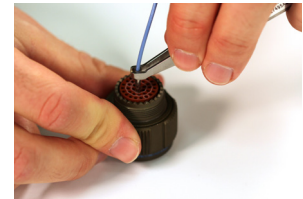

STEP 3: Press tool against contact shoulder and, with firm and even pressure, insert wired contact and tool tip into center contact cavity.

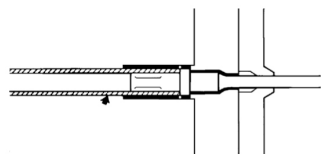

STEP 4: When contact bottoms, a slight "click" can be heard as tines of metal retaining clip snap into place behind contact shoulder.



STEP 5: Remove tool and pull back lightly on wire to make sure contact is properly seated. Repeat operation with remainder of contacts to be inserted, beginning with the center cavity and working outward in alternating rows.



STEP 6: After all contacts are inserted, fill any empty cavities with wire sealing plugs. Reassemble plug or receptacle hardware.

ASSEMBLY INSTRUCTIONS

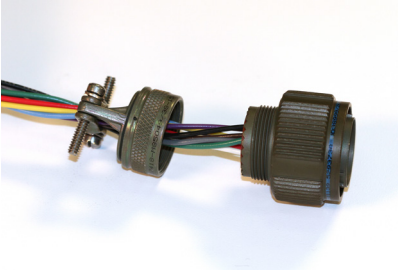

STEP 1: Remove hardware from plug or receptacle and slide hardware back along wire bundle.

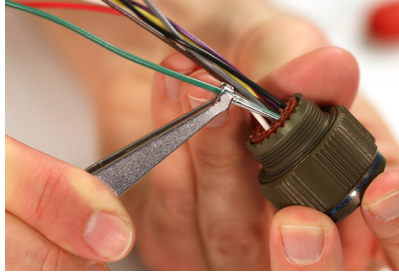

STEP 2: Using plastic or metal extraction tool with proper color code corresponding to contact size, place wire in tool.

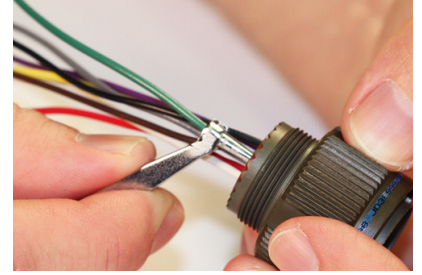

STEP 3: Insert tool into contact cavity until tool tip bottoms against the contact shoulder, expanding clip retaining tines.

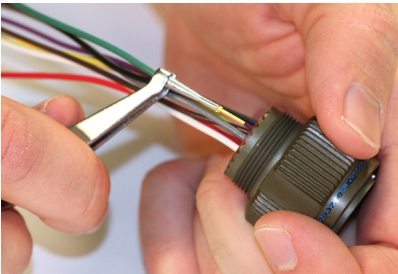

STEP 4: Hold wire firmly in tool and extract wired contact and tool. Repeat operation for all contacts to be extracted.



STEP 5: Fill any empty cavities with wire sealing plugs. Reassemble plug or receptacle hardware.

Note: DTS series shown.