



## MMIC SURFACE MOUNT

# Voltage Variable Attenuator **PVA-453-34+**

50Ω 10 to 45 GHz

### THE BIG DEAL

- Ultra-broad band, 10 to 45 GHz
- Wide attenuation range, up to 51 dB typ. at 30 GHz
- Excellent return loss for all attenuation states
- Low insertion loss, 2 dB typ.
- High IIP3 in all attenuation states



Generic photo used for illustration purposes only

CASE STYLE: JV2579

### +RoHS Compliant

The +Suffix identifies RoHS Compliance. See our website for methodologies and qualifications

### APPLICATIONS

- 5G MIMO and Back Haul Radio Systems
- Satellite Communications
- Test and Measurement Equipment
- Radar, EW, and ECM Defense Systems

### PRODUCT OVERVIEW

The PVA-453-34+ is an absorptive voltage variable attenuator MMIC die fabricated using GaAs pHEMT technology packaged in a small 3.5x2.5 mm SMT package. This VVA covers the frequency range of 10 to 45 GHz offering high dynamic range, low distortion, and low insertion loss. It features two independently controlled attenuators using analog control voltages from -4V to 0V. This product is ideal for applications where a DC voltage is utilized to control RF signal levels such as temperature compensation and AGC circuits.

### KEY FEATURES

Feature	Advantages
High IIP3, +26 to +43 dBm typ. over attenuation range	Low distortion enabling improved system performance.
Wide attenuation range, • 45 dB typ. at 20 GHz • 51 dB typ. at 30 GHz • 38 dB typ. at 40 GHz	Low insertion loss and high dynamic range simplify the use of analog signal control.



## MMIC SURFACE MOUNT

# Voltage Variable Attenuator **PVA-453-34+**

50Ω 10 to 45 GHz

### ELECTRICAL SPECIFICATIONS AT 25°C, 50Ω, UNLESS NOTED OTHERWISE

Frequency (GHz)	Condition <sup>1</sup>	Min Attenuation (dB) <sup>2</sup>		Max Attenuation (dB)		Attenuation Range (dB)		Return Loss (dB)		IIP3 (dBm) Worst Case, Typ
		Typ.	Max.	Min.	Typ.	Min.	Typ.	Min.	Typ.	
10-20	VCTL1 = -4 V to 0 V, VCTL2 = -4 V	2.1	3.5	18.8	23.8	15.3	21.7	7	17	30
20-30		2.2	3.7	22.9	27.6	19.2	25.4	7.5	14	
30-40		3.0	5.9	26.4	31.1	20.5	28.1	6.5	16	
40-45		4.1	6.3	28.8	34.0	22.5	29.9	10	19	
10-20	VCTL1 = 0 V, VCTL2 = -4 V to 0 V	23.8	28.3	32.1	41.6	3.8	17.7	7	14	30
20-30		27.6	31.8	41.8	51.9	10.0	24.3	7.5	13	
30-40		31.2	36.2	38.3	48.0	-	16.8	6.5	15	
40-45		34.0	36.5	34.7	38.0	-	4.0	10	18	
10-20	VCTL1 = -4 V to 0 V, VCTL2 = -4 V to 0 V VCTL1 = VCTL2	2.1	3.5	32.1	41.5	28.6	39.5	8	17	26
20-30		2.2	3.7	41.4	51.9	37.7	49.7	7.5	14	
30-40		3.0	5.9	37.9	48.0	32.0	45.0	6.5	16	
40-45		4.1	6.3	34.6	38.0	28.3	33.9	10	19	

1. VCTL1 and VCTL2: -4V (min. attenuation) to 0V (max. attenuation). Maximum current for VCTL1 or VCTL2: 5 mA (max at VCTL= -4V)

2. Min attenuation state is the insertion loss.

### MAXIMUM RATINGS<sup>3</sup>

Parameter	Ratings
Operating Case Temperature	-40°C to 85°C
Storage Temperature	-65°C to 150°C
Control Voltage (Vctl1/Vctl2)	-5 to +1V
Absolute Max. RF Input Level	+23 dBm
Thermal Resistance at max. attenuation	44.8°C/W

3. Permanent damage may occur if any of these limits are exceeded.



## MMIC SURFACE MOUNT

# Voltage Variable Attenuator **PVA-453-34+**

50Ω 10 to 45 GHz

### APPLICATION CIRCUIT & PAD DESCRIPTION

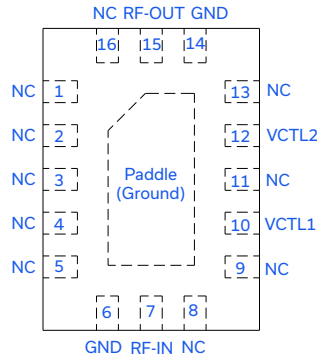
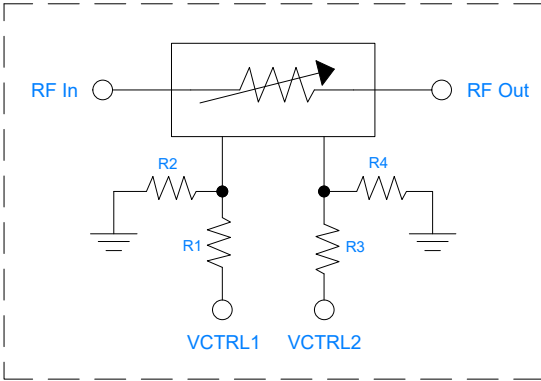

### PAD CONNECTIONS

NO CONNECTION	1, 2, 3, 4, 5, 8, 9, 11, 13, 16
RF IN	7
VCTL1	10
VCTL2	12
RF OUT	15
GROUND	6, 14

Components	Size	Value	Qty	Part Number
R1, R3	0201	6.2 kΩ	2	RK73414TTC6201F
R2, R4	0201	2.1 kΩ	2	RK73H1HT2010F

Note: The voltage divider network is required to increase the tuning voltage range of the VVA

### PRODUCT MARKING



Marking may contain other features or characters for internal lot control



### TYPICAL PERFORMANCE CURVES

Attenuation vs. Frequency at Various Control Voltages  
VCTRL 1 = -4 V to 0 V, VCTRL 2 = -4 V

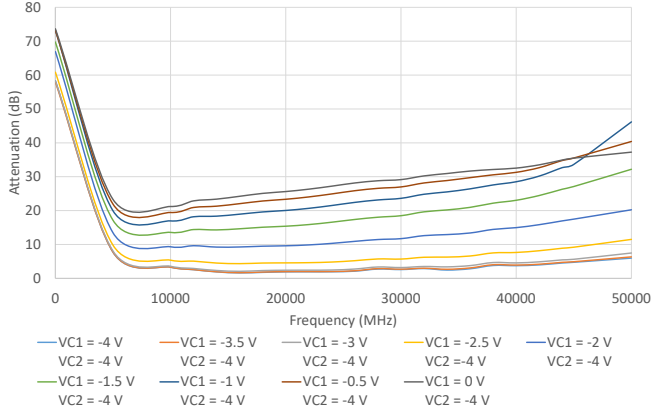

Input Return Loss vs. Frequency at Various Control Voltages  
VCTRL 1 = -4 V to 0 V, VCTRL 2 = -4 V

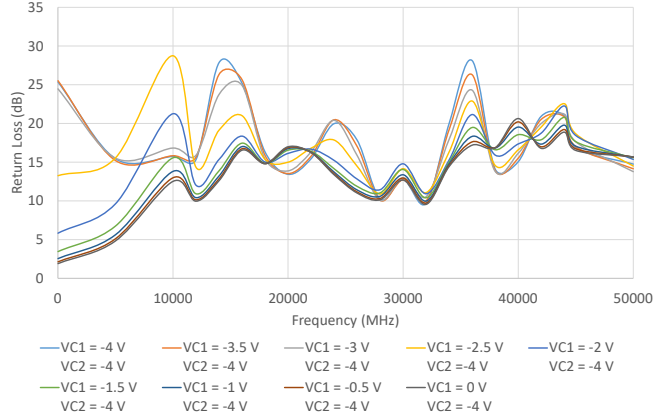

Output Return Loss vs. Frequency at Various Control Voltages  
VCTRL 1 = -4 V to 0 V, VCTRL 2 = -4 V

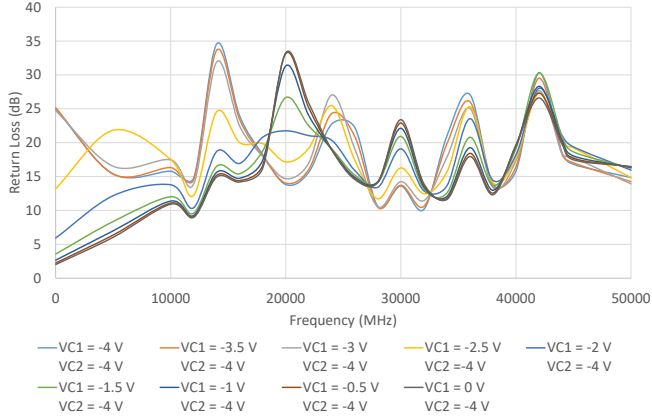

Attenuation vs. Frequency at Various Control Voltages  
VCTRL 1 = 0 V, VCTRL 2 = -4 V to 0 V

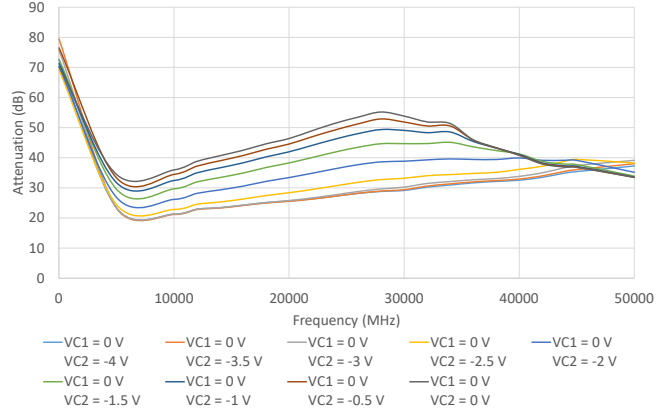

Input Return Loss vs. Frequency at Various Control Voltages  
VCTRL 1 = 0 V, VCTRL 2 = -4 V to 0 V

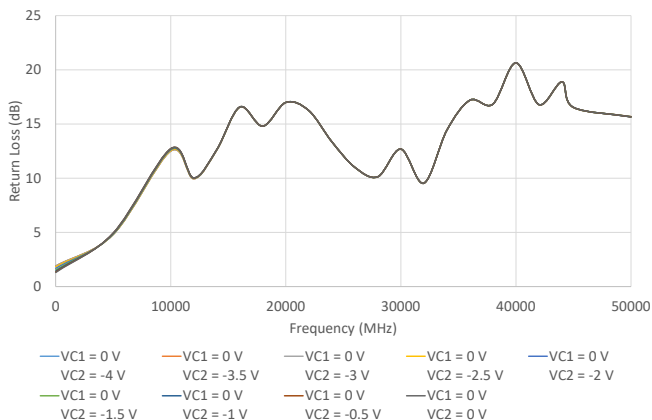

Output Return Loss vs. Frequency at Various Control Voltages  
VCTRL 1 = 0 V, VCTRL 2 = -4 V to 0 V

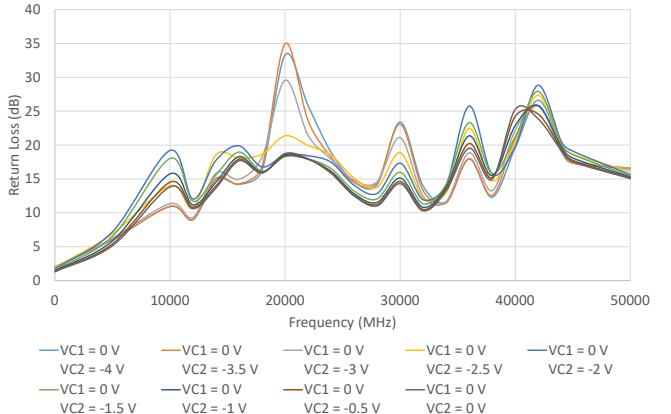



Attenuation vs. Frequency at Various Control Voltages  
VCTRL1 = VCTRL2 = -4 V to 0 V

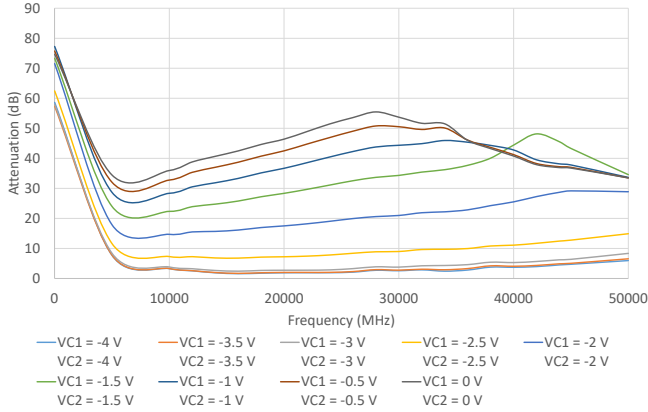

Input Return Loss vs. Frequency at Various Control Voltages  
VCTRL1 = VCTRL2 = -4 V to 0 V

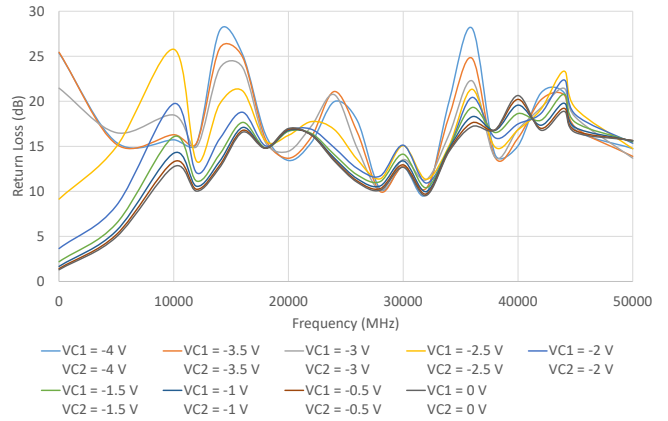

Output Return Loss vs. Frequency at Various Control Voltages  
VCTRL1 = VCTRL2 = -4 V to 0 V

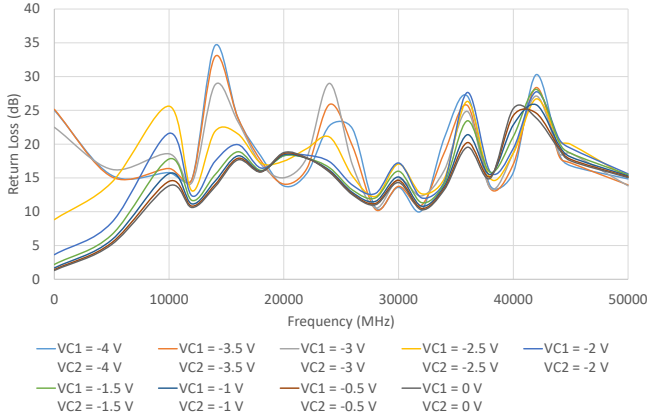

Attenuation vs. Control Voltage at Various Frequencies  
(VCTRL1 = VCTRL2)

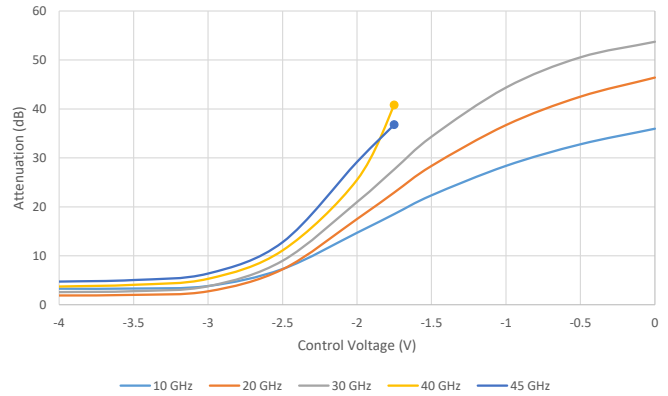

Noise Figure vs. Frequency

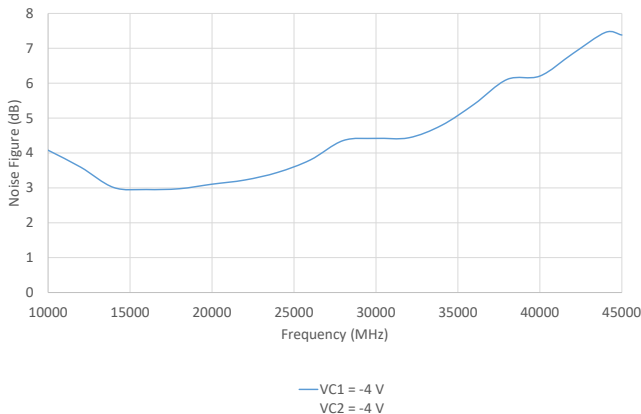



Attenuation vs. Input Power Over Control Voltages at 10 GHz (Fixed VCTRL2)

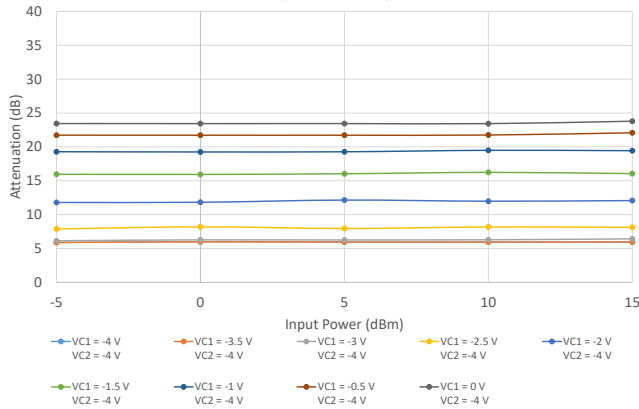

Attenuation vs. Input Power Over Control Voltages at 10 GHz (Fixed VCTRL1)

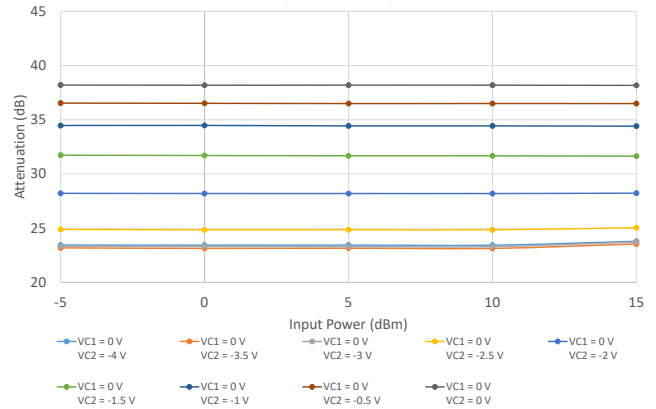

Attenuation vs. Input Power Over Control Voltages at 10 GHz (VCTRL1 = VCTRL2)

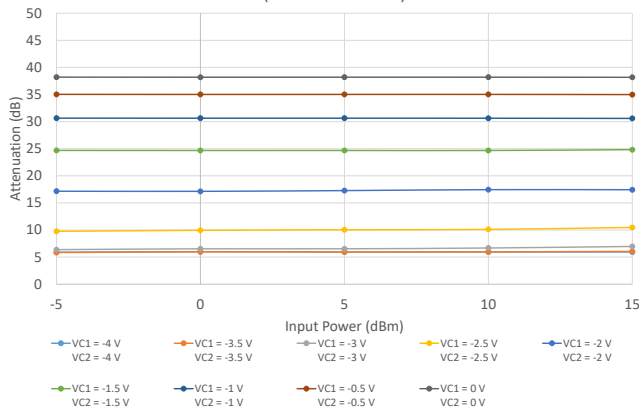

Attenuation vs. Input Power Over Control Voltages at 20 GHz (Fixed VCTRL2)

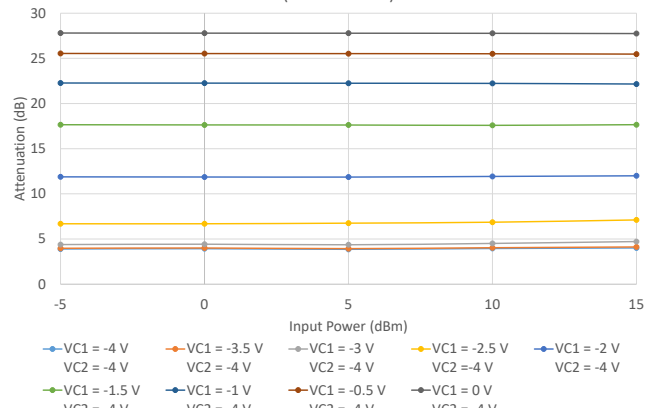

Attenuation vs. Input Power Over Control Voltages at 20 GHz (Fixed VCTRL1)

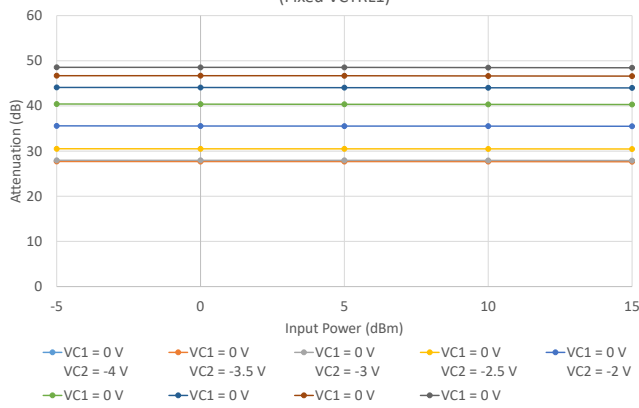

Attenuation vs. Input Power Over Control Voltages at 20 GHz (VCTRL1 = VCTRL2)

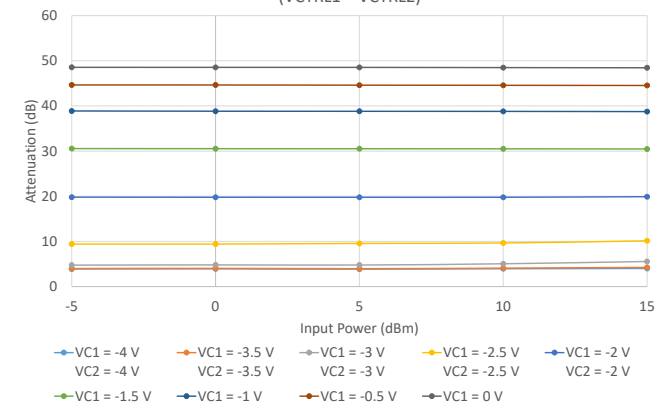

1. Package parasitics limit maximum attenuation range above 30 GHz and may cause attenuator to be non-monotonic with control voltages greater than -1.5V



# MMIC SURFACE MOUNT

# Voltage Variable Attenuator **PVA-453-34+**

50Ω 10 to 45 GHz

Attenuation vs. Input Power Over Control Voltages at 44 GHz  
(Fixed VCTRL2)

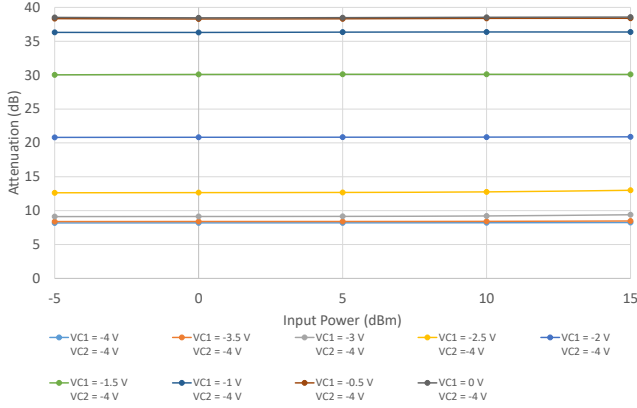

Attenuation vs. Input Power Over Control Voltages at 44 GHz  
(Fixed VCTRL1)

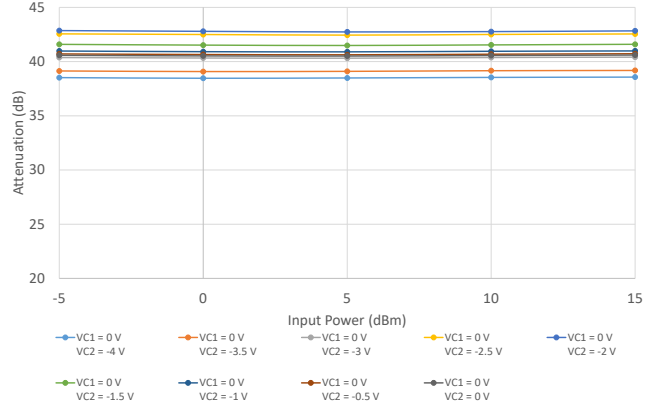

Attenuation vs. Input Power Over Control Voltages at 44 GHz  
(VCTRL1 = VCTRL2)

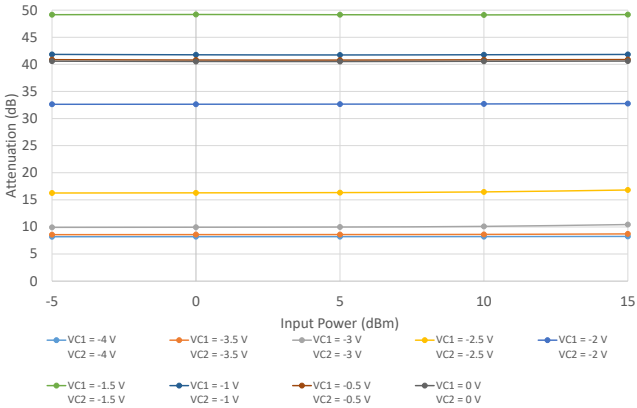

IIP3 vs. Input Power Over Control Voltages at 10 GHz  
(Fixed VCTRL2)

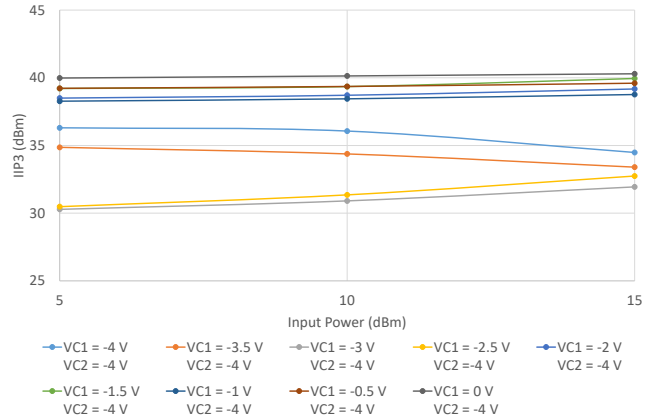

IIP3 vs. Input Power Over Control Voltages at 10 GHz  
(Fixed VCTRL1)

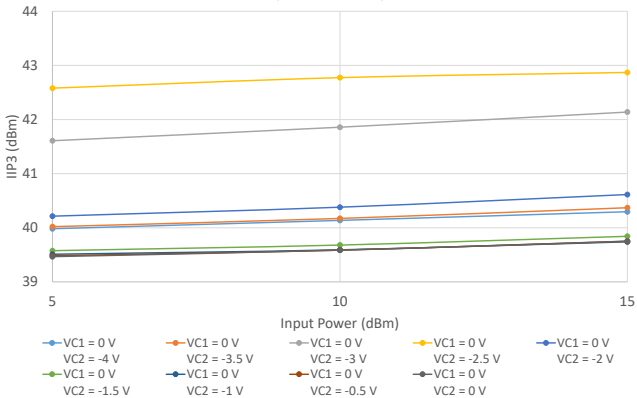

IIP3 vs. Input Power Over Control Voltages at 10 GHz  
(VCTRL1 = VCTRL2)

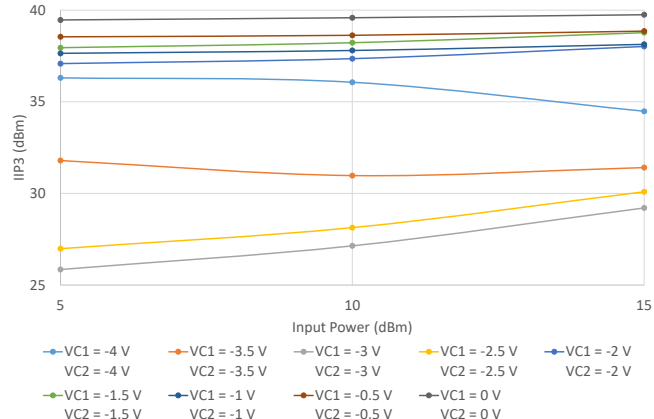



IIP3 vs. Input Power Over Control Voltages at 20 GHz (Fixed VCTRL2)

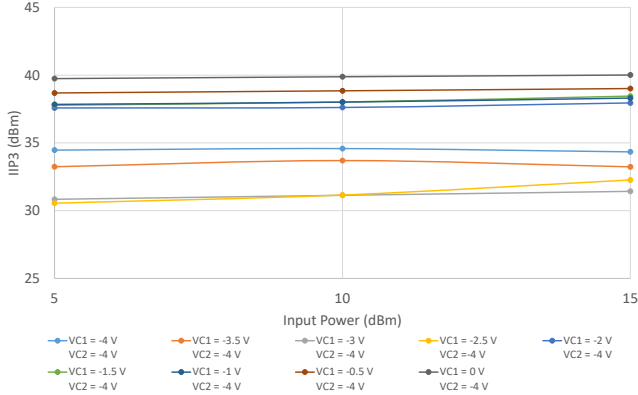

IIP3 vs. Input Power Over Control Voltages at 20 GHz (VCTRL1 = VCTRL2)

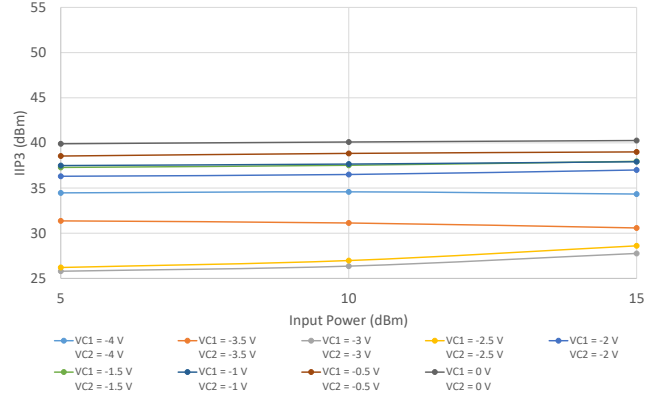

IIP3 vs. Input Power Over Control Voltages at 20 GHz (Fixed VCTRL1)

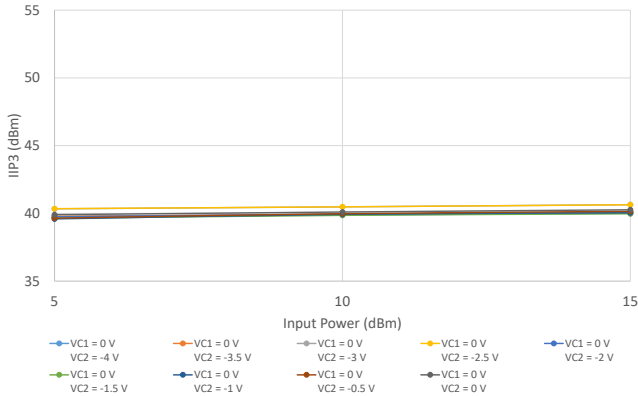

IIP3 vs. Input Power Over Control Voltages at 44 GHz (Fixed VCTRL2)

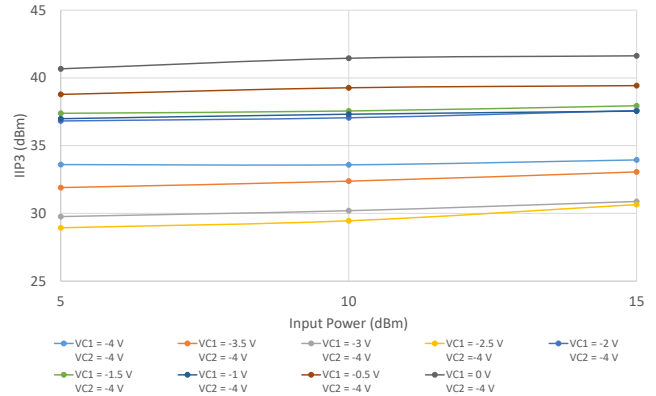

IIP3 vs. Input Power Over Control Voltages at 44 GHz (Fixed VCTRL1)

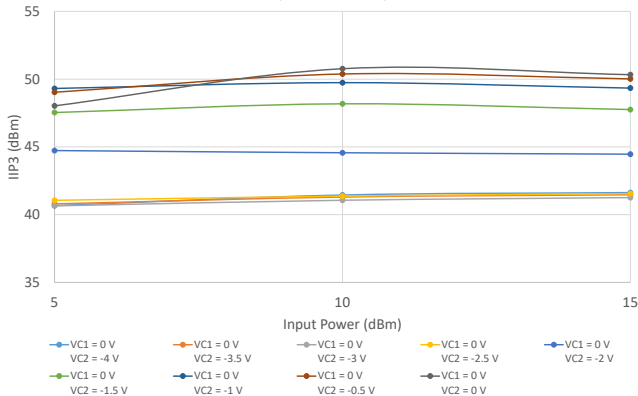

IIP3 vs. Input Power Over Control Voltages at 44 GHz (VCTRL1 = VCTRL2)

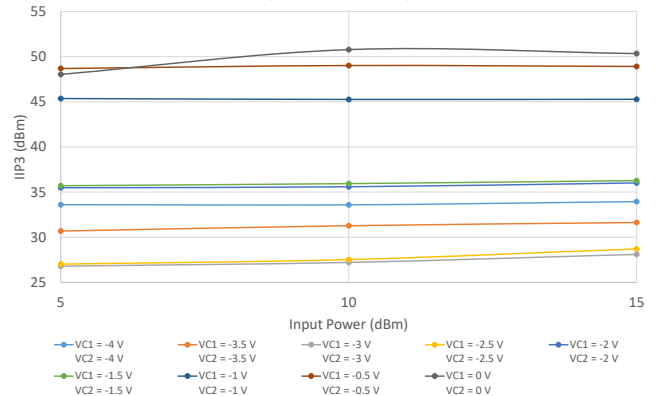





## MMIC SURFACE MOUNT

# Voltage Variable Attenuator **PVA-453-34+**

50Ω 10 to 45 GHz

**ADDITIONAL DETAILED TECHNICAL INFORMATION IS AVAILABLE ON OUR DASH BOARD. TO ACCESS [CLICK HERE](#)**

<b>Performance Data</b>	Data Table Swept Graphs S-Parameter (S2P Files) Data Set (.zip file)
<b>Case Style</b>	JV2579 Plastic package, exposed paddle, lead finish: Matte Tin
<b>Tape &amp; Reel</b>	F104
<b>Standard quantities available on reel</b>	7" reels with 20, 50, 100, 200, 500, 1K or 2K devices
<b>Suggested Layout for PCB Design</b>	PL-726
<b>Evaluation Board</b>	TB-PVA-453-34+ (without connectors), TB-PVA-453-34C+ (with connectors)
<b>Environmental Ratings</b>	ENV08T1

### ESD RATING

Human Body Model (HBM): Class 1A (250 V to < 500 V) in accordance with ANSI/ESD STM 5.1 - 2001

### MSL TEST FLOW CHART

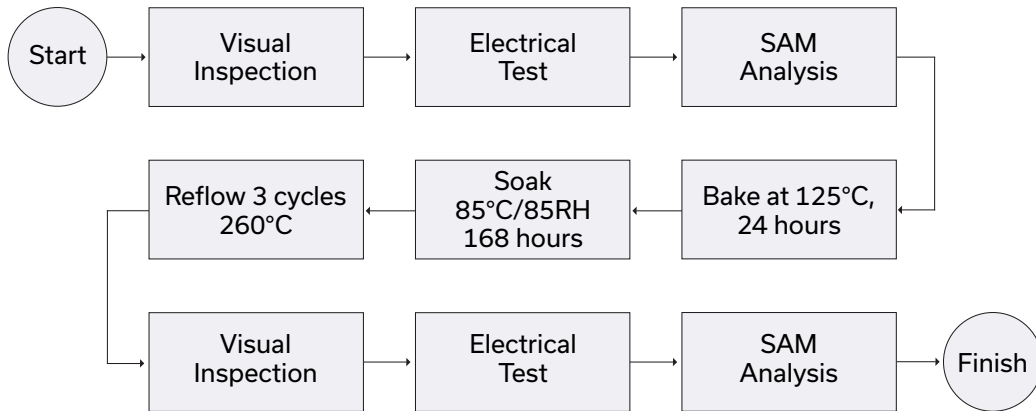

#### NOTES

- A. Performance and quality attributes and conditions not expressly stated in this specification document are intended to be excluded and do not form a part of this specification document.
- B. Electrical specifications and performance data contained in this specification document are based on Mini-Circuit's applicable established test performance criteria and measurement instructions.
- C. The parts covered by this specification document are subject to Mini-Circuits standard limited warranty and terms and conditions (collectively, "Standard Terms"); Purchasers of this part are entitled to the rights and benefits contained therein. For a full statement of the standard terms and the exclusive rights and remedies thereunder, please visit Mini-Circuits' website at [www.minicircuits.com/terms/viewterm.html](http://www.minicircuits.com/terms/viewterm.html)

