



Oct. 2019 Ver.3.0
TDK Corporation

Multilayer Diplexer

For LTE

DPX Series 2.5x2.0mm [EIA 1008] TYPE

P/N: **DPX252690DT-5225A1**

DPX252690DT-5225A1

■ SHAPES AND DIMENSIONS

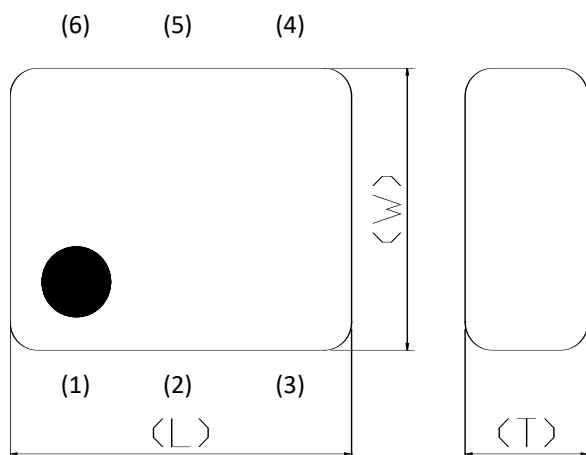
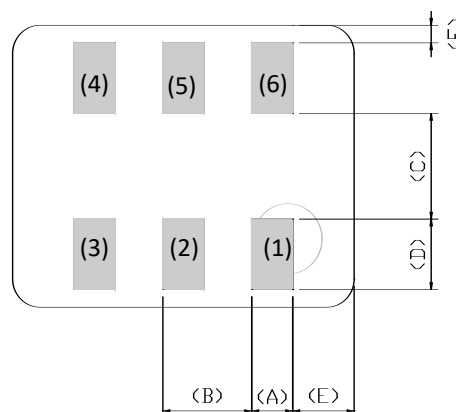
[Top View]**[Bottom View]**

Dimensions (mm)

L	W	T	A	B	C	D	E	F
2.50	2.00	0.80	0.40	0.65	0.75	0.525	0.40	0.10
+/-0.10	+/-0.10	+/-0.10	+/-0.10	+/-0.10	+/-0.10	+/-0.10	+/-0.10	+/-0.10

Terminal functions

(1)	High-Band Port
(2)	GND
(3)	Low-Band Port

(4)	GND
(5)	Common Port
(6)	GND

■ TEMPERATURE RANGE

Operating temperature	Storage temperature
-40 to +85 °C	-40 to +85 °C

■ TERMINATION FINISH

Material
Au plate

- All specifications are subject to change without notice.

DPX252690DT-5225A1

■ ELECTRICAL CHARACTERISTICS

(Measurement)

Low-Band

Parameter	Frequency (MHz)	TDK Spec		
		Min.	Typ.	Max.
Insertion Loss (dB)	699 to 960	-	0.44	0.60
	960 to 1427	-	0.54	0.75
	1427 to 1710	-	0.62	0.85
	1710 to 1990	-	0.79	1.00
	1990 to 2110	-	0.91	1.50
	2110 to 2170	-	1.62	2.50
Attenuation (dB)	2300 to 2350	5	12	-
	2350 to 2500	10	16	-
	2500 to 2690	10	14	-
Reutrn Loss (dB)	699 to 960	10	12	-
	960 to 1710	8	11	-
	1710 to 2170	10	15	-
Input Power Rating(W)	699 to 960	-	-	3
	960 to 1710	-	-	2
	1710 to 2170	-	-	1

Ta = +25+/-5°C

High-Band

Parameter	Frequency (MHz)	TDK Spec		
		Min.	Typ.	Max.
Insertion Loss (dB)	2300 to 2350	-	1.54	2.15
	2350 to 2500	-	0.87	1.50
	2500 to 2690	-	0.48	0.65
Attenuation (dB)	699 to 960	15	18	-
	960 to 1427	15	19	-
	1427 to 1710	12	14	-
	1710 to 1990	8	11	-
	1990 to 2110	8	11	-
	2110 to 2170	5	11	-
Reutrn Loss (dB)	2300 to 2690	10	16	-
Input Power Rating(W)	2300 to 2690	-	-	1

Ta = +25+/-5°C

DPX252690DT-5225A1

■ ELECTRICAL CHARACTERISTICS

(Measurement)

Common

Parameter	Frequency (MHz)	TDK Spec		
		Min.	Typ.	Max.
Return Loss (dB)	699 to 960	10	12	-
	960 to 1710	8	11	-
	1710 to 2170	10	13	-
	2300 to 2690	10	17	-
Isolation (dB)	699 to 960	15	17	-
	960 to 1427	15	18	-
	1427 to 1710	12	13	-
	1710 to 1990	8	11	-
	1990 to 2110	8	12	-
	2110 to 2170	5	15	-
	2300 to 2350	5	13	-
	2350 to 2500	10	17	-
	2500 to 2690	10	15	-

DPX252690DT-5225A1

Low band-Port

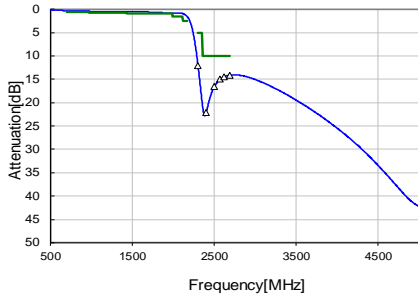

Attenuation	
2300 MHz	12.10 dB
2400 MHz	22.17 dB
2500 MHz	16.56 dB
2570 MHz	15.01 dB
2620 MHz	14.45 dB
2690 MHz	14.09 dB

High band-Port

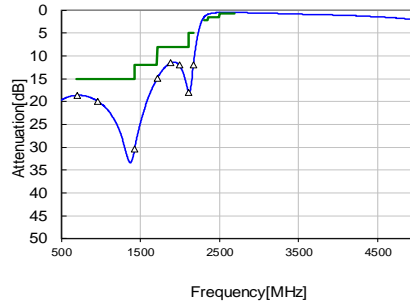

Attenuation	
699 MHz	18.62 dB
960 MHz	19.88 dB
1427 MHz	30.41 dB
1710 MHz	14.94 dB
1880 MHz	11.50 dB
1990 MHz	11.97 dB
2110 MHz	17.98 dB
2170 MHz	11.89 dB

Low band-Port

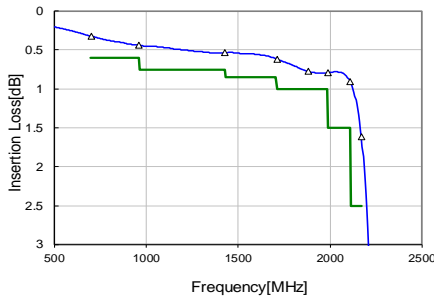

Insertion Loss	
699 MHz	0.32 dB
960 MHz	0.44 dB
1427 MHz	0.54 dB
1710 MHz	0.62 dB
1880 MHz	0.77 dB
1990 MHz	0.79 dB
2110 MHz	0.91 dB
2170 MHz	1.62 dB

High band-Port

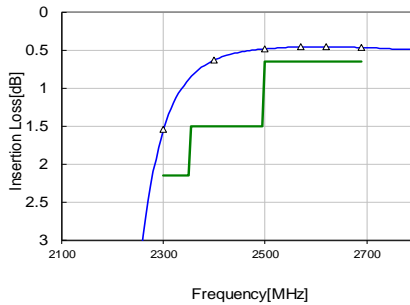

Insertion Loss	
2300 MHz	1.54 dB
2400 MHz	0.63 dB
2500 MHz	0.48 dB
2570 MHz	0.46 dB
2620 MHz	0.45 dB
2690 MHz	0.46 dB

Common Port Return Loss

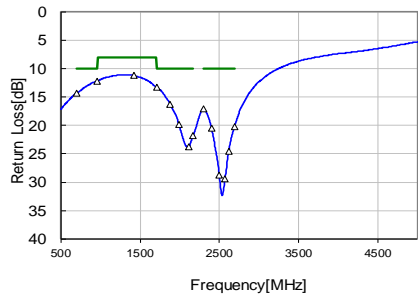

699 MHz	14.34 dB
960 MHz	12.25 dB
1427 MHz	11.22 dB
1710 MHz	13.31 dB
1880 MHz	16.25 dB
1990 MHz	19.80 dB
2110 MHz	23.79 dB
2170 MHz	21.78 dB
2300 MHz	17.11 dB
2400 MHz	20.49 dB
2500 MHz	28.77 dB
2570 MHz	29.36 dB
2620 MHz	24.58 dB
2690 MHz	20.18 dB

Isolation

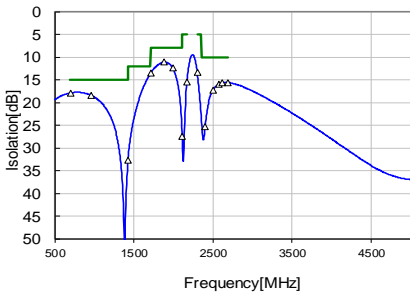

699 MHz	17.9 dB
960 MHz	18.4 dB
1427 MHz	32.7 dB
1710 MHz	13.6 dB
1880 MHz	11.1 dB
1990 MHz	12.4 dB
2110 MHz	27.5 dB
2170 MHz	15.5 dB
2300 MHz	13.4 dB
2400 MHz	25.2 dB
2500 MHz	17.2 dB
2570 MHz	15.9 dB
2620 MHz	15.6 dB
2690 MHz	15.6 dB

Low band-Port Return Loss

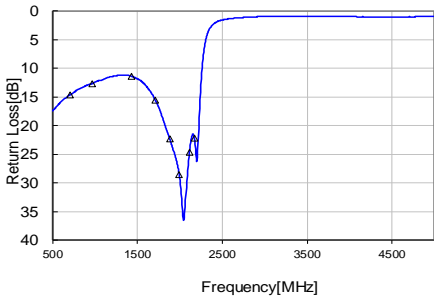

699 MHz	14.70 dB
960 MHz	12.69 dB
1427 MHz	11.39 dB
1710 MHz	15.61 dB
1880 MHz	22.36 dB
1990 MHz	28.52 dB
2110 MHz	24.63 dB
2170 MHz	22.15 dB

High band-Port Return Loss

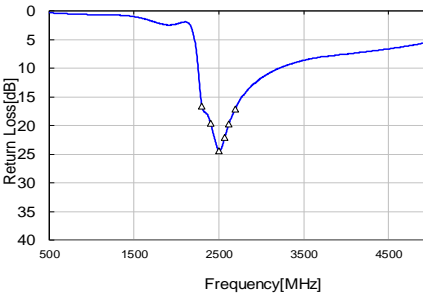

2300 MHz	16.67 dB
2400 MHz	19.59 dB
2500 MHz	24.36 dB
2570 MHz	22.05 dB
2620 MHz	19.70 dB
2690 MHz	17.19 dB

DPX252690DT-5225A1

RECOMMENDED LAND PATTERN

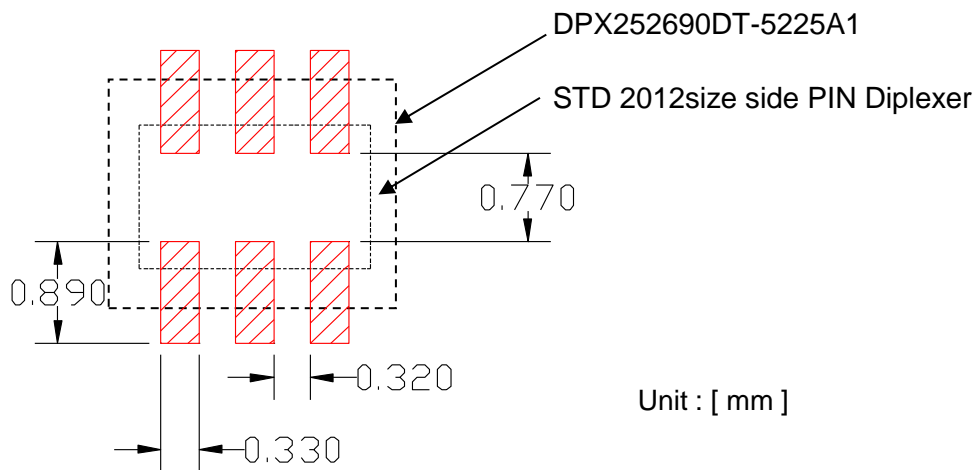

ENVIROMENT INFORMATION

RoHS Statement
RoHS Compliance

RECOMMENDED REFLOW PROFILE

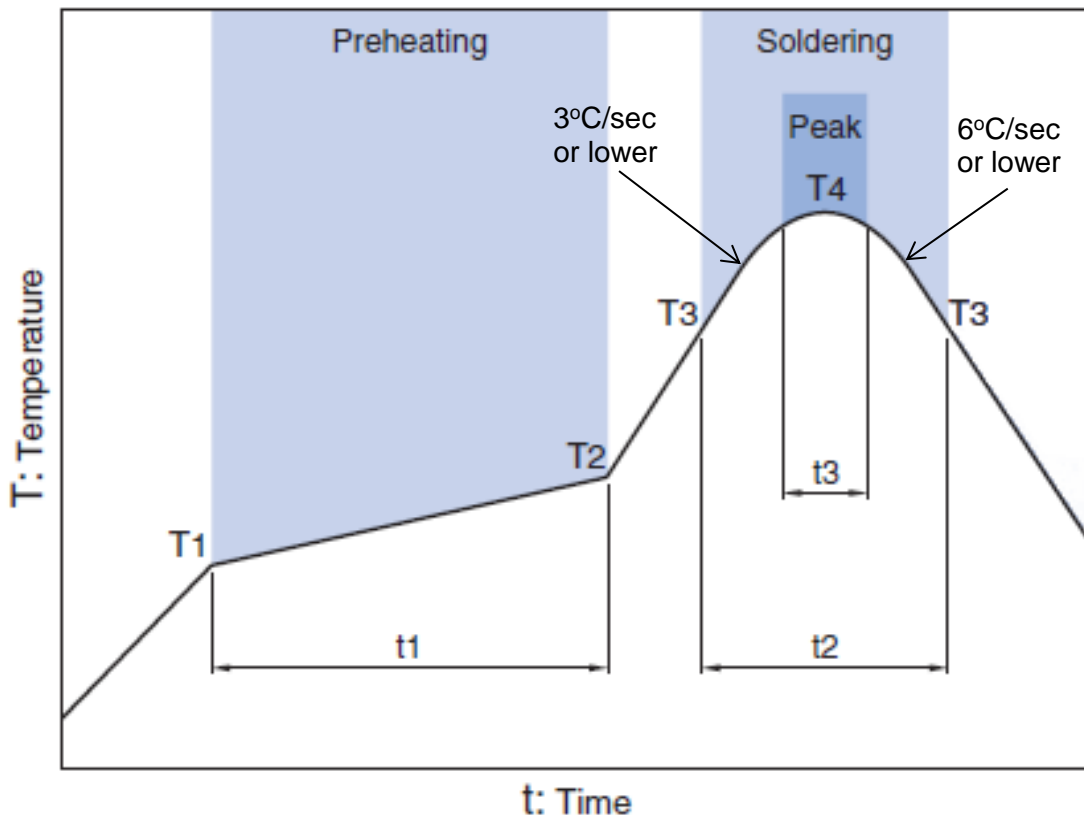

Preheating			Soldering			
			Critical zone (T3 to T4)		Peak	
Temp.	Temp.	Time	Temp.	Time	Temp.	Time
T1	T2	t1	T3	t2	T4	t3 *
150°C	200°C	60 to 120sec	217°C	60 to 120sec	240 to 260°C	30 sec Max

* t3 : Time within 5°C of actual peak temperature

The maximum number of reflow is 3.

Note: Lead free solder is recommended.
Recommended solder is Sn-3.0Ag-0.5Cu. (M705 by Senju Metal Industry)

DPX252690DT-5225A1**PACKAGING STYLE**

Reel Dimensions

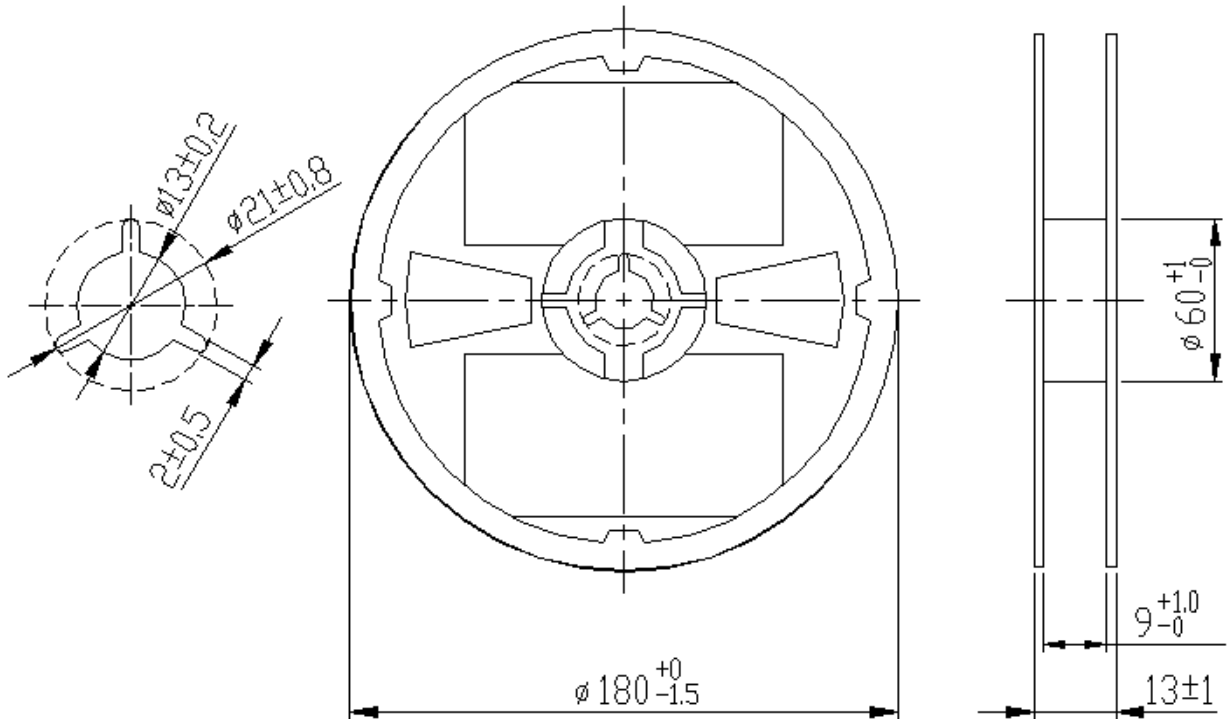

Dimensions in mm

Carrier Tape

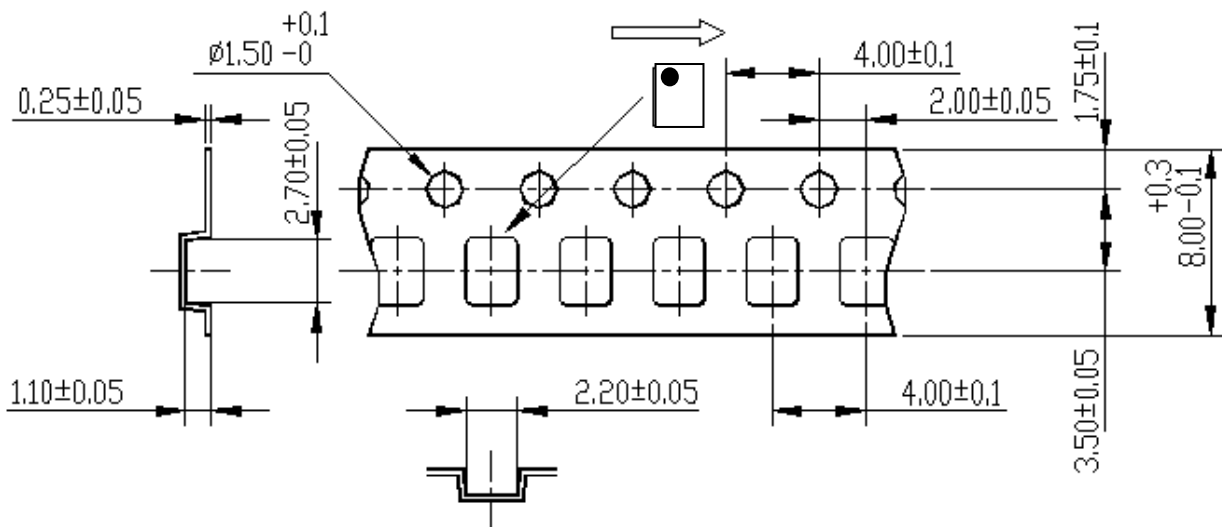

STANDARD PACKAGE QUANTITY (pieces/reel)
--

2,000

REMINDERS FOR USING THESE PRODUCTS

Before using these products, be sure to request the delivery specifications.

SAFETY REMINDERS

Please pay sufficient attention to the warnings for safe designing when using these products.

 **REMINDERS**

The products listed on this specification sheet are intended for use in general electronic equipment (AV equipment, telecommunications equipment, home appliances, amusement equipment, computer equipment, personal equipment, office equipment, measurement equipment, industrial robots) under a normal operation and use condition.

The products are not designed or warranted to meet the requirements of the applications listed below, whose performance and/or quality require a more stringent level of safety or reliability, or whose failure, malfunction or trouble could cause serious damage to society, person or property. Please understand that we are not responsible for any damage or liability caused by use of the products in any of the applications below or for any other use exceeding the range or conditions set forth in this specification sheet.

1. Aerospace/Aviation equipment
2. Transportation equipment (cars, electric trains, ships, etc.)
3. Medical equipment
4. Power-generation control equipment
5. Atomic energy-related equipment
6. Seabed equipment
7. Transportation control equipment
8. Public information-processing equipment
9. Military equipment
10. Electric heating apparatus, burning equipment
11. Disaster prevention/crime prevention equipment
12. Safety equipment
13. Other applications that are not considered general-purpose applications

When using this product in general-purpose applications, you are kindly requested to take into consideration securing protection circuit/equipment or providing backup circuits, etc., to ensure higher safety.