

## High Speed Infrared Emitting Diodes, 940 nm, Surface Emitter Technology



21531

### DESCRIPTION

As part of the [SurfLight™](#) portfolio, the VSMY1940X01 is an infrared, 940 nm emitting diode based on GaAlAs surface emitter chip technology with high radiant intensity, high optical power and high speed, molded in clear, untinted 0805 plastic package for surface mounting (SMD).

### FEATURES

- Package type: surface mount
- Package form: 0805
- Dimensions (L x W x H in mm): 2 x 1.25 x 0.85
- AEC-Q101 qualified
- Peak wavelength:  $\lambda_p = 940$  nm
- High reliability
- High radiant power
- High radiant intensity
- High speed
- Angle of half sensitivity:  $\phi = \pm 60^\circ$
- Suitable for high pulse current operation
- 0805 standard surface-mountable package
- Floor life: 168 h, MSL 3, according to J-STD-020
- Lead (Pb)-free reflow soldering
- Material categorization: for definitions of compliance please see [www.vishay.com/doc?99912](http://www.vishay.com/doc?99912)

 AUTOMOTIVE  
GRADE

**RoHS**  
COMPLIANT  
HALOGEN  
**FREE**  
**GREEN**  
(5-2008)

### APPLICATIONS

- IrDA compatible data transmission
- Miniature light barrier
- Photointerrupters
- Optical switch
- Emitter source for proximity sensors
- IR touch panels
- IR flash
- IR illumination
- 3D TV

| PRODUCT SUMMARY |               |              |                  |            |
|-----------------|---------------|--------------|------------------|------------|
| COMPONENT       | $I_e$ (mW/sr) | $\phi$ (deg) | $\lambda_p$ (nm) | $t_r$ (ns) |
| VSMY1940X01     | 10            | $\pm 60$     | 940              | 10         |

#### Note

- Test conditions see table "Basic Characteristics"

| ORDERING INFORMATION |               |                              |              |
|----------------------|---------------|------------------------------|--------------|
| ORDERING CODE        | PACKAGING     | REMARKS                      | PACKAGE FORM |
| VSMY1940X01          | Tape and reel | MOQ: 3000 pcs, 3000 pcs/reel | 0805         |

#### Note

- MOQ: minimum order quantity



| ABSOLUTE MAXIMUM RATINGS ( $T_{amb} = 25\text{ }^{\circ}\text{C}$ , unless otherwise specified) |   |            |             |                    |
|---|---|------------|-------------|--------------------|
| PARAMETER   | TEST CONDITION                              | SYMBOL     | VALUE       | UNIT               |
| Reverse voltage   |   | $V_R$      | 5           | V                  |
| Forward current   |   | $I_F$      | 100         | mA                 |
| Peak forward current  | $t_p/T = 0.5, t_p = 100\text{ }\mu\text{s}$ | $I_{FM}$   | 200         | mA                 |
| Surge forward current   | $t_p = 100\text{ }\mu\text{s}$              | $I_{FSM}$  | 1           | A                  |
| Power dissipation   |   | $P_V$      | 180         | mW                 |
| Junction temperature  |   | $T_j$      | 100         | $^{\circ}\text{C}$ |
| Operating temperature range   |   | $T_{amb}$  | -40 to +85  | $^{\circ}\text{C}$ |
| Storage temperature range   |   | $T_{stg}$  | -40 to +100 | $^{\circ}\text{C}$ |
| Soldering temperature   | According to Fig. 10, J-STD-020             | $T_{sd}$   | 260         | $^{\circ}\text{C}$ |
| Thermal resistance junction / ambient   | JESD 51                                     | $R_{thJA}$ | 250         | K/W                |

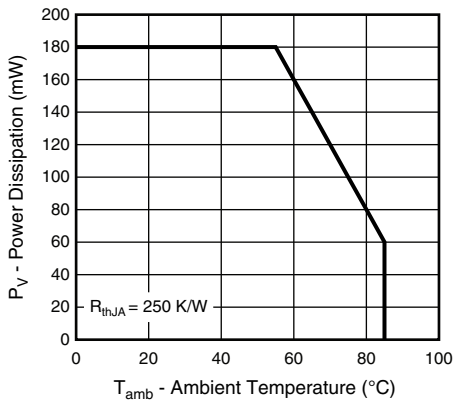

Fig. 1 - Power Dissipation Limit vs. Ambient Temperature

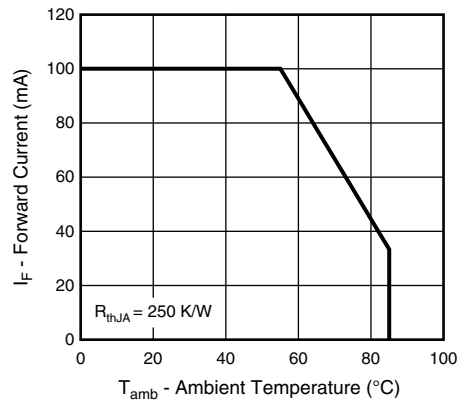

Fig. 2 - Forward Current Limit vs. Ambient Temperature

| BASIC CHARACTERISTICS ( $T_{amb} = 25\text{ }^{\circ}\text{C}$ , unless otherwise specified) |  |                  |                                    |          |      |               |
|--|--|------------------|------------------------------------|----------|------|---------------|
| PARAMETER  | TEST CONDITION   | SYMBOL           | MIN.                               | TYP.     | MAX. | UNIT          |
| Forward voltage  | $I_F = 100\text{ mA}, t_p = 20\text{ ms}$                  | $V_F$            | -                                  | 1.45     | 1.8  | V             |
|  | $I_F = 1\text{ A}, t_p = 100\text{ }\mu\text{s}$           | $V_F$            | -                                  | 2.2      | -    | V             |
| Temperature coefficient of $V_F$   | $I_F = 100\text{ mA}$                                      | $TK_{V_F}$       | -                                  | -2       | -    | mV/K          |
| Reverse current  |  | $I_R$            | Not designed for reverse operation |          |      | $\mu\text{A}$ |
| Junction capacitance   | $V_R = 0\text{ V}, f = 1\text{ MHz}, E = 0\text{ mW/cm}^2$ | $C_J$            | -                                  | 125      | -    | pF            |
| Radiant intensity  | $I_F = 100\text{ mA}, t_p = 20\text{ ms}$                  | $I_e$            | 5                                  | 10       | 15   | mW/sr         |
|  | $I_F = 1\text{ A}, t_p = 100\text{ }\mu\text{s}$           | $I_e$            | -                                  | 75       | -    | mW/sr         |
| Radiant power  | $I_F = 100\text{ mA}, t_p = 20\text{ ms}$                  | $\phi_e$         | -                                  | 50       | -    | mW            |
| Temperature coefficient of radiant power   | $I_F = 100\text{ mA}$                                      | $TK_{\phi_e}$    | -                                  | -0.2     | -    | %/K           |
| Angle of half intensity  |  | $\phi$           | -                                  | $\pm 60$ | -    | deg           |
| Peak wavelength  | $I_F = 100\text{ mA}$                                      | $\lambda_p$      | 920                                | 940      | 960  | nm            |
| Spectral bandwidth   | $I_F = 100\text{ mA}$                                      | $\Delta\lambda$  | -                                  | 40       | -    | nm            |
| Temperature coefficient of $\lambda_p$   | $I_F = 30\text{ mA}$                                       | $TK_{\lambda_p}$ | -                                  | 0.25     | -    | nm/K          |
| Rise time  | $I_F = 100\text{ mA}, 20\% \text{ to } 80\%$               | $t_r$            | -                                  | 10       | -    | ns            |
| Fall time  | $I_F = 100\text{ mA}, 20\% \text{ to } 80\%$               | $t_f$            | -                                  | 10       | -    | ns            |

**BASIC CHARACTERISTICS** ( $T_{amb} = 25\text{ }^{\circ}\text{C}$ , unless otherwise specified)

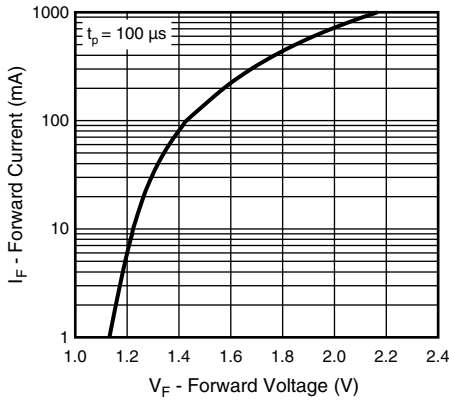

Fig. 3 - Forward Current vs. Forward Voltage

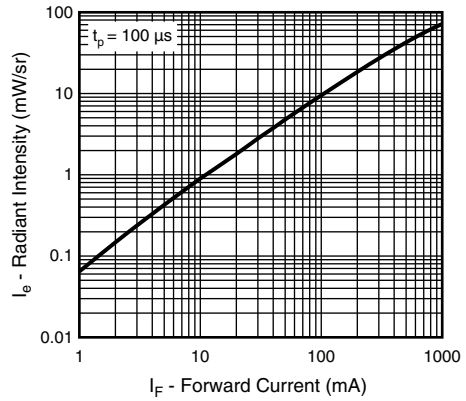

Fig. 6 - Radiant Intensity vs. Forward Current

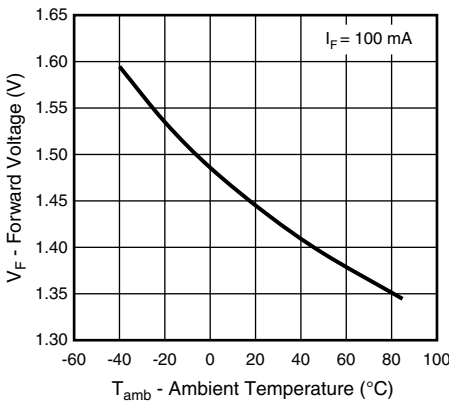

Fig. 4 - Forward Voltage vs. Ambient Temperature

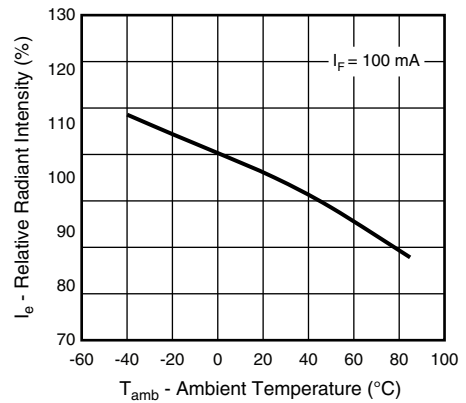

Fig. 7 - Relative Radiant Intensity vs. Ambient Temperature

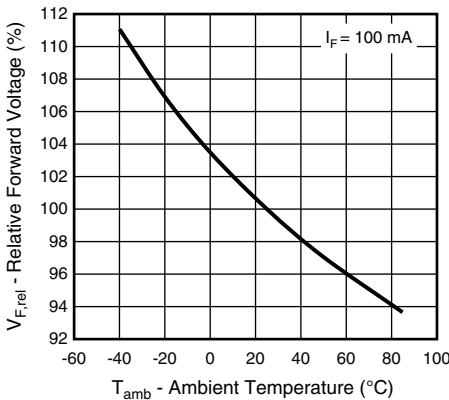

Fig. 5 - Relative Forward Voltage vs. Ambient Temperature

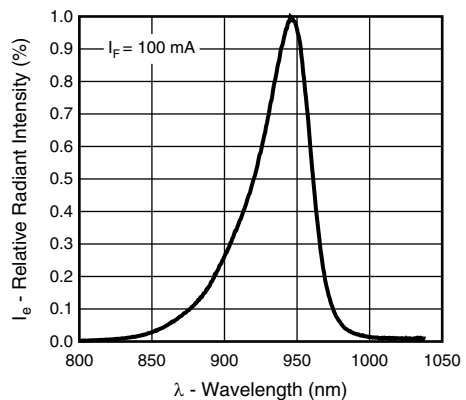

Fig. 8 - Relative Radiant Intensity vs. Wavelength

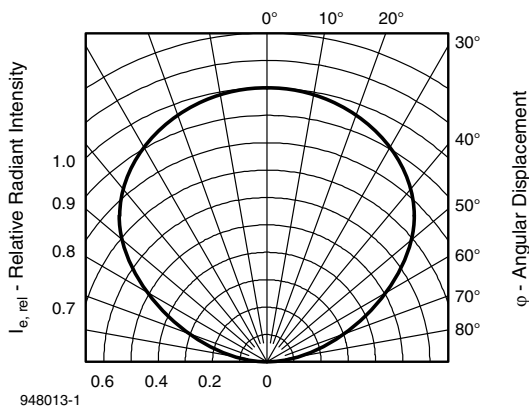

Fig. 9 - Relative Radiant Intensity vs. Angular Displacement

**DRYPACK**

Devices are packed in moisture barrier bags (MBB) to prevent the products from moisture absorption during transportation and storage. Each bag contains a desiccant.

**FLOOR LIFE**

Time between soldering and removing from MBB must not exceed the time indicated in J-STD-020:

Moisture sensitivity: level 3

Floor life: 168 h

Conditions:  $T_{amb} < 30\text{ }^{\circ}\text{C}$ ,  $\text{RH} < 60\text{ } \%$

**DRYING**

In case of moisture absorption devices should be baked before soldering. Conditions see J-STD-020 or label. Devices taped on reel dry using recommended conditions 192 h at  $40\text{ }^{\circ}\text{C}$  ( $+ 5\text{ }^{\circ}\text{C}$ ),  $\text{RH} < 5\text{ } \%$ .

**REFLOW SOLDER PROFILE**

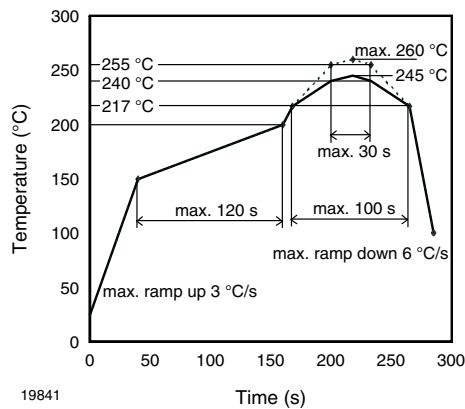
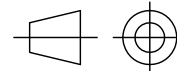
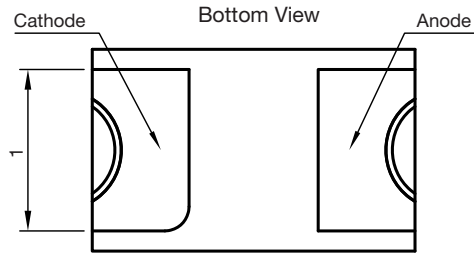

Fig. 10 - Lead (Pb)-free Reflow Solder Profile According to J-STD-020



PACKAGE DIMENSIONS in millimeters



technical drawings according to DIN specifications

Not indicated tolerances  $\pm 0.1$

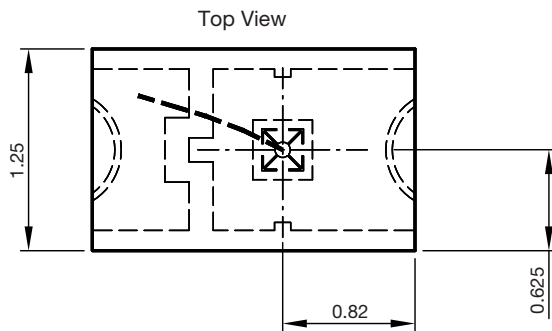
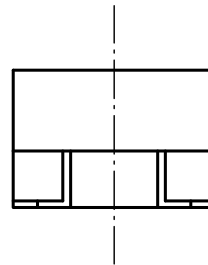
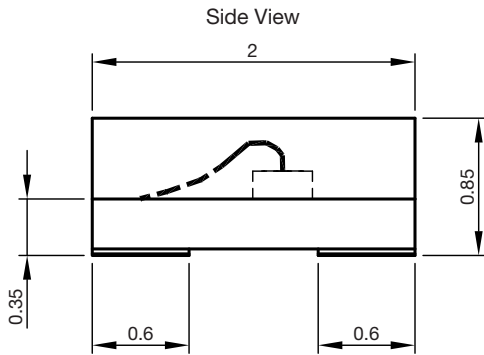

Recommended solder pad Footprint

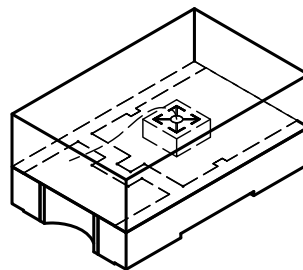
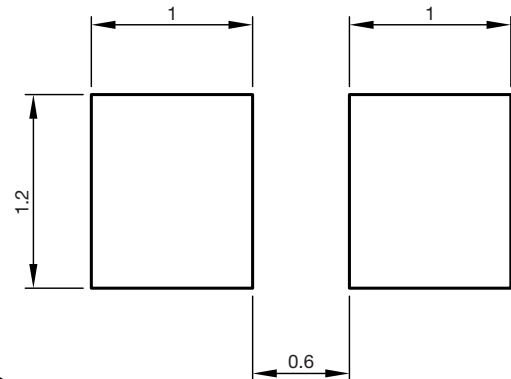

Drawing-No.: 6.541-5083.01-4  
Issue: 1; 29.03.10  
22111



**BLISTER TAPE DIMENSIONS** in millimeters

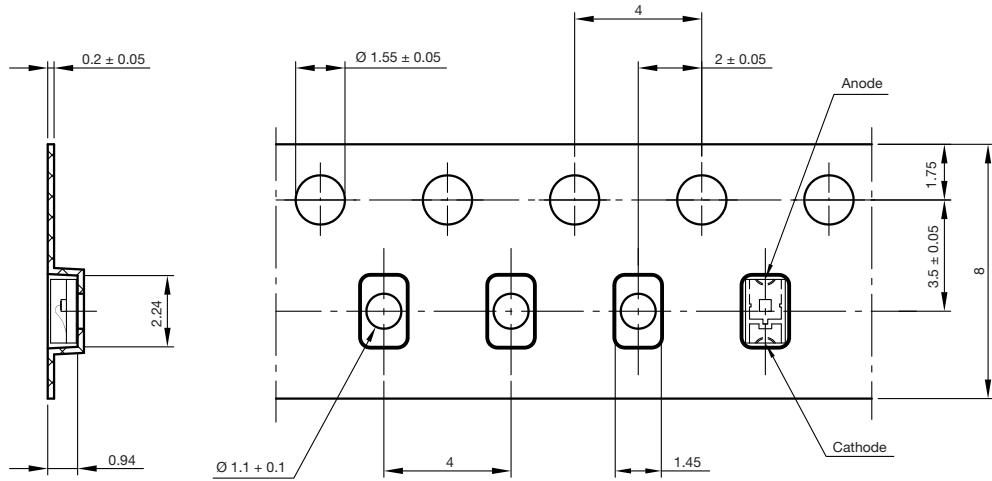

Not indicated tolerances ±0.1

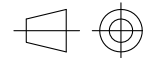

technical drawings according to DIN specifications

Drawing-No.: 9.700-5352.01-4  
Issue: 1; 13.04.10  
22112

**REEL DIMENSIONS** in millimeters

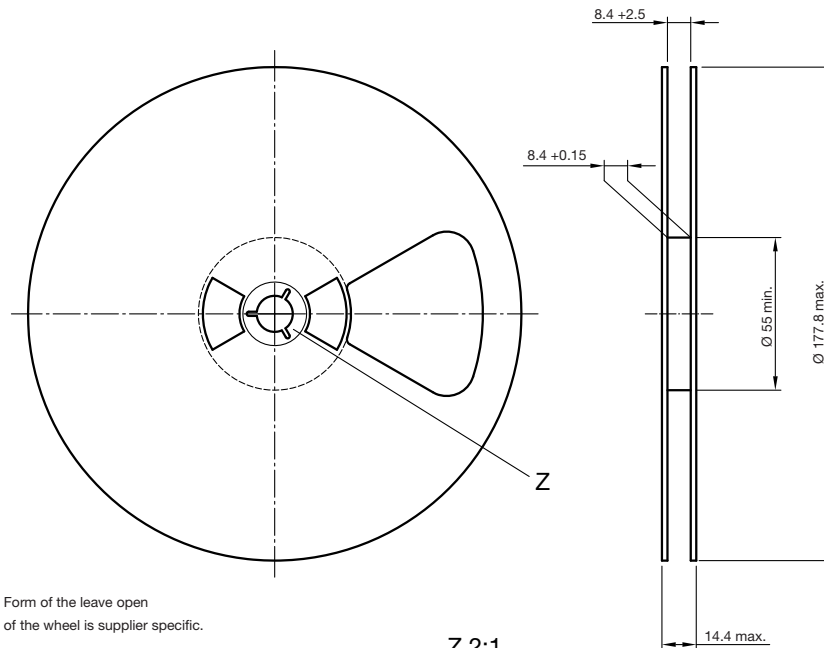

Form of the leave open of the wheel is supplier specific.

Z 2:1

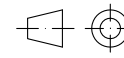
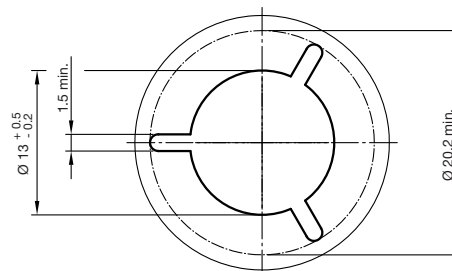

technical drawings according to DIN specifications

Drawing-No.: 9.800-5096.01-4  
Issue: 2; 26.04.10  
20875



## Disclaimer

ALL PRODUCT, PRODUCT SPECIFICATIONS AND DATA ARE SUBJECT TO CHANGE WITHOUT NOTICE TO IMPROVE RELIABILITY, FUNCTION OR DESIGN OR OTHERWISE.

Vishay Intertechnology, Inc., its affiliates, agents, and employees, and all persons acting on its or their behalf (collectively, "Vishay"), disclaim any and all liability for any errors, inaccuracies or incompleteness contained in any datasheet or in any other disclosure relating to any product.

Vishay makes no warranty, representation or guarantee regarding the suitability of the products for any particular purpose or the continuing production of any product. To the maximum extent permitted by applicable law, Vishay disclaims (i) any and all liability arising out of the application or use of any product, (ii) any and all liability, including without limitation special, consequential or incidental damages, and (iii) any and all implied warranties, including warranties of fitness for particular purpose, non-infringement and merchantability.

Statements regarding the suitability of products for certain types of applications are based on Vishay's knowledge of typical requirements that are often placed on Vishay products in generic applications. Such statements are not binding statements about the suitability of products for a particular application. It is the customer's responsibility to validate that a particular product with the properties described in the product specification is suitable for use in a particular application. Parameters provided in datasheets and / or specifications may vary in different applications and performance may vary over time. All operating parameters, including typical parameters, must be validated for each customer application by the customer's technical experts. Product specifications do not expand or otherwise modify Vishay's terms and conditions of purchase, including but not limited to the warranty expressed therein.

Hyperlinks included in this datasheet may direct users to third-party websites. These links are provided as a convenience and for informational purposes only. Inclusion of these hyperlinks does not constitute an endorsement or an approval by Vishay of any of the products, services or opinions of the corporation, organization or individual associated with the third-party website. Vishay disclaims any and all liability and bears no responsibility for the accuracy, legality or content of the third-party website or for that of subsequent links.

Vishay products are not designed for use in life-saving or life-sustaining applications or any application in which the failure of the Vishay product could result in personal injury or death unless specifically qualified in writing by Vishay. Customers using or selling Vishay products not expressly indicated for use in such applications do so at their own risk. Please contact authorized Vishay personnel to obtain written terms and conditions regarding products designed for such applications.

No license, express or implied, by estoppel or otherwise, to any intellectual property rights is granted by this document or by any conduct of Vishay. Product names and markings noted herein may be trademarks of their respective owners.