

# Variable speed drives Altivar 32

For 3-phase motors from 0.18 to 15 kW

Catalogue

April 2010





All technical information about products listed in this catalogue are now available on:

[www.schneider-electric.com](http://www.schneider-electric.com)

Browse the “product data sheet” to check out:

- characteristics,
- dimensions,
- curves, ...
- and also the links to the user guides and the CAD files.

**1** From the home page, type the model number\* into the “Search” box.

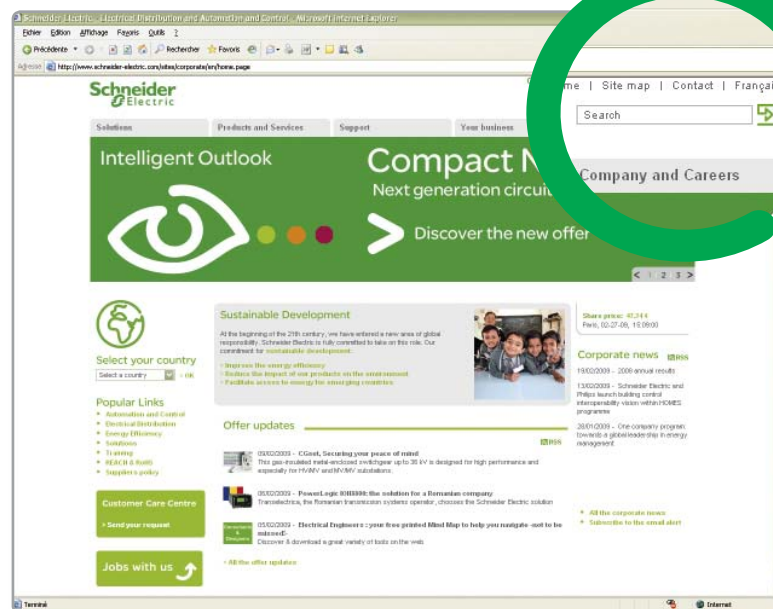

\* type the model number without any blank, replace “.” by “\*”

**2** Under “All” tab, click the model number that interests you.

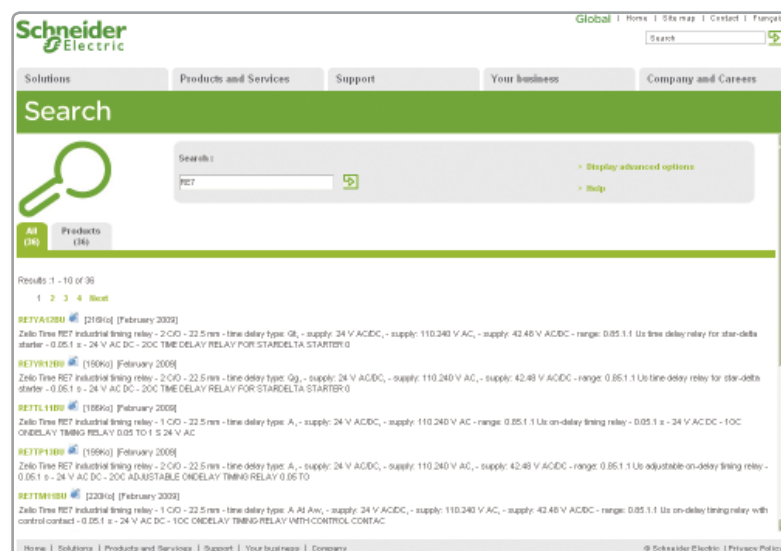

### 3 The product data sheet displays.

Example : Zelio Time data sheet

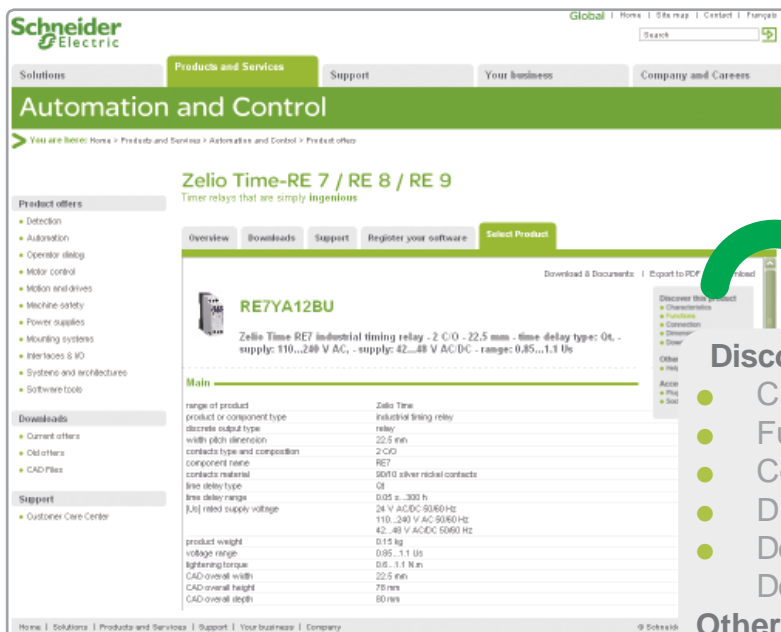

- Discover this product**
- Characteristics
  - Functions
  - Connection
  - Dimensions
  - Download & Documents
- Other products**
- Help me to choose
- Accessories**
- Plug
  - Sockets

Example : Zelio Time data sheet

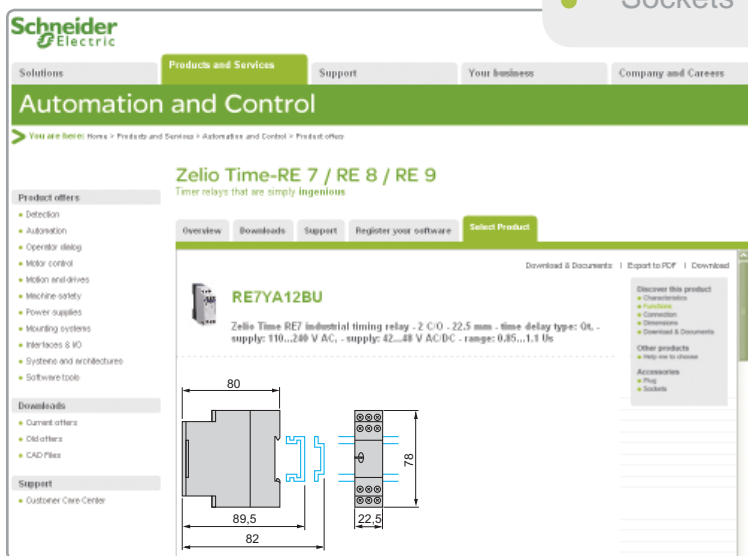

Example : Zelio Time data sheet



☑ You can get this information in one single pdf file.



# Variable speed drives Altivar 32

---

- Offer for complex machines ..... page 4
- Presentation ..... page 6
- Variable speed drives Altivar 32
  - References ..... page 12
- Options
  - Accessories ..... page 13
  - Dialogue tools, configuration tools ..... page 14
  - Braking resistors ..... page 17
  - Line chokes ..... page 18
  - Motor chokes ..... page 19
  - Integrated EMC filters and additional EMC input filters ..... page 20
  - Communication buses and networks ..... page 22
- SoMove setup software ..... page 28
- Motor starters ..... page 32

# Offer for complex machines **Altivar 32 variable speed drives and Lexium 32 motion control**

Application areas	Commons
	Specific
Technology type	

Printing, material handling, conveying, transfer machines, packaging, textiles, etc.
Hoisting, wood-working or metal processing machines, etc.
<b>Altivar 32 variable speed drives without sensor (velocity control)</b>



<b>Power range for 50...60 Hz (kW) line supply</b>	
	Single-phase 100...120 V (kW)
	Single-phase 200...240 V (kW)
	Three-phase 380...480 V (kW)
	Three-phase 380...500 V (kW)

0.18...15
–
0.18...2.2
–
0.37...15

<b>Drive</b>	Motor speed	
	Type of control	Asynchronous motor
		Synchronous motor
	Motor sensor	Integrated
		Available as an option
Transient overtorque		
Peak current		

0.1...599 Hz
Voltage/frequency ratios: U/f and 5-point U/f
Sensorless flux vector control ratio
Kn <sup>2</sup> quadratic ratio (pump/fan)
Energy saving ratio
Ratio for synchronous motor without sensor
–
–
170...200% of the nominal motor torque
–

<b>Number of functions</b>	
<b>Safety functions</b>	Integrated
	Available as an option

150
1: STO (Safe Torque Off)
3: SLS (Safe Limited Speed), SDI (Safe Direction Information), SS1 (Safe Stop 1)

<b>Number of I/O</b>	Inputs	Analog
		Logic
	Outputs	Analog
		Logic
Relay outputs		

3
6
1: configurable as voltage (0-10 V) or current (0-20 mA)
1
2

<b>Communication</b>	Integrated
	Available as an option
	Bluetooth link®

Modbus, CANopen
DeviceNet, PROFIBUS DP V1, EtherNet/IP, Modbus TCP, EtherCat (▲)
Integrated

<b>Options</b>	
----------------	--

SoMove setup software
Multi-Loader configuration tool
Graphic display terminal
Filters, braking resistors, line chokes

<b>Standards and certifications</b>	
-------------------------------------	--

IEC 61800-5-1, IEC 61800-3 (environments 1 and 2, category C2), UL 508C, EN 954-1 category 3, ISO/EN 13849-1/- 2 category 3 (PL d), IEC 61508 (parts 1 & 2) SIL 2 level, draft standard EN 50495E
CE, UL, CSA, C-Tick, NOM, GOST

<b>References</b>	
-------------------	--

<b>ATV 32</b>
---------------

<b>Pages</b>	
--------------	--

12
----

▲ Available 3rd quarter 2010



More technical information on [www.schneider-electric.com](http://www.schneider-electric.com) . . . please consult the end pages of this catalogue





Example with six 45 mm wide drives mounted side-by-side



Synergy between Altivar 32 drive and Lexium 32 servo drive (1)

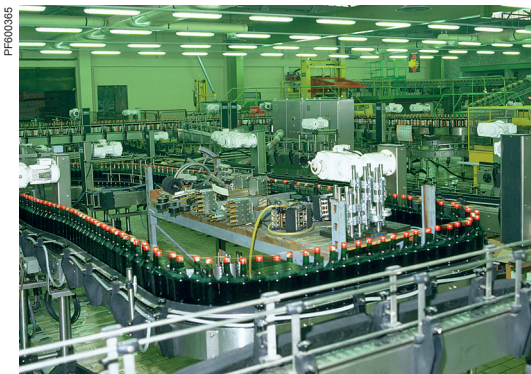

Conveying application

### Presentation

The Altivar 32 drive is a frequency inverter for 200...500 V three-phase asynchronous and synchronous motors rated from 0.18 to 15 kW.

By taking account of constraints on product setup and use right from the design stage, we are able to simplify its integration into industrial machines. The Altivar 32 drive features more than 150 functions and is robust, compact and easy to install.

Up to 4 kW, the Altivar 32 drive is 45 or 60 mm wide, saving a considerable amount of space in an installation. It has also been designed to be mounted side by side or on its side in densely-packed or shallow enclosures.

The Altivar 32 drive also offers functions which satisfy the demands of specific applications:

- The safety function guarantees a high level of safety (SIL 2 according to standard IEC 61508) comparable with performance level “d” (PL d) according to ISO/EN 13849-1/-2.
- The ATV Logic function offers simple control system functions (Boolean, arithmetical operations, comparators, etc.).

With various communication cards available as options, the Altivar 32 drive integrates perfectly into the main control system architectures.

The Altivar 32 drive includes various motor control profiles for three-phase asynchronous motors. It also features a special control profile for permanent magnet synchronous motors. Being compact and highly energy efficient, these motors are particularly suitable for conveying applications.

### Simplified setup and use

Examples of solutions to simplify setup and use:

- Compatibility with all dialogue and configuration tools for Altivar 32 variable speed drives and Lexium 32 servo drives (SoMove setup software, SoMove Mobile software for mobile phones, remote display terminals and the Simple Loader and Multi-Loader configuration tools)
- Built-in Bluetooth® link
- Easy-fit communication cards in cassette format
- Optimised offer for connection to the CANopen machine bus
- Different mounting options depending on the machine (vertical, horizontal, with the option to offset the control module when the drive is mounted on its side (to save space depthwise), side-by-side)
- Quick connect for a TeSys GV2 L magnetic circuit-breaker (which can be equipped with numerous TeSys accessories)
- Labelled terminals
- Synergy with Lexium 32 servo drives for controlling applications involving asynchronous and synchronous motors (common tools and options, same shape and dimensions, etc.)

The Altivar 32 drive is also compatible with SoMachine, the software solution for OEMs. This solution can be used to develop, configure and set up an entire machine in a single software environment.

### Applications

The Altivar 32 drive incorporates functions which are suitable for the most common applications, including:

- Material handling (small conveyors, hoists, etc.)
- Packing and packaging machines (small bagging machines, labelling machines, etc.)
- Special machines (mixers, kneaders, transfer machines, textile machines, etc.)
- Pumps, compressors, fans
- Hoisting
- Wood-working machinery (saws, gummings, planers, etc.)
- Metal processing (bending presses, welding machines, cutting machines, etc.)

(1) Please refer to the “Lexium 32 motion control” catalogue.



### Main functions (1)



Example of an application requiring the use of safety functions

The Altivar 32 drive has six logic inputs, three analog inputs, one logic/analog output and two relay outputs.

#### Application functions

The Altivar 32 drive includes 150 functions for handling, in particular:

- Configurations: standard or customisable
- Settings: factory or OEM
- Application-specific functions (conveying, cutting, hoisting, etc.)
- The adjustable switching frequency for optimizing servo control (adjusted motor current, reduced motor noise and temperature rise, etc.)
- The various Human-Machine Interfaces (HMIs) and dialogue or configuration tools
- Menu parameter setting, using the “My Menu” function to obtain an application-specific Human-Machine Interface (HMI)
- Uploads and downloads of application and drive software, with the power on or off

#### Safety functions

The Altivar 32 drive software includes three safety functions which contribute to ensuring machines meet safety requirements, whether or not they are used in conjunction with a Preventa safety module (2):

- STO: Safe Torque Off
- SLS: Safely Limited Speed
- SS1: Safe Stop 1

These safety functions are configured via the SoMove setup software (see page 28).

**Note:** To set up the safety functions, please refer to the “Safety Integrated function” manual, which is available on our website at [www.schneider-electric.com](http://www.schneider-electric.com).

#### ATV Logic

The integrated control system functions featuring ATV Logic can be used to perform simple operations without adding further devices.

ATV Logic is programmed via the SoMove setup software (see page 28) and provides access to the following functions:

- Arithmetical operations, Boolean operators, counters, timers, etc.
- Programming of up to 50 functions by an automated sequence
- Access to the drive’s internal variables

#### Motor control profiles for asynchronous and synchronous motors

The drive features different motor control profiles:

- For asynchronous motors:
  - Two voltage/frequency ratios: U/f and 5-point U/f
  - Sensorless flux vector control ratio
  - Kn<sup>2</sup> quadratic ratio (pump/fan)
  - Energy saving ratio
- For synchronous motors: Permanent Magnet motor control profile



Example of an application requiring a typical ATV Logic sequence

#### Examples of use (functions/applications)

Functions	Applications				
	Handling	Conveying	Packing	Wood-working machinery	Metal processing
Safety functions					
Communication buses and networks					
Fast response time					
Control profile for synchronous motors					
Application-specific functions					
		Typical use			Not applicable

(1) Non-exhaustive list; please consult our website [www.schneider-electric.com](http://www.schneider-electric.com).  
 (2) Please refer to the “Safety functions and solutions using Preventa” catalogue.



ATV 32H018M2...H075M2  
ATV 32H037N4...HU15N4



ATV 32HU11M2...HU22M2  
ATV 32HU22N4...HU40N4

### The offer

The Altivar 32 range of variable speed drives covers motor power ratings from 0.18 kW to 15 kW with two types of power supply:

- 200 V...240 V single-phase, 0.18 kW to 2.2 kW (**ATV 32H●●●M2**)
- 380 V...500 V three-phase, 0.37 kW to 15 kW (**ATV 32H●●●N4**)

Several drives can be mounted side by side to save space.

The Altivar 32 drive integrates the Modbus and CANopen communication protocols as standard. They can be accessed via the RJ45 connector on the front of the drive. To simplify connection of the Altivar 32 drive to the CANopen machine bus, three dedicated communication cards are available with different connectors:

- CANopen daisy chain card with two RJ 45 connectors
- CANopen card with 9-way SUB-D connector
- CANopen card with 5-way terminal block

See pages 24 and 25.

In addition to the Modbus and CANopen protocols which can be accessed as standard, the Altivar 32 drive can be connected to the main industrial communication buses and networks by adding one of the communication cards available as an option:

- Modbus/TCP - Ethernet/IP serial link
- PROFIBUS DP V1, DeviceNet
- EtherCAT (▲)

See page 22.

### Electromagnetic compatibility (EMC)

The built-in EMC filters in **ATV 32H●●●M2** and **ATV 32H●●●N4** drives and compliance with EMC requirements simplify installation and provide a very economical means of ensuring devices meet the criteria to receive the CE mark. This enables compliance with standard IEC 61800-3, category C2 for a maximum motor cable length of 10 metres.

This filter can be disconnected via a jumper.

Filters are available as an option and can be installed by the customer to reduce the level of emissions from Altivar 32 drives.

In particular, they allow use of a maximum motor cable length of 50 metres.

See page 20.

### External accessories and options

External accessories and options can be used with the Altivar 32 drive. The availability of external accessories and options depends on the drive rating.

#### Accessories

- Bracket for direct mounting of GV2/ATV 32 circuit-breaker (see page 32)
  - Adaptor for mounting the control module at 90°, for mounting the power module on its side, keeping the control module visible and accessible
  - Daisy chain DC bus cordsets for daisy chain connection of the DC bus
- See page 13.

#### External options

- Braking resistors
  - Line chokes
  - Motor chokes
  - Additional EMC filters
- See pages 17 to 21.



CANopen communication card with RJ45 connectors



CANopen communication card with SUB-D connector



CANopen communication card with connection via terminals



GV2/ATV 32 direct mounting

▲ Available third quarter 2010

References:  
page 12

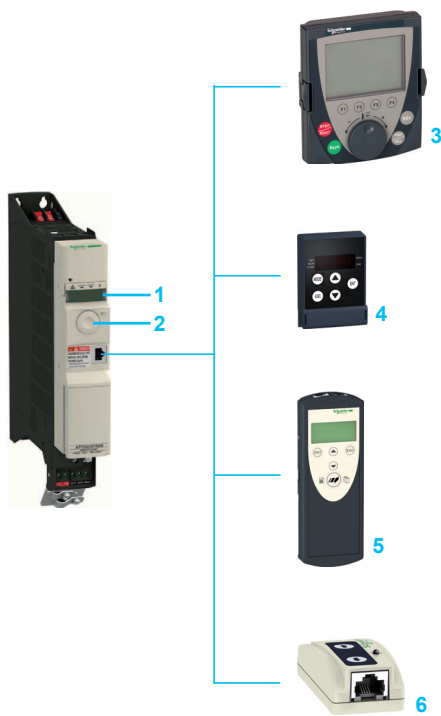

### The offer (continued)

#### Dialogue and configuration tools

##### Human-Machine interface

The 4-digit display **1** displays drive states, faults and parameter values. The navigation button **2** is used to navigate through the menus, modify values and change the motor speed in local mode.

##### HMI terminals

The Altivar 32 drive can be connected to a remote display terminal **4** or a remote graphic display terminal **3**, which are available as options.

The remote terminal can be mounted on an enclosure door with IP 54 or IP 65 degree of protection. It provides access to the same functions as the Human-Machine interface.

The remote graphic display terminal, with its text display in the user's language, provides a user-friendly interface for configuration, debugging or maintenance. It can also be mounted on an enclosure door with IP 54 or IP 65 degree of protection. See page 14.

##### SoMove setup software

The SoMove setup software is used to configure, adjust, debug (using the Oscilloscope function) and maintain the Altivar 32 drive in the same way as for all other Schneider Electric drives and starters.

It can be used with a direct connection or a Bluetooth® wireless connection. See page 28.

##### SoMove Mobile software for mobile phones

The SoMove Mobile software is used to edit the drive parameters from a mobile phone via a Bluetooth® wireless connection.

It can also be used to save configurations. These configurations can be imported or exported from a PC via a Bluetooth® wireless connection. See page 16.

##### Simple Loader and Multi-Loader configuration tools

The Simple Loader tool **6** enables the configuration from one powered-up drive to be duplicated on another powered-up drive.

The Multi-Loader tool **5** enables configurations from a PC or drive to be copied and duplicated on another drive; the drives do not need to be powered up. See page 16.

### Description

**1 to 6**, see "Dialogue and configuration tools" above.

**7** Power terminals

**8** Protective cover to prevent access to the power terminals **7** when closed

**9** RJ 45 communication port for access to integrated protocols: Modbus serial link and CANopen machine bus

**10** Protective cover for access to the control terminals (also includes a label with a wiring diagram)

**11** Removable motor power terminal block (allows the connection memory to be retained during maintenance operations)

**12** EMC mounting plate (integral part of the motor power terminal block **11**). This plate is supplied with a cable guide support, which can be fitted if required.

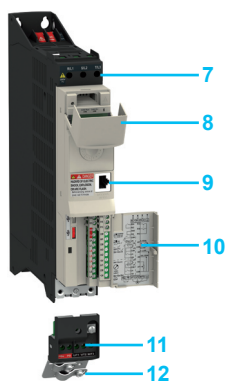

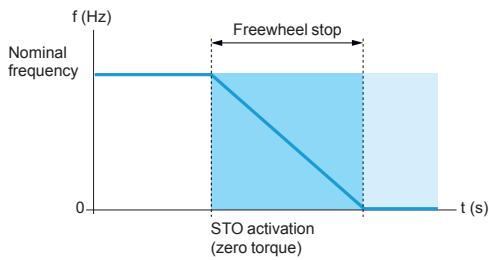

Activation of the STO safety function

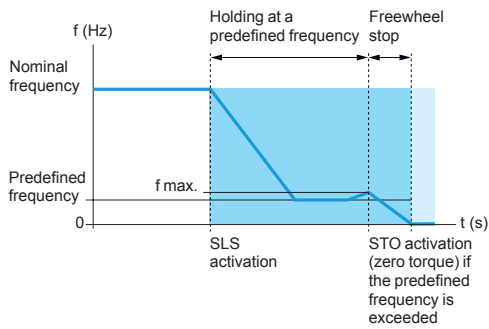

Activation of the SLS safety function

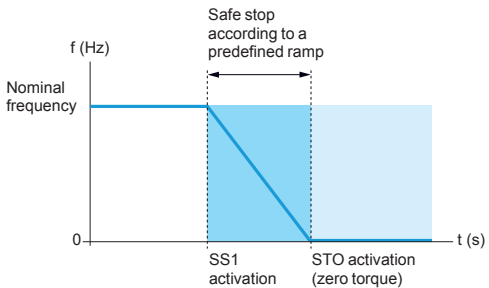

Activation of the SS1 safety function

### Integrated safety functions (1)

The Altivar 32 drive includes three safety functions:

- STO: Safe Torque Off
- SLS: Safely Limited Speed
- SS1: Safe Stop 1

These three functions are certified in accordance with IEC 61800-5-2 Ed.1 “Adjustable speed electrical power drive systems - Part 5-2: Safety requirements - Functional”.

This integration makes it possible to:

- Simplify setup of machines which require a complex safety device
- Improve performance during maintenance by reducing machine or installation downtimes and increase the safety of any work carried out

*Note: Some applications may require the addition of external Preventa safety modules (2).*

### Safe Torque Off (STO) safety function (1)

The STO integrated safety function causes a motor freewheel stop by eliminating the torque on the motor shaft.

### Safely Limited Speed (SLS) safety function (1)

The SLS integrated safety function slows down then holds the motor at a predefined frequency. If this predefined frequency cannot be held above a certain value, for example in the case of a driving load, the STO function is activated.

### Safe Stop 1 (SS1) safety function (1)

The SS1 integrated safety function causes a category 1 safe stop. This stop occurs in the following sequence:

- The motor is stopped according to a predefined deceleration ramp.
- A check is made to ensure that the motor has stopped or that the frequency has been reached.
- The STO function is activated.

### Setting up the integrated safety functions (1)

Setting up the integrated safety functions in the Altivar 32 drive does not require any options or additional accessories.

The functions are connected directly to the drive's logic inputs and can be configured using the SoMove setup software (see page 28).

(1) Please refer to the “Safety Integrated function” manual, which is available on our website at [www.schneider-electric.com](http://www.schneider-electric.com).

(2) Please refer to the “Safety functions and solutions using Preventa” catalogue.

### Standards and certifications <sup>(1)</sup>

Altivar 32 drives have been developed to conform to the strictest international standards and recommendations relating to industrial electrical control devices (IEC), in particular:

- IEC 61800-5-1
- IEC 61800-3:
  - EMC immunity: IEC 61800-3, Environments 1 and 2
  - Conducted and radiated EMC emissions: IEC 61800-3, category C2
- ISO/EN 13849-1/-2 category 3(PL d)
- IEC 61508 (parts 1 & 2)

Altivar 32 drives are certified:

- UL 508c
- CSA
- NOM
- GOST
- C-Tick

They are CE marked according to the European low voltage (2006/95/EC) and EMC (2004/108/EC) directives.

They also comply with environmental directives (RoHS).

*(1) Complete list of certifications and characteristics available on our website "[www.schneider-electric.com](http://www.schneider-electric.com)"*

# Variable speed drives

## Altivar 32

### Drives



ATV 32H018M2...H075M2  
ATV 32H037N4...HU15N4



ATV 32HU11M2...HU22M2  
ATV 32HU22N4...HU40N4



ATV 32HU55N4, HU75N4  
EMC plate not mounted



ATV 32HD11N4, HD15N4  
EMC plate not mounted

Drives (frequency range from 0.1 to 599 Hz)										
Motor		Line supply				Altivar 32			Reference	Weight
Power indicated on rating plate		Max. line current (1), (2)		Apparent power	Max. prospective line Isc (3)	Max. continuous output current (In) (4)	Maximum transient current for 60 s	Power dissipated at maximum output current (In) (4)		
		at U1	at U2	at U2		at U2		W		
kW	HP	A	A	kVA	kA	A	A	W		kg
Single-phase supply voltage: 200...240 V 50/60 Hz, with integrated EMC filter (2) (5) (6)										
0.18	1/4	3.4	2.8	0.7	1	1.5	2.3	25	ATV 32H018M2	2.400
0.37	1/2	6	5	1.2	1	3.3	5	38	ATV 32H037M2	2.400
0.55	3/4	7.9	6.7	1.6	1	3.7	5.6	42	ATV 32H055M2	2.400
0.75	1	10.1	8.5	2	1	4.8	7.2	51	ATV 32H075M2	2.400
1.1	1 1/2	13.6	11.5	2.8	1	6.9	10.4	64	ATV 32HU11M2	2.900
1.5	2	17.6	14.8	3.6	1	8	12	81	ATV 32HU15M2	2.900
2.2	3	23.9	20.1	4.8	1	11	16.5	102	ATV 32HU22M2	2.900
Three-phase supply voltage: 380...500 V 50/60 Hz, with integrated EMC filter (2) (5) (6)										
0.37	1/2	2.1	1.6	1.4	5	1.5	2.3	27	ATV 32H037N4	2.500
0.55	3/4	2.8	2.2	1.9	5	1.9	2.9	31	ATV 32H055N4	2.500
0.75	1	3.6	2.7	2.3	5	2.3	3.5	37	ATV 32H075N4	2.500
1.1	1 1/2	5	3.8	3.3	5	3	4.5	50	ATV 32HU11N4	2.500
1.5	2	6.5	4.9	4.2	5	4.1	6.2	63	ATV 32HU15N4	2.500
2.2	3	8.7	6.6	5.7	5	5.5	8.3	78	ATV 32HU22N4	3.000
3	–	11.1	8.4	7.3	5	7.1	10.7	100	ATV 32HU30N4	3.000
4	5	13.7	10.5	9.1	5	9.5	14.3	125	ATV 32HU40N4	3.000
5.5	7 1/2	20.7	14.5	17.9	22	14.3	21.5	233	ATV 32HU55N4	7.500
7.5	10	26.5	18.7	22.9	22	17	25.5	263	ATV 32HU75N4	7.500
11	15	36.6	25.6	31.7	22	27.7	41.6	403	ATV 32HD11N4	8.700
15	20	47.3	33.3	41	22	33	49.5	480	ATV 32HD15N4	8.800

Dimensions (overall)		
Drives	L x H x D	
	EMC plate mounted	EMC plate not mounted
	mm	mm
ATV 32H018M2...H075M2, ATV 32H037N4...HU15N4	45 x 317 x 245	– (6)
ATV 32HU11M2...HU22M2, ATV 32HU22N4...HU40N4	60 x 317 x 245	– (6)
ATV 32HU55N4, HU75N4	150 x 308 x 232	150 x 232 x 232
ATV 32HD11N4, HD15N4	180 x 404 x 232	180 x 330 x 232

(1) Typical value for a 4-pole motor and a maximum switching frequency of 4 kHz, with no line choke for max. prospective line Isc (3).  
 (2) Nominal supply voltage, min. U1, max. U2: 200 (U1)...240 V (U2), 380 (U1)...500 V (U2).  
 (3) If line Isc is greater than the values in the table, add line chokes (see page 18).  
 (4) These values are given for a nominal switching frequency of 4 kHz, for use in continuous operation. The switching frequency is adjustable from 2 to 16 kHz. Above 4 kHz, derate the nominal drive current. The nominal motor current should not exceed this value. See the derating curves on our website [www.schneider-electric.com](http://www.schneider-electric.com).  
 (5) Drives supplied with category C2 integrated EMC filter. This filter can be disconnected.  
 (6) Connection in compliance with EMC standards:  
 - ATV 32H●●M2, ATV 32H037N4...HU40N4 drives are supplied with an EMC plate. This is an integral part of the power terminals; these 2 components cannot be separated.  
 - ATV 32HU55N4...HD15N4 drives are supplied with an EMC plate, for assembly by the customer.

PF095123

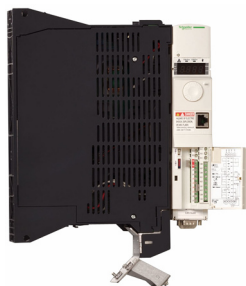

ATV 32HU15N4 with control module mounted at 90°

## Accessories

### Components for mounting GV2 circuit-breaker directly on ATV 32 drive

Description	For drives	Sold in lots of	Unit reference	Weight kg
<b>Bracket for GV2/ATV 32 direct mounting</b> Mechanical bracket for holding the GV2 circuit-breaker in place when directly mounted on ATV 32 drive. Requires a GV2 AF4 adaptor plate for electrical connection, to be ordered separately.	ATV 32H●●●M2 ATV 32H037N4...HU40N4	10	VW3 A9 921	0.075
<b>Adaptor plate</b> Provides the electrical link between the GV2 circuit-breaker and ATV 32 drive when GV2/ATV 32 directly mounted. Requires a VW3 A9 921 bracket for direct mounting, to be ordered separately.	ATV 32H●●●M2 ATV 32H037N4...HU40N4	10	GV2 AF4	0.016

### Mounting the control module at 90°

Description	For drives	Reference	Weight kg
<b>Adaptor for mounting the control module at 90°</b> This is used to mount the power module on the side, keeping the control module visible and accessible	ATV 32H●●●M2 ATV 32H037N4...HU40N4	VW3 A9 920	0.125

### Daisy Chain connection of the DC bus (1)

The DC bus is connected in a Daisy Chain in the following cases:

- Drives powered by the AC supply with parallel connection of the DC bus in order to balance the loads during braking phases between the drives; used in addition to braking resistors (see page 17)
- Drives powered by the DC bus only

Requires the cordsets listed below:

Description	Use	For drives		Length m	Reference	Weight kg
		From	To			
<b>Daisy chain DC bus cordsets (1)</b>	Fitted with 2 connectors	ATV 32H●●●M2	ATV 32H●●●M2	0.18	VW3 M7 101 R01	–
		ATV 32H037N4...HU40N4	ATV 32H037N4...HU40N4			
	Fitted with one connector and flying leads at one end	ATV 32H037N4...HU40N4	ATV 32HU55N4...HD15N4	1.5	VW3 M7 102 R15	–
	Fitted with 2 connectors	ATV 32H●●●M2 ATV 32H●●●N4	LEX 32●●●●M2 (2) LEX 32●●●●N4 (2)	0.65	VW3 M7 101 R06	–

## Documentation

Description	Reference	Weight kg
<b>"Description of the Motion &amp; Drives offer" DVD-ROM</b> Comprises (3): ■ Technical documentation (programming manuals, installation manuals, quick reference guides) ■ Catalogues ■ Brochures	VW3 A8 200	0.100

(1) Setting up several devices on the DC bus requires special precautions, please refer to the installation manual which is available on our website at [www.schneider-electric.com](http://www.schneider-electric.com).

(2) Lexium 32 motion control offer. See page 4 and please refer to our "Lexium 32 motion control" catalogue.

(3) The contents of this DVD-ROM are also available on our website [www.schneider-electric.com](http://www.schneider-electric.com).

PF095121



ATV 32H●●●M2 connected with a Daisy Chain DC bus cordset



Remote display terminal with cover open



Remote display terminal with cover closed



Remote graphic display terminal

### Remote display terminal

This terminal is used to locate the Human-Machine Interface of the Altivar 32 drive remotely on the door of an enclosure with IP 54 or IP 65 protection.

It is used to:

- Control, adjust and configure the drive remotely
  - Display the drive status and faults remotely
- Its maximum operating temperature is 50°C.

### Description

- 1 4-digit display
- 2 Navigation ▲, ▼ and selection ENT, ESC keys
- 3 Motor local control keys:
  - RUN: Starts the motor
  - FWD/REV: Reverses the direction of rotation of the motor
  - STOP/RESET : Stops the motor/resets drive faults
- 4 Operating mode selection key MODE
- 5 Cover controlling access to the motor local control keys

### References

Designation	Degree of protection	Length	Reference	Weight
				kg
<b>Remote display terminals</b>	IP 54	–	<b>VW3 A1 006</b>	0.250
A remote-mounting cordset	IP 65	–	<b>VW3 A1 007</b>	0.275
<b>Remote-mounting cordsets</b> fitted with 2 RJ45 connectors		1	<b>VW3 A1 104 R10</b>	0.050
		3	<b>VW3 A1 104 R30</b>	0.150

### Remote graphic display terminal

This graphic display terminal, common to all Schneider Electric's variable speed drive ranges, provides a user-friendly interface for configuration, debugging and maintenance. In particular, it is possible to transfer and store up to 4 configurations. For portable use or mounted on an enclosure door, it can also be connected to a number of drives (see page 15).

Its main functions are as follows:

- The graphic screen displays 8 lines of 24 characters of plain text.
- The navigation button provides quick and easy access to the drop-down menus.
- It is supplied with six languages installed (Chinese, English, French, German, Italian and Spanish). The available languages can be modified using the Multi-Loader configuration tool (VW3 A8 121).

Its maximum operating temperature is 60°C, and it features IP 54 protection; this can be increased to IP 65 when mounted on an enclosure door.

### Description

- 6 Graphic display:
  - 8 lines of 24 characters, 240 x 160 pixels, large digit display
- 7 Function keys (not operational on the Altivar 32)
- 8 **Navigation button:**
  - Rotate ±: Goes to the next/previous line, increases/decreases the value
  - Press: Saves the current value (ENT)
- ESC key:** Aborts a value, a parameter or a menu to return to the previous selection
- 9 Motor local control keys:
  - RUN: Starts the motor
  - STOP/RESET : Stops the motor/resets drive faults
  - FWD/REV: Reverses the motor direction of rotation





Portable use of the portable graphic display terminal: 1 + 2 + 3

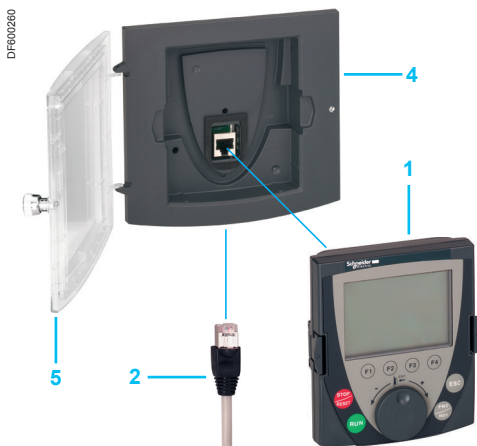

Using the graphic terminal in enclosure door: 1 + 2 + 4 (+ 5, if IP 65)

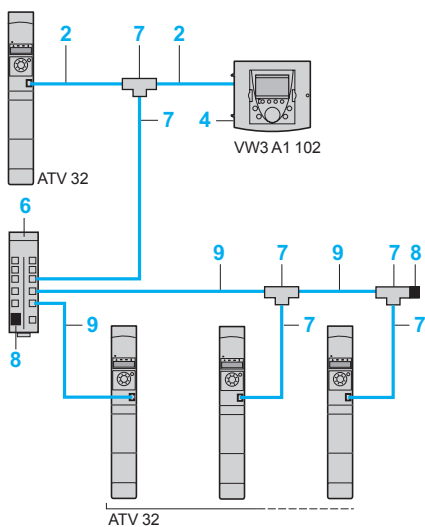

Example of connection via multidrop link

### Remote graphic display terminal (continued)

#### Accessories for mounting the graphic display terminal remotely

Description	Item no.	Length m	Reference	Weight kg
<b>Remote graphic display terminal</b> A remote-mounting cordset VW3 A1 104 R●●● and an RJ45 adaptor VW3 A1 105 must be provided	1	–	VW3 A1 101	0.180
<b>Remote-mounting cordsets</b> fitted with 2 RJ45 connectors For remote mounting of the Altivar 71 drive and graphic display terminal VW3 A1 101	2	1	VW3 A1 104 R10	0.050
	3	3	VW3 A1 104 R30	0.150
	5	5	VW3 A1 104 R50	0.250
	10	10	VW3 A1 104 R100	0.500
<b>Female/female RJ45 adaptor</b>	3	–	VW3 A1 105	0.010
<b>Remote mounting kit</b> For mounting on enclosure door IP 54 degree of protection	4	–	VW3 A1 102	0.150
<b>Door</b> Used to increase the degree of protection for remote mounting kit VW3 A1 102 to IP 65 To be mounted on remote mounting kit VW3 A1 102	5	–	VW3 A1 103	0.040

#### Additional accessories for multidrop connection

Description	Item no.	Sold in lots of	Unit reference	Weight kg
<b>Modbus splitter box</b> 10 RJ45 connectors and 1 screw terminal block	6	–	LU9 GC3	0.500
<b>Modbus T-junction boxes</b>	7	–	VW3 A8 306 TF03	–
	7	–	VW3 A8 306 TF10	–
<b>Modbus line terminator</b> For RJ45 connector	8	2	VW3 A8 306 RC	0.010

Description	Item no.	Length m	Reference	Weight kg
<b>Cordsets for Modbus serial link</b> equipped with 2 RJ45 connectors	9	0.3	VW3 A8 306 R03	0.025
	1	1	VW3 A8 306 R10	0.060
	3	3	VW3 A8 306 R30	0.130

#### Example of connection via multidrop link

All the components described on this page enable a graphic display terminal to be connected to several drives via a multidrop link. This multidrop link is connected to the RJ45 port on the Modbus/CANopen communication port. See the example opposite.



Configuration with SoMove Mobile software for mobile phones via Bluetooth®



VW3 A8 121



VW3 A8 120



Configuring an Altivar 32 in its packaging:  
VW3 A8 121 + VW3 A8 126 cordset

### SoMove Mobile software for mobile phones (1)

The SoMove Mobile software “transforms” any compatible mobile phone (1) into a remote graphic display terminal by offering an identical Human-Machine Interface (see page 14).

Particularly suitable for on-site or remote maintenance operations, the SoMove Mobile software can be used to print out and save configurations, import them from a PC and export them to a PC, or a drive, equipped with Bluetooth®.

The SoMove Mobile software and drive configuration files can be downloaded from our website [www.schneider-electric.com](http://www.schneider-electric.com).

### References

Description	For drives	Reference	Weight kg
<b>SoMove Mobile software for mobile phones (1)</b> Can be downloaded from our website <a href="http://www.schneider-electric.com">www.schneider-electric.com</a> .	ATV 32H●●●●●	–	–

### SoMove setup software

SoMove lite setup software for PC is used to prepare drive configuration files.

For presentation, description and references, see page 28.

### Simple Loader and Multi-Loader configuration tools

The Simple Loader tool enables one powered-up drive's configuration to be duplicated on another powered-up drive. It is connected to the drive's RJ45 communication port.

The Multi-Loader tool enables a number of configurations from a PC or drive to be copied and loaded onto another drive; the Altivar 32 drives do not need to be powered up.

### References

Description	For drives	Reference	Weight kg
<b>Simple Loader configuration tool</b> Supplied with a cordset fitted with 2 RJ45 connectors.	ATV 32H●●●●●	<b>VW3 A8 120</b>	–
<b>Multi-Loader configuration tool</b> Supplied with: - 1 cordset fitted with 2 RJ45 connectors - 1 cordset fitted with one type A USB connector and one mini B USB connector - 1 x SD memory card - 1 x female/female RJ 45 adaptor - 4 AA/LR6 1.5 V batteries - 1 anti-shock protection - 1 carrying handle	ATV 32H●●●●●	<b>VW3 A8 121</b>	–
<b>Cordset for Multi-Loader tool</b> For connecting the Multi-Loader tool to the Altivar 32 drive in its packaging. Fitted with a non-locking RJ45 connector with special mechanical catch on the drive end and an RJ45 connector on the Multi-Loader end.	ATV 32H●●●●● in its packaging	<b>VW3 A8 126</b>	–

(1) SoMove Mobile software requires a mobile phone with minimum features; please consult our website [www.schneider-electric.com](http://www.schneider-electric.com).

### Presentation

The braking resistor enables the Altivar 32 drive to operate while braking to a standstill or during slowdown braking, by dissipating the braking energy. It enables maximum transient braking torque.

Depending on the drive rating, two types of resistor are available:

- Enclosed model (IP 20 casing) designed to comply with the EMC standard and protected by a temperature-controlled switch or thermal overload relay.
- Enclosed model (IP 65 casing) with cordset, for ATV 32H●●●M2 and ATV 32H037N4...HU75N4 drives.

**Note:** To optimize the size of the braking resistor, the DC buses on Altivar 32 drives in the same application can be connected in parallel (see 13).

### Applications

Machines with high inertia, driving loads and machines with fast cycles.

### References

For drives	Minimum value of the resistor to be connected	Ohmic value	Average power available at 50°C (1)	Length of connection cable	Reference	Weight
	Ω	Ω	W	m		kg
<b>IP 65 braking resistors</b>						
ATV 32H018M2...H075M2	40	100	25	0.75	<b>VW3 A7 608 R07</b>	0.410
ATV 32H037...H075N4	80			3	<b>VW3 A7 608 R30</b>	0.760
ATV 32HU11N4...HU22N4	54					
ATV 32HU11M2, HU15M2	27	72	25	0.75	<b>VW3 A7 605 R07</b>	0.620
				3	<b>VW3 A7 605 R30</b>	0.850
ATV 32HU22M2	25	27	50	0.75	<b>VW3 A7 603 R07</b>	0.930
				3	<b>VW3 A7 603 R30</b>	1.200
ATV 32HU30N4	54	72	50	0.75	<b>VW3 A7 606 R07</b>	0.930
ATV 32HU40N4	36			3	<b>VW3 A7 606 R30</b>	1.200
ATV 32HU55N4, HU75N4	27	27	100	0.75	<b>VW3 A7 604 R07</b>	1.420
				3	<b>VW3 A7 604 R30</b>	1.620
<b>IP 20 braking resistors</b>						
ATV 32H018M2...H075M2	40	100	50	–	<b>VW3 A7 701</b>	2.000
ATV 32HU11M2, HU15M2	27					
ATV 32H037N4...H075N4	80					
ATV 32HU11N4...HU30N4	54					
ATV 32HU40N4	36					
ATV 32HU22M2	25	60	100	–	<b>VW3 A7 702</b>	2.400
ATV 32HU55N4, HU75N4	27					
ATV 32HD11N4, HD15N4	16	28	200	–	<b>VW3 A7 703</b>	3.500

(1) Load factor for resistors: the value of the average power that can be dissipated at 50°C from the resistor into the casing is determined for a load factor during braking that corresponds to the majority of normal applications:  
 - 2 s braking with a 0.6 Tn braking torque for a 40 s cycle  
 - 0.8 s braking with a 1.5 Tn braking torque for a 40 s cycle



VW3 A7 608 R●●



VW3 A7 701

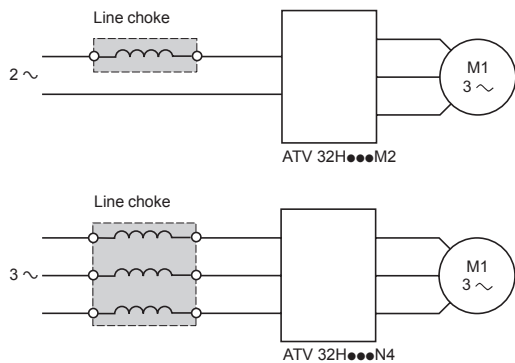

### Presentation

Line chokes provide improved protection against overvoltages on the line supply and reduce harmonic distortion of the current produced by the drive.

The recommended chokes limit the line current. They have been developed in line with standard IEC 61800-5-1 (VDE 0160 level 1 high-energy overvoltages on the line supply).

The inductance values are defined for a voltage drop between 3% and 5% of the nominal line voltage. Values higher than this will cause loss of torque.

The use of line chokes is recommended in particular under the following circumstances:

- Line supply with significant disturbance from other equipment (interference, overvoltages)
- Line supply with voltage imbalance between phases > 1.8% of nominal voltage
- Drive supplied by a line with very low impedance (in the vicinity of a power transformer 10 times more powerful than the drive rating)
- Installation of a large number of frequency inverters on the same line
- Reduction of overloads on the  $\cos \phi$  correction capacitors, if the installation includes a power factor correction unit

The prospective short-circuit current at the point of connection of the drive must not exceed the maximum value indicated in the reference tables (see page 12). The use of chokes allows connection to the following line supplies:

- Max. I<sub>sc</sub> 22 kA for 200/240 V
- Max. I<sub>sc</sub> 65 kA for 380/500 V

### References

Drive Reference	Line current				Choke Reference	Weight kg
	without choke		with choke			
	U min. (1) A	U max. (1) A	U min. (1) A	U max. (1) A		
<b>Single-phase supply voltage: 200...240 V 50/60 Hz</b>						
ATV 32H018M2	3.0	2.5	2.1	1.8	VZ1 L004M010	0.630
ATV 32H037M2	5.3	4.4	3.9	3.3		
ATV 32H055M2	6.8	5.8	5.2	4.3	VZ1 L007UM50	0.880
ATV 32H075M2	8.9	7.5	7.0	5.9		
ATV 32HU11M2	12.1	10.2	10.2	8.6	VZ1 L018UM20	1.990
ATV 32HU15M2	15.8	13.3	13.4	11.4		
ATV 32HU22M2	21.9	18.4	19.2	16.1		
<b>Three-phase supply voltage: 380...500 V 50/60 Hz</b>						
ATV 32H037N4	2.2	1.7	1.1	0.9	VW3 A4 551	1.500
ATV 32H055N4	2.8	2.2	1.4	1.2		
ATV 32H075N4	3.6	2.7	1.8	1.5		
ATV 32HU11N4	4.9	3.7	2.6	2		
ATV 32HU15N4	6.4	4.8	3.4	2.6		
ATV 32HU22N4	8.9	6.7	5	4.1	VW3 A4 552	3.000
ATV 32HU30N4	10.9	8.3	6.5	5.2		
ATV 32HU40N4	13.9	10.6	8.5	6.6		
ATV 32HU55N4	21.9	16.5	11.7	9.3	VW3 A4 553	3.500
ATV 32HU75N4	27.7	21	15.4	12.1		
ATV 32HD11N4	37.2	28.4	22.5	18.1	VW3 A4 554	6.000
ATV 32HD15N4	48.2	36.8	29.6	23.3		

(1) Nominal supply voltage:

For drives	Nominal voltage	
	U min.	U max.
ATV 32H...M2	200	240
ATV 32H...N4	380	500

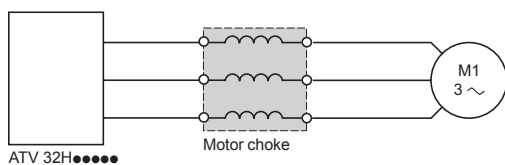

### Presentation

Motor chokes can be inserted between the Altivar 32 drive and the motor to:

- Limit the dv/dt at the motor terminals (500 to 1500 V/μs), for cables longer than 50 m
- Filter interference caused by opening of a contactor placed between the filter and the motor
- Reduce the motor earth leakage current
- Minimizing the current wave, thus reducing motor noise

### References (1)

For drives	Losses	Cable length (2)		Nominal current	Reference	Weight
		Shielded cable	Unshielded cable			
	W	m	m	A		kg
<b>Single-phase supply voltage: 200...240 V 50/60 Hz</b>						
ATV 32HU22M2	75	≤ 100	≤ 200	16	<b>VW3 A4 553</b>	3.500
<b>Three-phase supply voltage: 380...500 V 50/60 Hz</b>						
ATV 32HU22N4... HU40N4	65	≤ 100	≤ 200	10	<b>VW3 A4 552</b>	3.000
ATV 32HU55N4	75	≤ 100	≤ 200	16	<b>VW3 A4 553</b>	3.500
ATV 32HU75N4, HD11N4	90	≤ 100	≤ 200	30	<b>VW3 A4 554</b>	6.000
ATV 32HD15N4	80	≤ 100	≤ 200	60	<b>VW3 A4 555</b>	11.000

(1) For ATV 32H018M2...HU15M2 and ATV 32H037N4...HU15N4 drives, contact our Customer Care Centre.

(2) For an application with several motors connected in parallel, the cable length must take account of all the tap links. If a cable longer than that recommended is used, the filters may overheat.

# Variable speed drives

## Altivar 32

Integrated EMC filters and additional EMC input filters

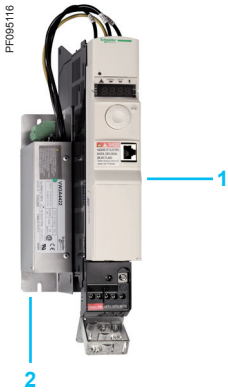

VW3 A4 422 + ATV 32HU11N4

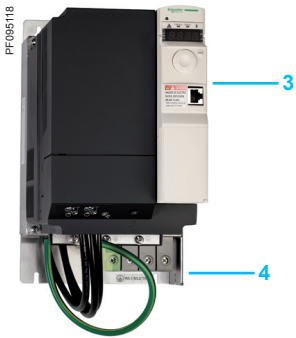

VW3 A4 424 + ATV 32HU55N4

### Presentation

#### Integrated filters

The Altivar 32 drive has integrated radio interference input filters to comply with the EMC (Electromagnetic Compatibility) standard for variable speed electrical power drive products IEC 61800-3 category C2 and the European EMC Directive.

#### Additional EMC input filters

The additional EMC input filters enable the drives to meet more stringent requirements; they are designed to reduce conducted emissions on the line supply below the limits of standard IEC 61800-3 category C1 or C2 (see page 21).

#### Mounting

Depending on the model, the additional EMC filters can be mounted beside or underneath the drive.

They act as a support for the drives and are attached to them via tapped holes.

#### Mounting the filter on the side of the drive:

- 1 ATV 32H●●●M2, ATV 32H037N4...HU40N4 drives
- 2 Additional EMC input filters

#### Mounting the filter underneath the drive:

- 3 ATV 32HU55N4...HD15N4 drives
- 4 Additional EMC input filters

#### Use according to the type of line supply

Additional EMC filters can only be used on TN (neutral connection) and TT (neutral to earth) type systems.

Standard IEC 61800-3, appendix D2.1, states that on IT systems (isolated or impedance earthed neutral), filters can cause permanent insulation monitors to operate in a random manner.

The effectiveness of additional filters on this type of system depends on the type of impedance between neutral and earth, and therefore cannot be predicted.

In the case of a machine which needs to be installed on an IT network, the solution would be to insert an isolation transformer and place the machine locally on a TN or TT network.

The radio interference input filters integrated in Altivar 32 drives can easily be disconnected by means of a selector switch without removing the drive.

PF095115



VW3 A4 422

PF06117

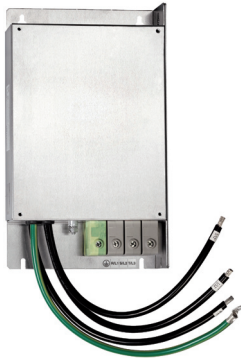

VW3 A4 424

Additional EMC input filters							
For drives	Additional EMC input filter						
Reference	Maximum length of shielded cable (1)	In (2)	Losses (3)	Mounting the filter/ATV 32	Reference	Weight	
IEC 61800-3 (4)							
Category C2		Category C1					
m		m		A	W	kg	
<b>Single-phase supply voltage: 200...240 V 50/60 Hz</b>							
ATV 32H018M2 ATV 32H037M2 ATV 32H055M2 ATV 32H075M2	50	20	10.1	3.7	On the side	<b>VW3 A4 420</b>	0.600
ATV 32HU11M2 ATV 32HU15M2	50	20	17.6	6.9	On the side	<b>VW3 A4 421</b>	0.775
ATV 32HU22M2	50	20	23.9	7.5	On the side	<b>VW3 A4 426</b>	1.130
<b>Three-phase supply voltage: 380...500 V 50/60 Hz</b>							
ATV 32H037N4 ATV 32H055N4 ATV 32H075N4 ATV 32HU11N4 ATV 32HU15N4	50	20	15	9.9	On the side	<b>VW3 A4 422</b>	0.900
ATV 32HU22N4 ATV 32HU30N4 ATV 32HU40N4	50	20	25	15.8	On the side	<b>VW3 A4 423</b>	1.350
ATV 32HU55N4 ATV 32HU75N4	50	20	47	19.3	Underneath	<b>VW3 A4 424</b>	3.150
ATV 32HD11N4 ATV 32HD15N4	50	20	49	27.4	Underneath	<b>VW3 A4 425</b>	4.750

(1) The filter selection tables give the maximum lengths for shielded cables connecting motors to drives. These maximum lengths are given as examples only, as they vary depending on the stray capacitance of the motors and the cables used. If motors are connected in parallel, it is the sum of the cable lengths that should be taken into account.

(2) In: nominal filter current.

(3) Via heat dissipation, at the nominal filter current (In).

(4) Standard IEC 61800-3: EMC immunity and conducted and radiated EMC emissions:

- Category C1: public power supply (residential)

- Category C2: industrial power supply

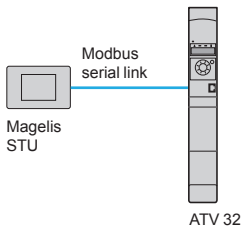

Example of configuration on Modbus serial link

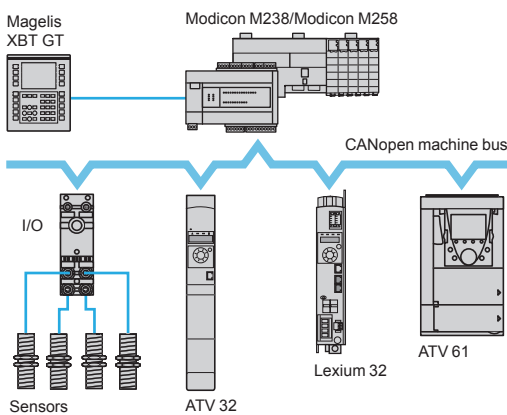

Example of configuration on CANOpen machine bus

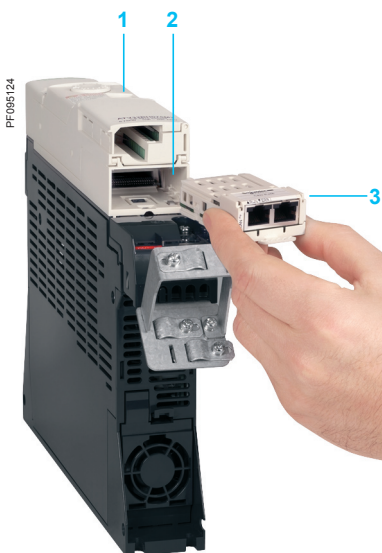

Example of installing a communication card 3 (view of underside)

### Presentation

The Altivar 32 drive is designed to meet the configuration requirements found in the main industrial communication installations.

It includes the Modbus and CANOpen communication protocols as standard. These can be accessed directly via the RJ45 communication port located on the front. The Altivar 32 drive can also be connected to other industrial communication buses and networks by using one of the communication cards available as an option. Communication cards are supplied in "cassette" format for ease of mounting/removal.

#### Modbus serial link (1)

The Modbus serial link is used for connecting dialogue and configuration tools:

- Magelis HMI terminal, etc.
- Remote display terminal, remote graphic display terminal, etc.
- SoMove setup software, Simple Loader and Multi-loader configuration tools, etc.

#### CANopen machine bus (1) (2) (3)

The CANOpen machine bus is used for integration into control system architectures, especially when combined with Modicon M238 and M258 logic controllers, Lexium 32 motion controllers, etc.

#### Optimized solutions for connection to the CANopen machine bus

To simplify setting up the Altivar 32 drive, three dedicated CANOpen (2) communication cards are available depending on the connection and connector types:

- CANOpen Daisy chain card with 2 RJ45 connectors offering an optimized solution for daisy chain connection to the CANOpen machine bus (see page 24)
- CANOpen card for connection to the bus via 9-way SUB-D connector (see page 24)
- CANOpen card for connection to the bus via terminals (see page 25)

Using one of the CANOpen communication cards also reduces the installation dimensions compared to using VW3 CAN TAP 2 and VW3 CAN TDM4 junction boxes.

#### Communication cards for industrial applications (3)

The following communication cards are available:

- Modbus TCP and EtherNet/IP network card
- PROFIBUS DP V1 card
- DeviceNet card
- EtherCAT card

### Description

The Altivar 32 drive has been designed to simplify connections to communication buses and networks with:

- 1 Integrated RJ45 communication port for Modbus/CANOpen on the front
- 2 Slot for the communication card
- 3 Communication card

(1) The Modbus serial link always uses the RJ45 communication port located on the front. If simultaneous use of the Modbus serial link and the CANOpen machine bus is required, a CANOpen communication card is needed.

(2) When one of the CANOpen communication cards is inserted in the Altivar 32 drive, CANOpen communication via the RJ45 communication port on the front is disabled.

(3) The Altivar 32 drive can only take one communication card.



#### Functions

All the Altivar 32 drive functions can be accessed via the communication buses and networks:

- Control
- Monitoring
- Adjustment
- Configuration

The speed reference and command may come from different sources:

- Logic input or analog I/O terminals
- Communication bus or network
- Remote display terminals

The Altivar 32 drive's advanced functions can be used to manage switching of these drive control sources according to the application requirements.

The communication periodic I/O data assignment can be selected using the network configuration software.

The Altivar 32 drive can be controlled:

- According to the CiA 402 native profile
- According to the I/O profile

Communication is monitored according to criteria specific to each protocol.

Regardless of protocol type, the reaction of the drive to a communication fault can be configured as follows:

- Freewheel stop, stop on ramp, fast stop or braked stop
- Maintain the last command received
- Fallback position at a predefined speed
- Ignore the fault

#### Modbus serial link (1)

##### Connection accessories for remote Human-Machine Interface (2)

Description	No.	Length m	Reference	Weight kg
Cordsets for Modbus serial link equipped with 2 RJ45 connectors	1	0.3	VW3 A8 306 R03	0.025
		1	VW3 A8 306 R10	0.060
		3	VW3 A8 306 R30	0.130

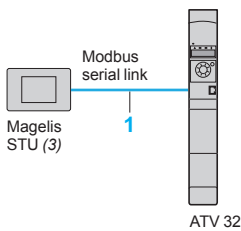

Example connection of an Altivar 32 drive and a Magelis STU HMI terminal via the Modbus serial link

(1) The Modbus serial link always uses the RJ45 communication port located on the front. If simultaneous use of the Modbus serial link and the CANopen machine bus is required, a CANopen communication card is needed.

(2) See page 14 for connection of a remote display terminal or remote graphic display terminal.

(3) Requires a 24 V  $\overline{\text{DC}}$  power supply. Please refer to the "Human/Machine interfaces" catalogue.

# Variable speed drives

## Altivar 32

### Communication buses and networks

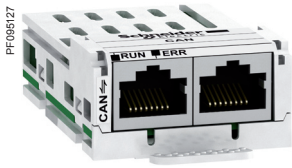

VW3 A3 608

Modicon M238/Modicon M258 (7)

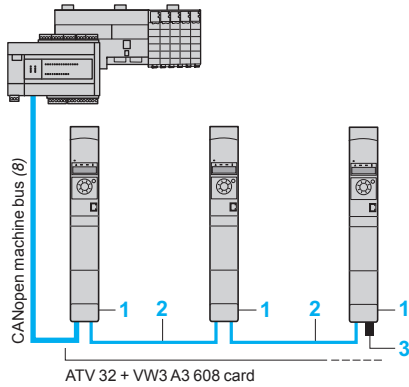

Optimized solution for daisy chain connection to the CANopen machine bus



VW3 A3 618

Modicon M238/Modicon M258 (7)

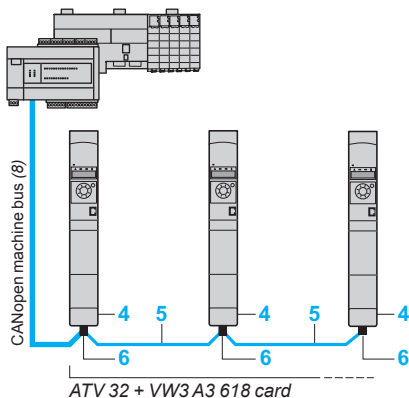

Example of connection to the CANopen machine bus via SUB-D connector

### CANopen machine bus (1)

Description	No.	Length m	Unit reference	Weight kg
<b>Connection with VW3 A3 608 CANopen Daisy chain card</b> (optimized solution for daisy chain connection to the CANopen machine bus)				
<b>CANopen Daisy chain communication card (2) (3)</b> Ports: 2 RJ45 connectors	1	–	<b>VW3 A3 608</b>	–

<b>CANopen cordsets</b> equipped with 2 RJ45 connectors	2	0.3	<b>VW3 CAN CARR03</b>	0.050
	1	1	<b>VW3 CAN CARR1</b>	0.500

<b>CANopen line terminator</b> for RJ45 connector (4)	3	–	<b>TCS CAR013M120</b>	–
--	---	---	-----------------------	---

### Connection via SUB-D connector with VW A3 618 CANopen card

<b>CANopen communication card (2) (3)</b> Port: 1 x 9-way male SUB-D connector	4	–	<b>VW3 A3 618</b>	–
---	---	---	-------------------	---

<b>CANopen cable</b> Standard cable, C€ marking Low smoke zero halogen Flame retardant (IEC 60332-1)	5	50	<b>TSX CAN CA 50</b>	4.930
		100	<b>TSX CAN CA 100</b>	8.800
		300	<b>TSX CAN CA 300</b>	24.560

<b>CANopen cable</b> Standard cable, UL certification, C€ marking Flame retardant (IEC 60332-2)	5	50	<b>TSX CAN CB 50</b>	3.580
		100	<b>TSX CAN CB 100</b>	7.840
		300	<b>TSX CAN CB 300</b>	21.870

<b>CANopen cable</b> Cable for harsh environments (5) or mobile installations, C€ marking Low smoke zero halogen Flame retardant (IEC 60332-1)	5	50	<b>TSX CAN CD 50</b>	3.510
		100	<b>TSX CAN CD 100</b>	7.770
		300	<b>TSX CAN CD 300</b>	21.700

<b>CANopen IP 20 straight connector</b> 9-way female SUB-D with line terminator which can be deactivated	6	–	<b>TSX CAN KCDF 180T</b>	0.049
--	---	---	--------------------------	-------

<b>IP 20 CANopen right angle connector</b> (6) 9-way female SUB-D with line terminator which can be deactivated	6	–	<b>TSX CAN KCDF 90T</b>	0.046
--	---	---	-------------------------	-------

(1) The Modbus serial link always uses the RJ45 communication port located on the front. If simultaneous use of the Modbus serial link and the CANopen machine bus is required, a CANopen communication card is needed.

(2) The Altivar 32 drive can only take one communication card.

(3) When one of the CANopen communication cards is inserted in the Altivar 32 drive, CANopen communication via the RJ45 communication port on the front is disabled.

(4) Order in multiples of 2.

(5) Standard environment:

- No particular environmental constraints
- Operating temperature between + 5°C and + 60°C
- Fixed installation

Harsh environment:

- Resistance to hydrocarbons, industrial oils, detergents, solder splashes
- Relative humidity up to 100%
- Saline atmosphere
- Operating temperature between - 10°C and + 70°C
- Significant temperature variations

(6) Incompatible with side-by-side mounting.

(7) Please refer to the "M238 logic controller" and "M258 logic controller" catalogues.

(8) Cable dependent on the type of controller or PLC; please refer to the corresponding catalogue.

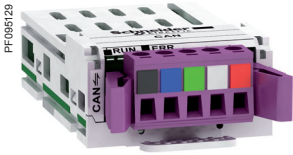

VW3 A3 628

Modicon M238/Modicon M258 (5)

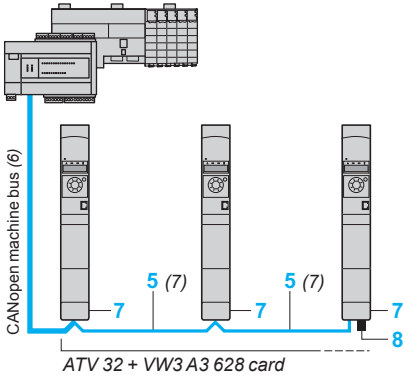

Example of connection to the CANopen machine bus via screw terminals

#### CANopen machine bus (continued) (1)

Description	No.	Length m	Unit reference	Weight kg
<b>Connection via terminals with VW3 A3 628 CANopen card</b>				
CANopen communication card (2) (3)	7	–	VW3 A3 628	–
Port: 1 5-way screw terminal block				

CANopen line terminator for screw terminal connector (4)	8	–	TCS CAR01NM120	–
--	---	---	----------------	---

#### Other connection accessories and cordsets

<b>IP 20 CANopen cordsets</b> equipped with two 9-way female SUB-D connectors. Standard cable, CE marking Low smoke zero halogen Flame retardant (IEC 60332-1)	–	0.3	TSX CAN CADD 03	0.091
	1		TSX CAN CADD 1	0.143
	3		TSX CAN CADD 3	0.295
	5		TSX CAN CADD 5	0.440
	–	–	–	–

<b>IP 20 CANopen cordsets</b> equipped with two 9-way female SUB-D connectors. Standard cable, UL certification, CE marking Flame retardant (IEC 60332-2)	–	0.3	TSX CAN CBDD 03	0.086
	1		TSX CAN CBDD 1	0.131
	3		TSX CAN CBDD 3	0.268
	5		TSX CAN CBDD 5	0.400
	–	–	–	–

<b>IP 20 CANopen junction boxes</b> equipped with: ■ 4 x 9-way male SUB-D connectors + screw terminal block for trunk cable tap link ■ Line terminator	–	–	TSX CAN TDM4	0.196
	–	–	–	–

<b>IP 20 CANopen junction boxes</b> equipped with: ■ 2 screw terminal blocks for trunk cable tap link ■ 2 RJ45 connectors for connecting drives ■ 1 RJ45 connector for connecting a PC	–	–	VW3 CAN TAP2	0.480
	–	–	–	–

(1) The Modbus serial link always uses the RJ45 communication port located on the front. If simultaneous use of the Modbus serial link and the CANopen machine bus is required, a CANopen communication card is needed.

(2) The Altivar 32 drive can only take one communication card.

(3) When one of the CANopen communication cards is inserted in the Altivar 32 drive, CANopen communication via the RJ45 communication port on the front is disabled.

(4) Order in multiples of 2.

(5) Please refer to the "M238 logic controller" and "M258 logic controller" catalogues.

(6) Cable dependent on the type of controller or PLC; please refer to the corresponding catalogue.

(7) See page 24 for item "5".

# Variable speed drives

## Altivar 32

### Communication buses and networks



VW3 A3 616

Modicon M340 (4)

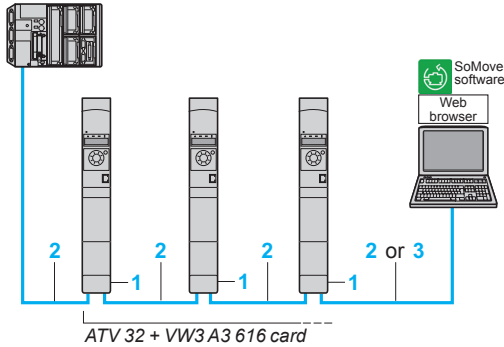

Example of connection on an EtherNet/IP network

#### Modbus TCP network and EtherNet/IP network (1)

Description	No.	Length m (3)	Reference	Weight kg
-------------	-----	--------------	-----------	-----------

#### Communication card

<b>Modbus TCP and EtherNet/IP network card</b>	1	–	VW3 A3 616	0.300
--	---	---	------------	-------

For connection to the Modbus TCP network or EtherNet/IP network  
 Ports: 2 RJ45 connectors  
 ■ 10/100 Mbps, half duplex and full duplex  
 ■ Embedded Web server

Requires cordsets  
 490 NTW 000 ●●/●●U or  
 490 NTC 000 ●●/●●U

#### ConneXium cordsets (2) (3)

<b>Straight shielded twisted pair cordsets</b>	2	2	490 NTW 000 02	–
--	---	---	----------------	---

equipped with 2 RJ45 connectors  
 Conforming to EIA/TIA-568 category 5 and IEC 11801/EN 50173-1, class D standards

<b>Crossed shielded twisted pair cordsets</b>	3	5	490 NTW 000 05	–
---	---	---	----------------	---

equipped with 2 RJ45 connectors  
 Conforming to EIA/TIA-568 category 5 and IEC 11801/EN 50173-1, class D standards

<b>Straight shielded twisted pair cordsets</b>	2	2	490 NTW 000 02U	–
--	---	---	-----------------	---

equipped with 2 RJ45 connectors  
 Conforming to UL and CSA 22.1 standards

<b>Crossed shielded twisted pair cordsets</b>	3	5	490 NTC 000 05U	–
---	---	---	-----------------	---

equipped with 2 RJ45 connectors  
 Conforming to UL and CSA 22.1 standards

(1) The Altivar 32 drive can only take one communication card.  
 (2) For other ConneXium connection accessories, please refer to our website at "www.schneider-electric.com".  
 (3) Also available in 40 and 80 metre lengths (2).  
 (4) Please refer to the "M340 Automation platform" catalogue.

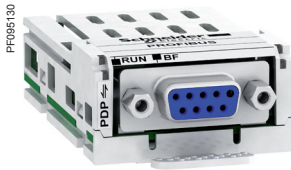

VW3 A3 607

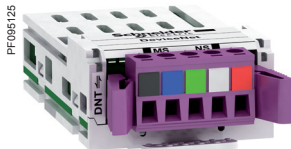

VW3 A3 609

#### PROFIBUS DP V1 bus (1)

Description	References	Weight kg
<b>PROFIBUS DP V1 communication card</b> Port: One 9-way female SUB-D connector Conforming to PROFIBUS DP V1 Profiles supported: ■ CiA 402 drive ■ Profidrive Offers several message handling modes based on DP V1	VW3 A3 607	0.140

#### DeviceNet bus (1)

Description	References	Weight kg
<b>DeviceNet communication card</b> Port: 1 removable 5-way screw connector Profiles supported: ■ CIP AC DRIVE ■ CiA 402 drive	VW3 A3 609	–

#### EtherCAT bus (1)

Description	References	Weight kg
<b>EtherCAT communication card</b> Port: 2 RJ45 connectors	VW3 A3 601 ▲	–

(1) The Altivar 32 drive can only take one communication card.

▲ Available third quarter 2010

Presentation:  
page 22

Functions:  
page 23

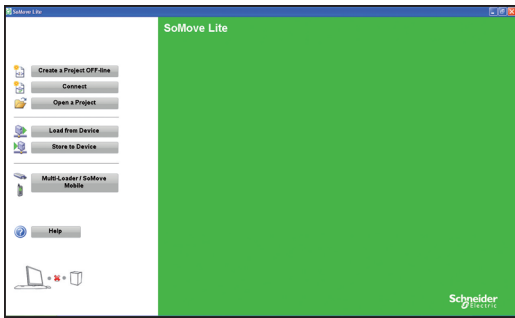

SoMove start page

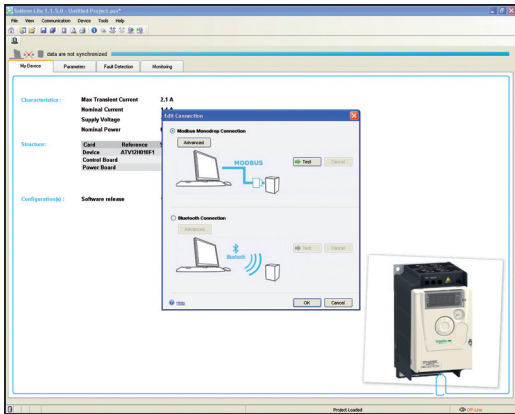

Example of connecting SoMove software to an ATV 12 drive

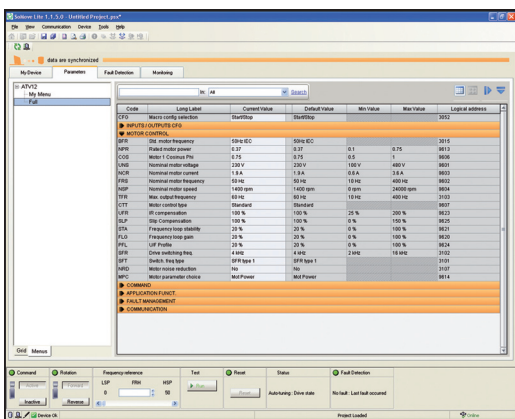

SoMove control panel

## Presentation

SoMove is user-friendly setup software for PCs, for setting up the following Schneider Electric motor control devices:

- ATV 12, ATV 312, ATV 31, ATV 32, ATV 61 and ATV 71 variable speed drives
- ATS 22 starters
- TeSys U starter-controllers
- TeSys T motor management system
- Lexium 32 servo drives

SoMove software incorporates various functions for the device setup phases, such as:

- Configuration preparation
- Start-up
- Maintenance

To facilitate setup and maintenance, SoMove software can use a direct USB/RJ45 cable link or a Bluetooth® wireless link.

SoMove software is also compatible with the Multi-Loader configuration tool and SoMove Mobile software for mobile phones.

These tools can save a significant amount of time when loading, duplicating or editing configurations on a device.

SoMove software and all the DTMs (Device Type Managers) associated with the devices can be downloaded from our website [www.schneider-electric.com](http://www.schneider-electric.com).

## Functions

### Configuration preparation in disconnected mode

SoMove software has a genuine disconnected mode which provides access to all the device parameters. This mode can be used to generate the device configuration. The configuration can be saved, printed and exported to office automation software.

SoMove software also checks the consistency of the parameters, validating the configurations created in disconnected mode.

A large number of functions are available in disconnected mode, in particular:

- The device configuration software wizard
- The configuration comparison function
- Saving, copying, printing and creating configuration files for export to Multi-Loader, SoMove Mobile or Microsoft Excel® and sending configurations by e-mail.

## Setup

When the PC is connected to the device, SoMove software can be used for:

- Transferring the configuration that has been generated onto the device
- Adjustment and monitoring. This includes such functions as:
  - The oscilloscope
  - Displaying communication parameters
- Easy control via the control panel user interface
- Saving the final configuration

## Maintenance

In order to simplify maintenance operations, SoMove software can be used to:

- Compare the configuration of a device currently being used with a configuration saved on the PC
- Transfer a configuration to a device
- Compare oscilloscope curves
- Save oscilloscope curves and faults

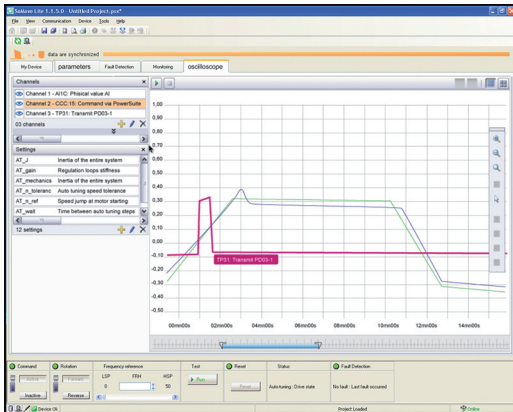

SoMove oscilloscope function

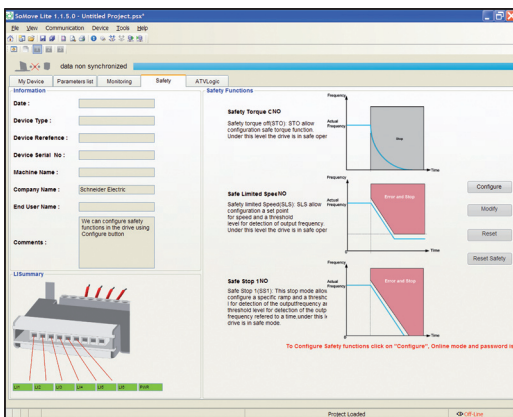

SoMove Safety function

## Functions (continued)

### User interface

SoMove software provides fast, direct access to all information on the device via five tabs:

- **My Device:** Displays all the information on the device (type, reference, software versions, option cards, etc.)
- **Parameters:** Displays all the device adjustment parameters, shown in a table or in the form of diagrams
- **Faults:** Displays a list of the faults that may be encountered with the device, the fault log and any current faults or alarms
- **Monitoring:** Provides a realtime display of the device status, its I/O and all the monitoring parameters. It is possible to create your own control panel by selecting your parameters and how they are to be represented.
- **Oscilloscope:** Provides a high-speed oscilloscope (recording traces in the device) or low-speed oscilloscope (recording traces in the software for devices that do not have an integrated oscilloscope)

SoMove's user interface automatically adapts to the specific configured device by offering additional tabs:

- **Safety:** For configuring the Safety functions on ATV 32 variable speed drives and Lexium 32 servo drives. It can also be used to:
  - Display the I/O
  - Compile and print a report
  - **ATVLogic:** For accessing the ATV 32 drive's programmable function blocks. It can also be used to:
    - Develop a program and transfer it to the drive
    - Display and debug the program already on the drive
    - **Auto-tuning:** For accessing the servo control settings for the three different operating modes of the Lexium 32 servo drive's auto-tuning function:
      - Automatic mode for quick setup, designed for simple applications
      - Semi-automatic mode for quick setup, with the option of optimizing the servo drive/servo motor combination (access to the mechanical and dynamic behaviour parameters)
      - Expert mode for optimizing the adjustment parameters, designed for complex applications

### Connections

#### Modbus serial link

The PC running SoMove software can be connected directly via the RJ45 connector on the device and the USB port on the PC using the USB/RJ45 cable.

See the product references on page 30.

#### Bluetooth® wireless link

SoMove software can communicate via Bluetooth® wireless link with any Bluetooth® enabled device.

If the device is not Bluetooth® enabled, use the Modbus-Bluetooth® adaptor. This adaptor is connected to the terminal port or the Modbus network port on the device. It has a 10 m range (class 2).

If the PC is not Bluetooth® enabled, use the USB-Bluetooth® adaptor.

See the product references on page 30.



SoMove setup software

PF080632



VW3 A8 114:  
Bluetooth® adaptor

## References

Description	Reference	Weight kg
<b>SoMove lite setup software</b> Comprising: <ul style="list-style-type: none"> <li>■ SoMove setup software for PC in English, French, German, Italian, Spanish and Chinese</li> <li>■ DTMs (Device Type Managers) and technical documentation for variable speed drives, starters and servo motors</li> </ul>	(1)	–
<b>USB/RJ45 cable</b> Used to connect a PC to the device. This cable is 2.5 m long, and has a USB connector (PC end) and an RJ45 connector (device end).	TCSM CNAM 3M002P	–
<b>Modbus-Bluetooth® adaptor</b> Used to enable any non-Bluetooth® device to communicate via Bluetooth® wireless link (2).  Comprising: <ul style="list-style-type: none"> <li>■ 1 Bluetooth® adaptor (range 10 m, class 2) with an RJ45 connector</li> <li>■ For SoMove: 1 x 0.1 m cable with 2 x RJ45 connectors</li> <li>■ For TwidoSuite: 1 x 0.1 m cable with 1 RJ45 connector and 1 mini DIN connector</li> </ul>	VW3 A8 114	0.155
<b>USB-Bluetooth® adaptor for PC</b> Used to enable any non-Bluetooth® PC to communicate via Bluetooth® wireless link (3). It connects to a USB port on the PC. Range 10 m (class 2)	VW3 A8 115	0.290

(1) Available on our website "[www.schneider-electric.com](http://www.schneider-electric.com)"

- (2) Required for the following devices:
- ATV 12, ATV 312, ATV 31, ATV 61 and ATV 71 drives
  - ATS 22 starters
  - TeSys U starter-controllers
  - TeSys T motor management system
  - Lexium 32 servo drives

(3) Check the manufacturer's specification.



### Compatibility of SoMove software with specific devices

Device	Range	Version of software on the device
Variable speed drive	ATV 12, ATV 312, ATV 32	≥ 1.0
	ATV 31	≥ 1.1
	ATV 61, ATV 71	≥ 1.6
Starter	ATS 22	≥ 1.0
Starter-controller	TeSys U	≥ 1.0
Motor management system	TeSys T	≥ 1.0
Servo drive	Lexium 32	≥ 1.0

### Environments

SoMove operates in the following PC environments and configurations:

- Microsoft Windows® 7 Professional
- Microsoft Windows® XP Professional SP3
- Microsoft Windows® Vista Business SP2
- Pentium IV (or equivalent), 1 GHz, hard disk with 1 GB available space, 512 MB of RAM (minimum configuration)

# Variable speed drives

## Altivar 32

### Motor starters: circuit-breaker + drive

#### Applications

The proposed combinations can protect people and equipment when a short-circuit occurs on the power stage.

Two types of combination are possible:

- Drive + circuit-breaker: minimum combination

The circuit-breaker can be mounted directly on ATV 32H●●M2 and ATV 32H037N4...HU40N4 drives using the bracket for GV2/ATV32 direct mounting (VW3 A9 921) and the adaptor plate (GV2 AF4) (see page 13).

- Drive + circuit-breaker + contactor: minimum combination with contactor when a control circuit is needed.

The circuit-breaker provides protection against accidental short-circuits, disconnection and, if necessary, isolation.

The contactor controls and manages any safety features. A contactor can be used downstream of the drive to ensure the motor is isolated on stopping. In this case, the contactor size should be category AC-3 depending on the associated motor, only for operation between 25 Hz and 500 Hz.

The Altivar 32 drive is protected electronically against short-circuits between phases and between phase and earth. It therefore ensures continuity of service and thermal protection of the motor.

PF09511



GV2/ATV 32 direct mounting:  
GV2 L08 + (VW A9 921 + GV2 AF4) (3)  
+  
ATV 32H075N4

#### Motor starters: circuit-breaker + drive

Standard power ratings of three-phase 4-pole 50/60 Hz motors (2)		Variable speed drive	Circuit-breaker (1)			
Reference		Reference	Rating	Maximum short-circuit current I <sub>cu</sub> at 415 V	Circuit-breaker mounted directly on ATV 32	
kW	HP		A	kA		
<b>Single-phase supply voltage: 200...240 V 50/60 Hz</b>						
0.18	1/4	ATV 32H018M2	GV2 L08	4	> 100	With accessories VW3 A9 921 + GV2 AF4 (3)
0.37	1/2	ATV 32H037M2	GV2 L10	6.3	> 100	
0.55	3/4	ATV 32H055M2	GV2 L14	10	> 100	
0.75	1	ATV 32H075M2	GV2 L16	14	> 100	
1.1	1 1/2	ATV 32HU11M2	GV2 L16	14	> 100	
1.5	2	ATV 32HU15M2	GV2 L20	18	> 100	
2.2	3	ATV 32HU22M2	GV2 L22	25	50	
<b>Three-phase supply voltage: 380...500 V 50/60 Hz</b>						
0.37	1/2	ATV 32H037N4	GV2 L07 (4)	2.5	> 100	With accessories VW3 A9 921 + GV2 AF4 (3)
0.55	3/4	ATV 32H055N4	GV2 L08 (4)	4	> 100	
0.75	1	ATV 32H075N4	GV2 L08 (4)	4	> 100	
1.1	1 1/2	ATV 32HU11N4	GV2 L10 (4)	6.3	> 100	
1.5	2	ATV 32HU15N4	GV2 L14 (4)	10	> 100	
2.2	3	ATV 32HU22N4	GV2 L14 (4)	10	> 100	
3	–	ATV 32HU30N4	GV2 L16 (4)	14	50	
4	5	ATV 32HU40N4	GV2 L16 (4)	14	50	
5.5	7 1/2	ATV 32HU55N4	GV2 L22	25	50	–
7.5	10	ATV 32HU75N4	GV2 L32	32	50	–
11	15	ATV 32HD11N4	GV3 L40	40	50	–
15	20	ATV 32HD15N4	GV3 L50	50	50	–

(1) GV2 L, GV3 L: TeSys magnetic motor circuit-breakers; accessories (see page 35).

(2) The HP values given are NEC-compliant (National Electrical Code).

(3) To be ordered separately (see page 13).

(4) A GV2 P TeSys thermal magnetic circuit-breaker with the same rating can also be used with ATV 32H037N4...HU40N4 drives. The thermal release should then be set to maximum to inhibit this function.

# Variable speed drives

## Altivar 32

Motor starters: circuit-breaker + contactor + drive



GV2 L14  
+  
LC1 D09  
+  
ATV 32HU15N4

### Motor starters: circuit-breaker + contactor + drive

Standard power rating of 50/60 Hz 4-pole motors (3)		Variable speed drive Reference	Circuit-breaker (1)			Contactor (2)
			Reference	Rating	Maximum short-circuit current Icu at 415 V	Reference (4)
kW	HP		A			
<b>Single-phase supply voltage: 200...240 V 50/60 Hz</b>						
0.18	1/4	ATV 32H018M2	GV2 L08	4	> 100	LC1 D09●●
0.37	1/2	ATV 32H037M2	GV2 L10	6.3	> 100	LC1 D09●●
0.55	3/4	ATV 32H055M2	GV2 L14	10	> 100	LC1 D09●●
0.75	1	ATV 32H075M2	GV2 L16	14	> 100	LC1 D09●●
1.1	1 1/2	ATV 32HU11M2	GV2 L16	14	> 100	LC1 D09●●
1.5	2	ATV 32HU15M2	GV2 L20	18	> 100	LC1 D09●●
2.2	3	ATV 32HU22M2	GV2 L22	25	50	LC1 D09●●

<b>Three-phase supply voltage: 380...500 V 50/60 Hz</b>						
0.37	1/2	ATV 32H037N4	GV2 L07	2.5	> 100	LC1 D09●●
0.55	3/4	ATV 32H055N4	GV2 L08	4	> 100	LC1 D09●●
0.75	1	ATV 32H075N4	GV2 L08	4	> 100	LC1 D09●●
1.1	1 1/2	ATV 32HU11N4	GV2 L10	6.3	> 100	LC1 D09●●
1.5	2	ATV 32HU15N4	GV2 L14	10	> 100	LC1 D09●●
2.2	3	ATV 32HU22N4	GV2 L14	10	> 100	LC1 D09●●
3	–	ATV 32HU30N4	GV2 L16	14	50	LC1 D09●●
4	5	ATV 32HU40N4	GV2 L16	14	50	LC1 D09●●
5.5	7 1/2	ATV 32HU55N4	GV2 L22	25	50	LC1 D09●●
7.5	10	ATV 32HU75N4	GV2 L32	32	50	LC1 D18●●
11	15	ATV 32HD11N4	GV3 L40	40	50	LC1 D25●●
15	20	ATV 32HD15N4	GV3 L50	50	50	LC1 D32●●

(1) GV2 L, GV3 L: TeSys magnetic motor circuit-breakers; accessories (see page 35).

(2) Composition of TeSys contactors LC1 D09/D18/D25/D32 : 3 poles + 1 N/O auxiliary contact + 1 N/C auxiliary contact.

(3) The HP values given are NEC-compliant (National Electrical Code).

(4) Replace ●● with the control circuit voltage reference given in the table below:

<b>AC control circuit</b>						
	Volts ~	24	48	115	230	230/240
LC1-D	50/60 Hz	B7	E7	FE7	P7	U7

For other voltages between 24 V and 660 V, or a DC control circuit, please refer to the "Motor starter solutions - Control and protection components" catalogue or visit [www.schneider-electric.com](http://www.schneider-electric.com).

Accessories for TeSys circuit-breakers (1)

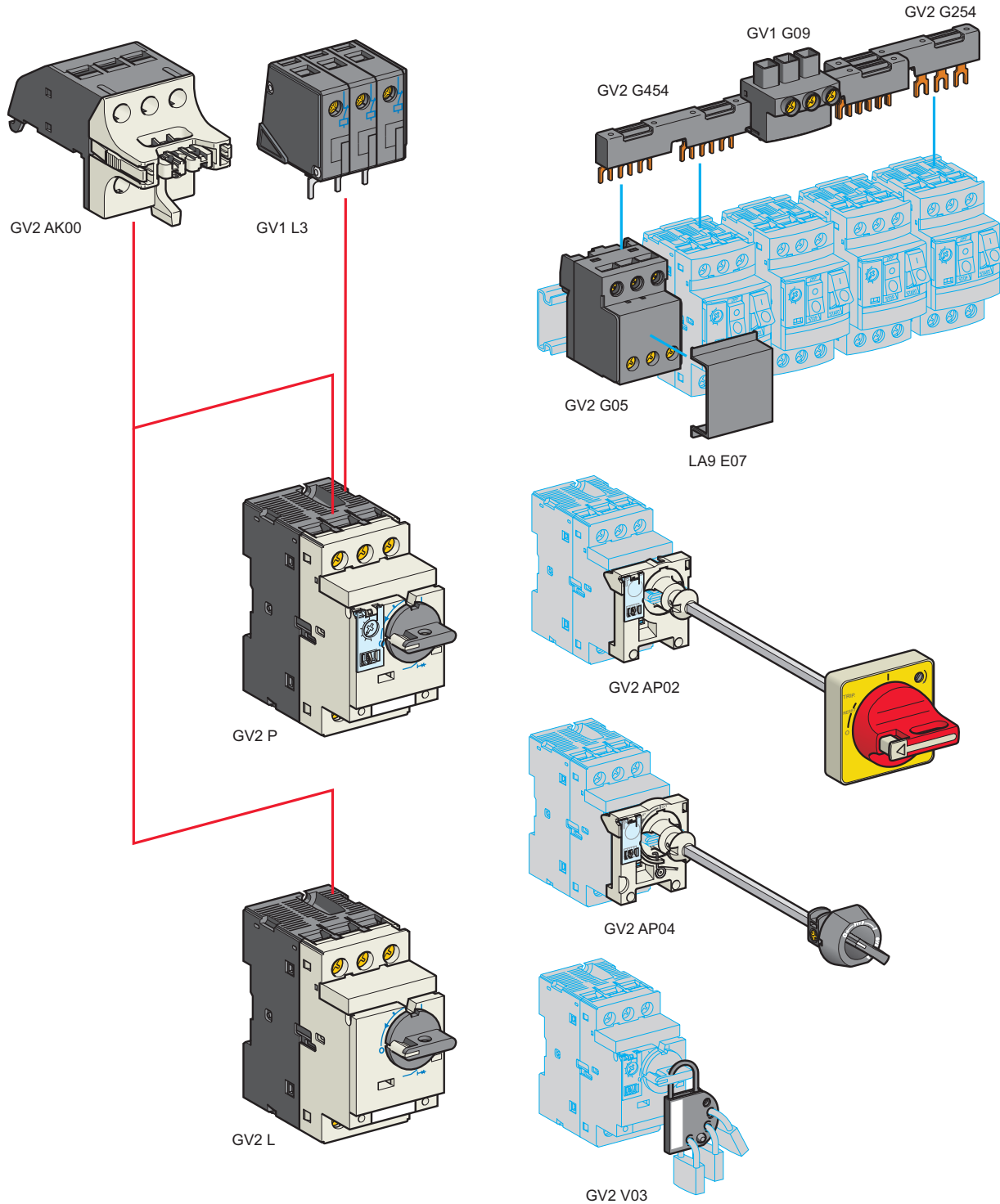

(1) Example of accessories available; complete list of references (see page 35).

# Variable speed drives

## Altivar 32

### Accessories for TeSys circuit-breakers



Example of GV2/ATV 32 direct mounting in an enclosure:  
GV2 L circuit-breakers + GV2 454 and GV2 G05 accessories  
+  
ATV 32HU15N4 drives

Accessories for TeSys circuit-breakers (continued) (1)			
Description	For circuit-breaker	Unit reference	Weight kg
<b>Add-on blocks</b>			
<b>Disconnecter (2)</b> Max. number: 1	Mounted on front	GV2 L07...L22, GV2 P07...P22	<b>GV2 AK00</b> 0.150
<b>Limiters</b> Max. number: 1	Mounted on the top	GV2 P	<b>GV1 L3</b> 0.130
	Separate	GV2 L/GV2 P	<b>LA9 LB920</b> 0.320
<b>Busbars</b>			
<b>3-pole busbars</b> 63 A, 2 tap links	45 mm interval	GV2 L/GV2 P	<b>GV2 G245</b> 0.036
	54 mm interval	GV2 L/GV2 P	<b>GV2 G254</b> 0.038
	72 mm interval	GV2 L/GV2 P	<b>GV2 G272</b> 0.042
<b>3-pole busbars</b> 63 A, 3 tap links	45 mm interval	GV2 L/GV2 P	<b>GV2 G345</b> 0.058
	54 mm interval	GV2 L/GV2 P	<b>GV2 G354</b> 0.060
<b>3-pole busbars</b> 63 A, 4 tap links	45 mm interval	GV2 L/GV2 P	<b>GV2 G445</b> 0.077
	54 mm interval	GV2 L/GV2 P	<b>GV2 G454</b> 0.085
	72 mm interval	GV2 L/GV2 P	<b>GV2 G472</b> 0.094
<b>3-pole busbars</b> 63 A, 5 tap links	54 mm interval	GV2 L/GV2 P	<b>GV2 G554</b> 0.100
<b>Terminals</b> For supplying one or more busbars GV2 G●●●	Connection at the top	GV2 L/GV2 P	<b>GV1 G09</b> 0.040
	Can take the limiter option GV1 L3	GV2 P	<b>GV2 G05</b> 0.115
<b>Protective end cover</b> For busbar output awaiting extension (order in multiples of 5)		GV2 L/GV2 P	<b>GV1 G10</b> 0.005
<b>Cover for terminals</b> For mounting in modular distribution boards (order in multiples of 10)		GV2 L/GV2 P	<b>LA9 E07</b> 0.005
<b>Adaptor</b>			
<b>"Large Spacing" adaptor</b> UL 508 type E		GV2 P07...P022	<b>GV2 GH7</b> 0.040
<b>External controls</b>			
<b>External control</b> Max. enclosure depth 290 mm Off visual indication. Red handle, yellow front plate, IP 54 Can be locked with padlock (not supplied)		GV2 L, GV2 P	<b>GV2 AP02</b> 0.200
<b>External control</b> Max. enclosure depth 290 mm No On and Off visual indication. Does not lock the door or plug-in base opening control mechanism in the On position Colour: RAL 7016, IP 54		GV2 L, GV2 P	<b>GV2 AP04</b> 0.104
<b>External control</b> Max. enclosure depth 390 mm Includes: A handle LU9 AP1●, a rod 260 mm long maximum, a bracket and an adaptor. Off visual indication. Red handle, yellow front plate, IP 54 Can be locked with padlock (not supplied)		GV3 L, GV3 P	<b>GV3 AP02</b> 0.294
<b>Padlocking device</b>			
<b>Padlocking device</b> Can take 4 padlocks (not supplied) ∅ 6 mm max.		GV2 L, GV2 P GV3 L, GV3 P	<b>GV2 V03</b> 0.092

(1) For a detailed description and other accessories for circuit-breakers, please refer to the "Motor starter solutions - Control and protection components" catalogue or visit [www.schneider-electric.com](http://www.schneider-electric.com).

(2) 3 poles isolated upstream of GV2 L and GV2 P circuit-breakers.





**Schneider Electric Industries SAS**

[www.schneider-electric.com](http://www.schneider-electric.com)

Head Office  
35, rue Joseph Monier  
F-92500 Rueil-Malmaison  
France

The information provided in this documentation contains general descriptions and/or technical characteristics of the performance of the products contained herein. This documentation is not intended as a substitute for and is not to be used for determining suitability or reliability of these products for specific user applications. It is the duty of any such user or integrator to perform the appropriate and complete risk analysis, evaluation and testing of the products with respect to the relevant specific application or use thereof. Neither Schneider Electric nor any of its affiliates or subsidiaries shall be responsible or liable for misuse of the information contained herein.

Design: Schneider Electric  
Photos: Schneider Electric  
Printed by: