

1703104-1 ✓ ACTIVE

RAST | RAST 5 IDC Connectors, RAST 5D

TE Internal #: 1703104-1

Housing, Receptacle, Wire-to-Board, 5 Position, 5 mm [.197 in]
Centerline, Crimp, 1 Row, Natural, Mating Retention, RAST 5 IDC
Connectors

[View on TE.com >](#)



Connectors > PCB Connectors > Wire-to-Board Connectors > Wire-to-Board Connector Assemblies & Housings

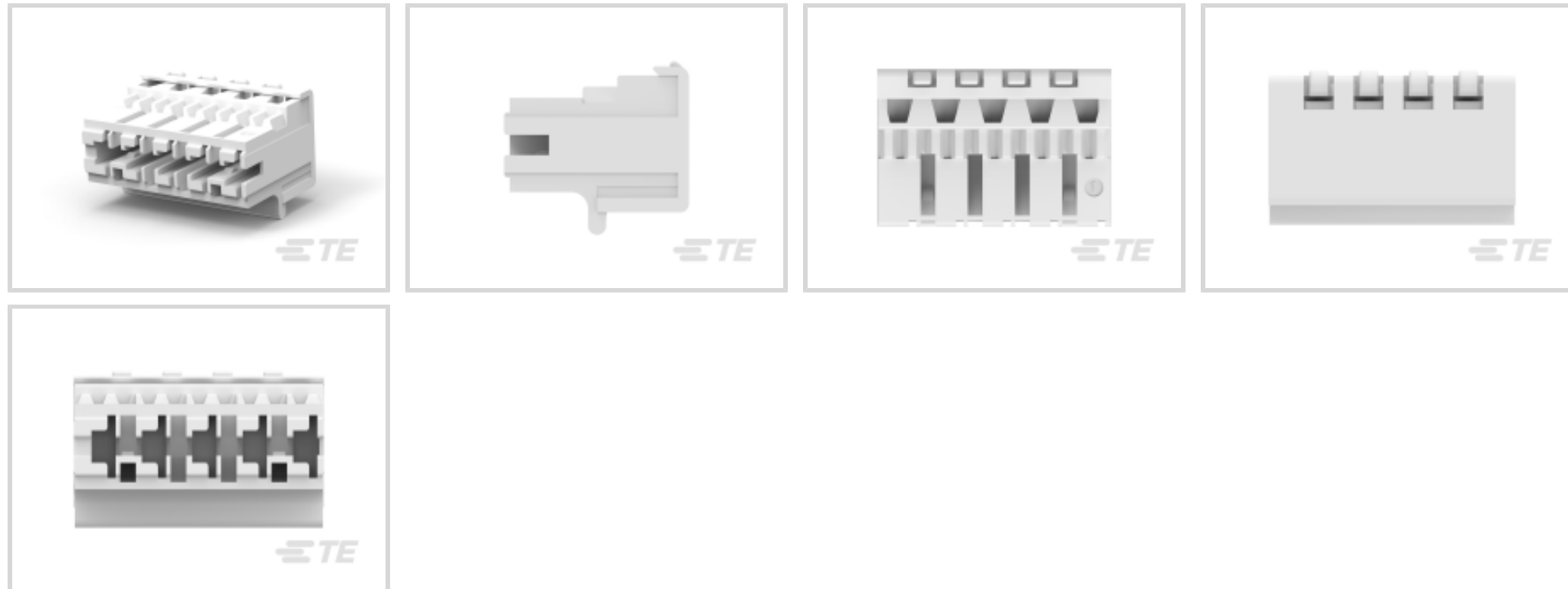

Connector Product Type: **Housing**

Connector & Housing Type: **Receptacle**

Connector System: **Wire-to-Board**

Number of Positions: **5**

Centerline (Pitch): **5 mm [.197 in]**

Features

Product Type Features

Connector Product Type	Housing
Connector & Housing Type	Receptacle
Connector System	Wire-to-Board
Sealable	No
Connector & Contact Terminates To	Wire & Cable

Configuration Features

Number of Positions	5
Number of Rows	1

Body Features

Primary Product Color	Natural
-----------------------	---------

Termination Features

Termination Method to Wire & Cable	Crimp
------------------------------------	-------

Mechanical Attachment

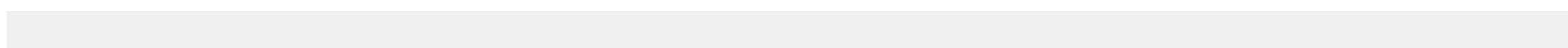



Mating Retention Type	Lock
Mating Retention	With
Connector Mounting Type	Cable Mount (Free-Hanging)

Housing Features

Housing Material	PA 6.6
Centerline (Pitch)	5 mm [.197 in]

Usage Conditions

Operating Temperature Range	-40 – 105 °C [-40 – 221 °F]
-----------------------------	-----------------------------

Operation/Application

Circuit Application	Power & Signal
---------------------	----------------

Product Compliance

[For compliance documentation, visit the product page on TE.com>](#)

EU RoHS Directive 2011/65/EU	Compliant
EU ELV Directive 2000/53/EC	Compliant
China RoHS 2 Directive MIIT Order No 32, 2016	No Restricted Materials Above Threshold
EU REACH Regulation (EC) No. 1907/2006	Current ECHA Candidate List: JUNE 2024 (241) Candidate List Declared Against: JUNE 2024 (241) Does not contain REACH SVHC
Halogen Content	Low Halogen - Br, Cl, F, I < 900 ppm per homogenous material. Also BFR/CFR/PVC Free
Solder Process Capability	Not applicable for solder process capability

Product Compliance Disclaimer

This information is provided based on reasonable inquiry of our suppliers and represents our current actual knowledge based on the information they provided. This information is subject to change. The part numbers that TE has identified as EU RoHS compliant have a maximum concentration of 0.1% by weight in homogenous materials for lead, hexavalent chromium, mercury, PBB, PBDE, DBP, BBP, DEHP, DIBP, and 0.01% for cadmium, or qualify for an exemption to these limits as defined in the Annexes of Directive 2011/65/EU (RoHS2). Finished electrical and electronic equipment products will be CE marked as required by Directive 2011/65/EU. Components may not be CE marked. Additionally, the part numbers that TE has identified as EU ELV compliant have a maximum concentration of 0.1% by weight in homogenous materials for lead, hexavalent chromium, and mercury, and 0.01% for cadmium, or qualify for an exemption to these limits as defined in the Annexes of Directive 2000/53/EC (ELV). Regarding the REACH Regulation, the information TE provides on SVHC in articles for this part number is based on the latest European Chemicals Agency (ECHA) 'Guidance on requirements for substances in articles' posted at this URL: <https://echa.europa.eu/guidance-documents/guidance-on-reach>

Compatible Parts



Also in the Series | RAST 5 IDC Connectors

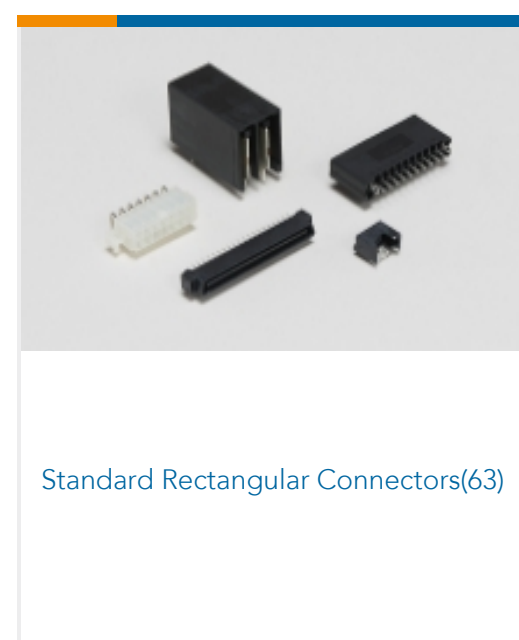
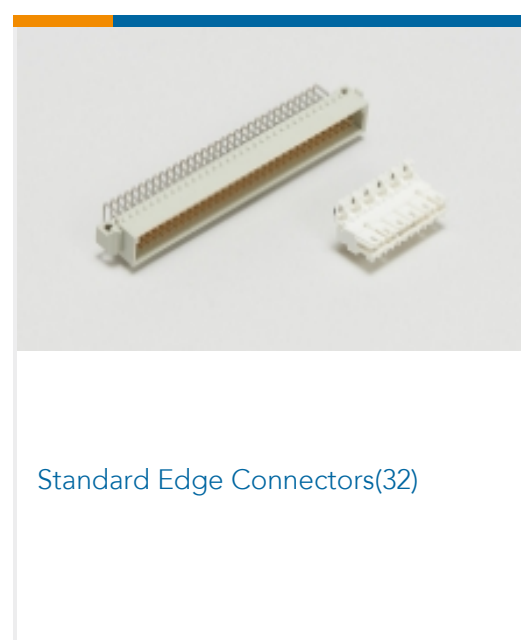
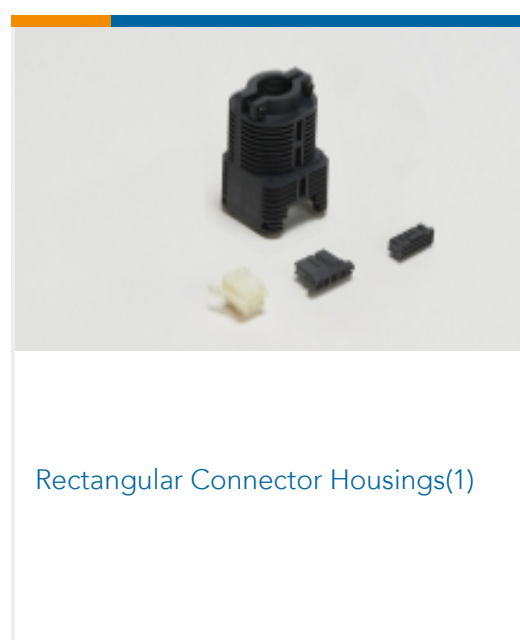
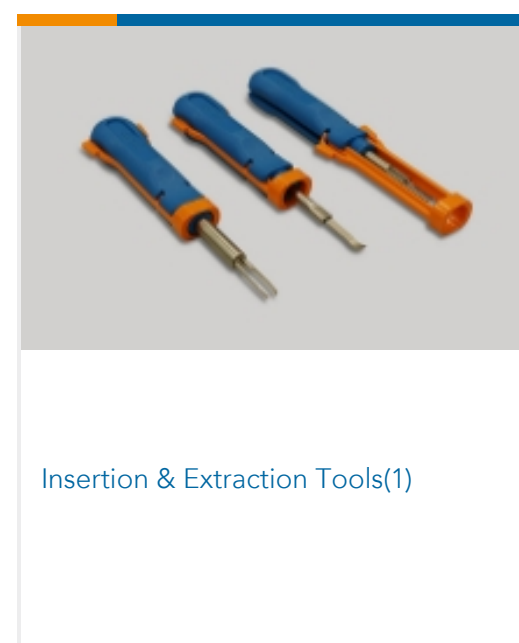
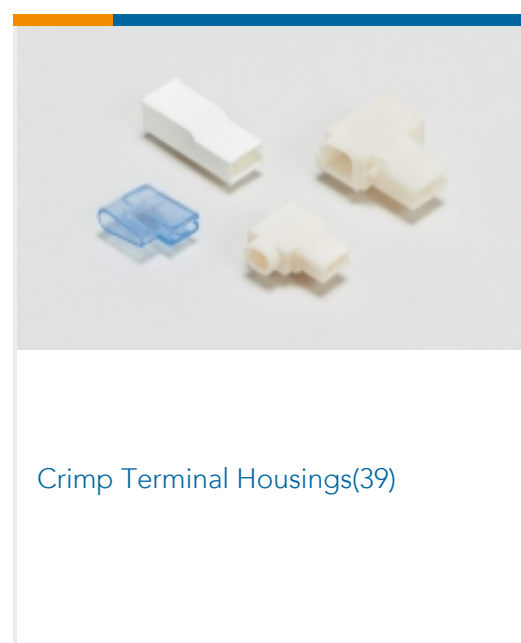
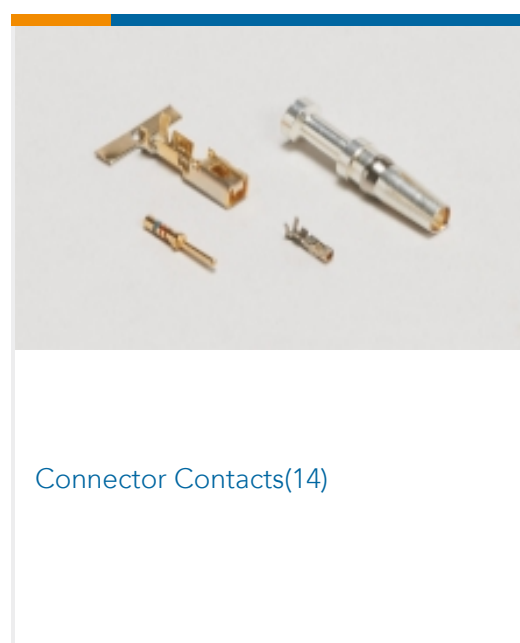
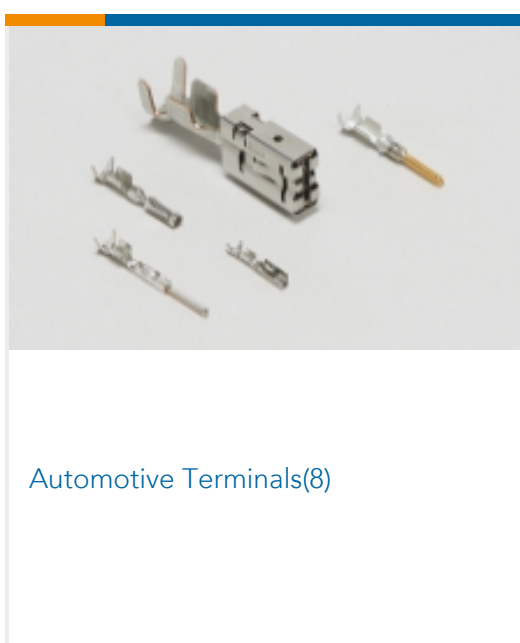



Wire-to-Board Connector Assemblies & Housings(202)

Also in the Series | RAST 5D



Automotive Terminals(5)



Connector Contacts(10)



Insertion & Extraction Tools(1)

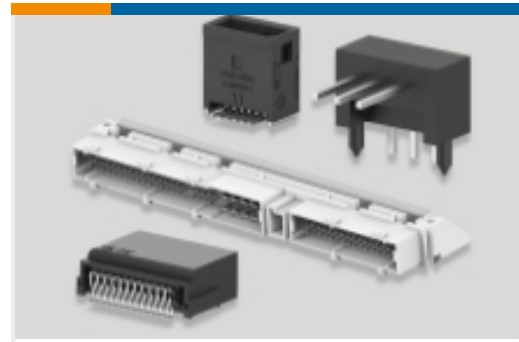

PCB Headers & Receptacles(69)



Wire-to-Board Connector Assemblies & Housings(78)

Customers Also Bought

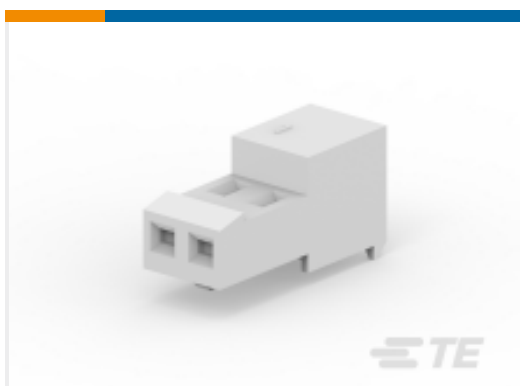

TE Part #4-640441-0
MTA Receptacle: Nylon, Tin Plated,
2.54 mm



TE Part #59804-1
MAINTENANCE TOOL



TE Part #350551-6
UMNL SOK 20-14 AU/PHBZ L/P

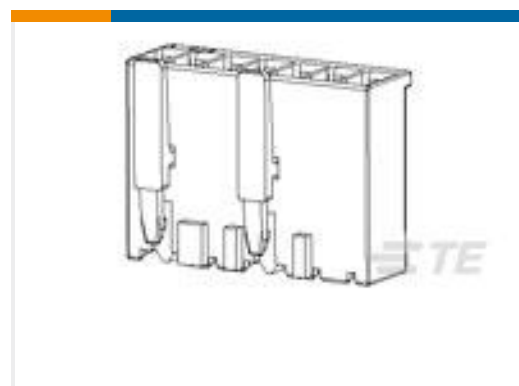

TE Part #2-928247-5
STD TIMER GEH 5P

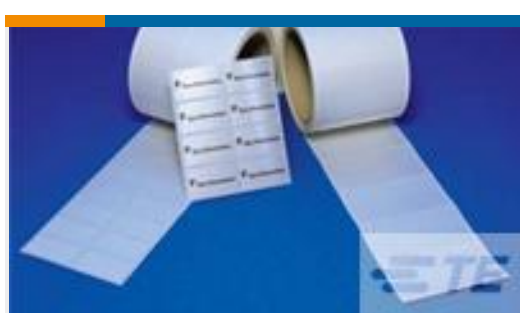

TE Part #2-1768019-4
EET-52105P-8A



TE Part #926770-1
MT.EDGE CRIMP CONT.



Documents

Product Drawings

5 POS MT - EDGE HOUSING

English

CAD Files

3D PDF

3D

Customer View Model

[ENG_CVM_CVM_1703104-1_C_c-1703104-1-c.2d_dxf.zip](#)

English

Customer View Model

[ENG_CVM_CVM_1703104-1_C_c-1703104-1-c.3d_igs.zip](#)

English

Customer View Model

[ENG_CVM_CVM_1703104-1_C_c-1703104-1-c.3d_stp.zip](#)

English

By downloading the CAD file I accept and agree to the [Terms and Conditions](#) of use.

Datasheets & Catalog Pages

RAST Connector System Catalog

English