

## SCH16T-K01 Data Sheet

### 6-DOF XYZ-Axis gyroscope and XYZ-Axis accelerometer with digital SPI interface

#### Features

- Gyroscope measurement range selectable in-application from 300 °/s down to 62.5 °/s
- Accelerometer measurement range selectable in-application from  $\pm 80$  m/s<sup>2</sup> down to  $\pm 15$  m/s<sup>2</sup> with typical default dynamic range up to  $\pm 260$  m/s<sup>2</sup>
- Options for output interpolation and decimation
- Angular rate and acceleration low pass filters from 13Hz to 370 Hz cut-off rate
- Data Ready output, timestamp index and SYNC input functions for clock domain synchronization
- -40...110 °C operating temperature range
- 3.0...3.6 V supply voltage, 1.7...3.6 V I/O supply voltage
- SafeSPI v2.0 interface
- 20-bit and 16-bit output data, selectable via SPI frame
- Extensive self-diagnostic features utilizing over 200 monitoring signals
- 11.8 mm x 13.4 mm x 2.9 mm (l x w x h) SOIC-24
- Qualification based on AEC-Q100 standard

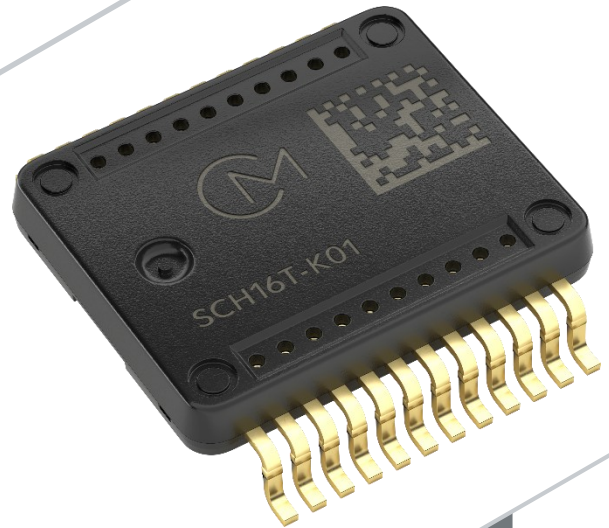

#### Applications

SCH16T-K01 is targeted at applications demanding high performance with tough environmental requirements. Typical applications include:

- Inertial measurement units (IMUs)
- Inertial navigation and positioning
- Machine control and guidance
- Dynamic inclination
- Robotic control and UAVs

#### Application restriction

- <https://www.murata.com/en-global/support/militaryrestriction>

#### Overview

The SCH16T-K01 is a combined high-performance 3-axis angular rate and 3-axis accelerometer. The angular rate and accelerometer sensor elements are based on Murata's proven capacitive 3D-MEMS technology. Signal processing is done by a single mixed-signal ASIC that provides angular rate and acceleration via a flexible SafeSPI v2.0 compliant digital interface. Sensor elements and ASIC are packaged to pre-molded SOIC 24-pin plastic housing that guarantees reliable operation over the product's lifetime.

The SCH16T-K01 is designed, manufactured, and tested for high stability, reliability, and quality requirements. The component has extremely stable output over temperature, humidity, and vibration. The component has several advanced self-diagnostic features, is suitable for SMD mounting and is compatible with RoHS and ELV directives.

## TABLE OF CONTENTS

<b>1</b>	<b>Introduction</b> .....	<b>4</b>
<b>2</b>	<b>Product types and order codes with packing quantity</b> .....	<b>4</b>
<b>3</b>	<b>Specifications</b> .....	<b>4</b>
3.1	Abbreviations .....	4
3.2	General specifications.....	5
3.3	Absolute maximum ratings.....	5
3.4	Performance specifications for gyroscope.....	6
3.5	Performance specifications for accelerometer .....	8
3.6	Gyroscope typical performance characteristics .....	10
3.7	Accelerometer typical performance characteristics .....	11
3.8	Gyroscope and accelerometer frequency response and filter characteristics .....	13
3.9	Pin description .....	14
3.10	Digital I/O specification .....	16
3.11	SPI AC characteristics .....	16
3.12	Measurement axis and directions.....	18
3.13	Package outline and dimensions .....	19
3.14	PCB footprint .....	20
<b>4</b>	<b>General product description</b> .....	<b>21</b>
4.1	Component block diagram .....	21
4.2	Accelerometer.....	22
4.3	Gyroscope .....	22
4.4	Factory calibration .....	22
<b>5</b>	<b>Component operation, reset and power-up</b> .....	<b>22</b>
5.1	Component operation .....	22
5.2	Start-up sequence .....	22
5.3	Component output channels .....	24
5.4	Solutions for asynchronous clock domains .....	25
5.4.1	Interpolation .....	25
5.4.2	Decimation.....	26
5.4.3	SYNC input pin .....	26
5.4.4	Data ready, DRY.....	28
5.4.5	Data counter .....	29
5.4.6	Frequency counter.....	29
5.4.7	Calculating exact time stamp .....	29
5.5	Recommended reading procedure for sensor data .....	30
<b>6</b>	<b>Component interfacing</b> .....	<b>31</b>
6.1	Safe SPI .....	31
6.2	SPI frame structure .....	32
6.3	Multi-slave operation.....	33
6.4	SPI frame status bits.....	34
6.5	Cyclic redundancy check (CRC) .....	36
6.5.1	SPI48BF CRC .....	36
6.5.2	SPI32BF CRC .....	37
6.6	Operations .....	38
6.6.1	32-bit mode operations .....	38
6.6.2	48-bit mode operations .....	40
<b>7</b>	<b>Register definition</b> .....	<b>42</b>
7.1	Register map user guide.....	42
7.1.1	Value and address formats .....	42

7.1.2	Register map overview .....	42
7.2	Sensor data block .....	43
7.2.1	Example of angular rate data conversion .....	44
7.2.2	Example of acceleration data conversion .....	44
7.2.3	Example of temperature data conversion .....	45
7.3	Sensor status block .....	45
7.3.1	Data counters .....	46
7.3.2	Frequency counter / timestamp .....	46
7.3.3	Status summary .....	46
7.3.4	Saturation status summary .....	47
7.3.5	Common status .....	47
7.3.6	Gyroscope common status .....	48
7.3.7	Gyroscope status XYZ .....	48
7.3.8	Accelerometer status XYZ .....	49
7.3.9	Additional status registers .....	50
7.4	Sensor control block .....	51
7.4.1	Filter settings .....	51
7.4.2	Dynamic range and decimation .....	52
7.4.3	User interface control .....	54
7.4.4	Self-test controls .....	55
7.4.5	Sensor mode control and soft reset .....	55
7.4.6	Whoami, traceability, identification, and spare registers .....	56
<b>8</b>	<b>Application information .....</b>	<b>58</b>
8.1	Application circuitry and external component characteristics .....	58
8.2	General application PCB layout .....	58
<b>9</b>	<b>Assembly instructions .....</b>	<b>59</b>

## 1 Introduction

This document contains essential technical information about the SCH16T-K01 sensor including specifications, SPI interface descriptions, user-accessible register details, electrical properties, and application information. This document should be used as a reference when designing in the SCH16T-K01 component.

## 2 Product types and order codes with packing quantity

Table 1 Product types and order codes

Product Type	Description	Packing	Quantity
SCH16T-K01-004	Gyroscope $\pm 300$ °/s, Accelerometer $\pm 80$ m/s <sup>2</sup>	Sample package, Bulk	4 pcs
SCH16T-K01-1		Tape & Reel	100 pcs
SCH16T-K01-10		Tape & Reel	1000 pcs

## 3 Specifications

### 3.1 Abbreviations

ACC	Accelerometer
ARS	Angular Rate Sensor (gyroscope)
ASIC	Application Specific Integrated Circuit
AEC-Q100	Automotive Electronics Council Failure Mechanism Based Stress Test Qualification For Integrated Circuits
CS	Chip Select
DOF	Degrees of Freedom
DPS	Degrees Per Second
DRY	Data Ready
F_PRIM	Gyroscope Primary Frequency
FIFO	First In First Out
FREQ	Frequency
Gyro	Gyroscope
LPM	Low Power Mode
LPF	Low-Pass Filter
MCLK	Master clock
MCU	Microcontroller Unit
MEMS	Micro-Electro-Mechanical System
MISO	Master In Slave Out
MOSI	Master Out Slave In
ODR	Output Data Rate
PD	Pull Down
PU	Pull Up
RT	Room Temperature
SCK	Serial Clock
SPI	Serial Peripheral Interface
SYNC	Synchronization

### 3.2 General specifications

Table 2 General specifications

Parameter	Min	Nom	Max	Unit
Operating Temperature <sup>(1)</sup>	-40		110	°C
Supply Voltage	3.0	3.3	3.6	V
Digital I/O supply <sup>(2)</sup>	1.7		3.6	V
Total Supply Current	36	41	47	mA
Low Power Mode current consumption			10	mA
Gyro Primary Frequency, F_PRIM	22.1	23.6	25.1	kHz
Output update rate (ODR) - Interpolated outputs (F_PRIM x 16)	353.6	377.6	401.6	kHz
Output update rate (ODR) - Decimated outputs		23.6/X <sup>(3)</sup>		kHz
Turn-on-time <sup>(4)</sup>			250	ms
Weight		0.612		gram

1) Specifications are valid within the temperature range

2) Can exceed supply voltage

3) Decimation ratio X is selectable from the following options: 2, 4, 8, 16 and 32

4) After voltage supplies are within specification

### 3.3 Absolute maximum ratings

Murata guarantees sensor operation without parameter related damage or functional deviation within these maximum ratings. However, output values are specified only for conditions specified in the chapters *Performance specifications for gyroscope* and *Performance specifications for accelerometer*. All voltages are related to the potential at GND.

Table 3 Absolute maximum ratings

Parameter	Remark	Min	Nom	Max	Unit
Supply voltage	Supply voltage (pins V3P3, VDDIO)	-0.3		3.63	V
Storage Temperature	No damage to the component will occur up to max 24 hours within these maximum ratings	-50		150	°C
ESD_HBM	ESD according to Human Body Model (HBM), Q100-002	2000			V
ESD_CDM center pins	Center pins ESD according to Charged Device Model (CDM), Q100-011	500			V
ESD_CDM corner pins	corner pins ESD according to Charged Device Model (CDM), Q100-011	750			V
Ultrasonic agitation	Cleaning, welding, etc.		Prohibited		

### 3.4 Performance specifications for gyroscope

Table 4 Performance specifications for all measurement axes, supply voltage = 3.3 V and at room temperature unless otherwise specified

Parameter	Condition	Min (-3 $\sigma$ )	Typical	Max (+3 $\sigma$ )	Unit
Measurement range <sup>A)</sup>	Guaranteed valid specification range, lowest selectable sensitivity setting	$\pm 300$			$^{\circ}/s$
	Guaranteed valid specification range, highest selectable sensitivity setting	$\pm 62.5$			$^{\circ}/s$
Offset <sup>B)</sup>	-40 $^{\circ}C$ ... +110 $^{\circ}C$	-0.6		0.6	$^{\circ}/s$
Offset drift over temperature <sup>C)</sup>	-40 $^{\circ}C$ ... +110 $^{\circ}C$	-0.2		0.2	$^{\circ}/s$
Offset drift over lifetime <sup>D)</sup>	After HTOL 1000h	-0.2		0.2	$^{\circ}/s$
Default sensitivity – 16-bit mode <sup>E)</sup>	Nominal value		100		LSB/( $^{\circ}/s$ )
Default sensitivity – 20-bit mode <sup>E)</sup>	Nominal value		1600		LSB/( $^{\circ}/s$ )
Sensitivity drift over temperature <sup>F)</sup>	XY axis, -40 $^{\circ}C$ ... +110 $^{\circ}C$	-0.3		0.3	%
	Z axis, -40 $^{\circ}C$ ... +110 $^{\circ}C$	-0.2		0.2	%
Sensitivity drift over lifetime <sup>G)</sup>	After HTOL 1000h	-0.3		0.3	%
Linearity error $\pm 300$ $^{\circ}/s$ <sup>H)</sup>	-40 $^{\circ}C$ ... +110 $^{\circ}C$		0.02	0.08	$^{\circ}/s$
Noise density	XY axis		0.0004		( $^{\circ}/s$ )/ $\sqrt{Hz}$
	Z axis		0.0006		( $^{\circ}/s$ )/ $\sqrt{Hz}$
Angle random walk <sup>I)</sup>	XY axis		0.015		$^{\circ}/\sqrt{h}$
	Z axis		0.025		$^{\circ}/\sqrt{h}$
Bias instability <sup>J)</sup>	Allan variance minimum divided by 0.664		0.5		$^{\circ}/h$
Orthogonality error (between rate axes) <sup>K)</sup>	-40 $^{\circ}C$ ... +110 $^{\circ}C$	-0.15		0.15	%
G-sensitivity <sup>L)</sup>	For DC gravity input		0.0003	0.006	( $^{\circ}/s$ )/(m/s <sup>2</sup> )

Notes:

- Specified Min/Max values contain  $\pm 3$  sigma variation limits of original test population. Typical values are validation population mean (unless otherwise specified). Min/Max and typical values are not guaranteed, values represent validation population characteristics.
- Specification is valid after 24 hours from reflow.
- Each system design including SCH16T series component must be evaluated by the customer in advance to guarantee proper functionality during operation.

Table 5 Gyroscope parameter definitions

Symbol	Description
A)	Measurement range is tied to electrical headroom and is selectable from predefined options presented in 7.4.2. Changing electrical headroom affects only signal path sensitivity (up to 4*nominal sensitivity).
B)	Initial offset at Murata production measurement after calibration
C)	Offset drift over temperature is determined by ((maximum offset value over temperature) - (minimum offset value over temperature)) / 2 in condition of one temperature sweep in specified temperature range.
D)	Estimated from offset drift during 1000 hours of high temperature operating life (HTOL) test at 125 °C and maximum supply voltages.
E)	Default sensitivity used in factory calibration. With this default sensitivity, signal has a typical electrical headroom of ±327.5 °/s.
F)	$Sensitivity = \frac{AR_{meas}(\Omega_{max}) - AR_{meas}(\Omega_{min})}{\Omega_{max} - \Omega_{min}}$ Where: $\Omega_{max}$ = applied angular rate at maximum operating range $\Omega_{min}$ = applied angular rate at minimum operating range $AR_{meas}(\Omega_n)$ = measured angular rate at $\Omega_n$ [LSB] Sensitivity drift over temperature is determined by [(maximum sensitivity value over temperature) - (minimum sensitivity value over temperature)] / 2 *100 %
G)	Estimated from sensitivity drift during 1000 hours of high temperature operating life (HTOL) test at 125 °C and maximum supply voltages.
H)	Linearity error is the residual error remaining after a least-squares linear fit over measurement range. (Best fit linear model)
I)	Angle random walk is the white noise term estimated from Allan deviation at tau = 1 s
J)	Allan variance minimum divided by 0.664. Measured with 13 Hz low pass filter setting, 200 Hz sample rate and fifteen-minute stabilization time before data collection starts to permit full thermal stabilization.
K)	Rate axes are orthogonal if their intersecting angle is exactly 90 °. Orthogonality error is the deviation from 90 °.
L)	Angular rate offset sensitivity in respect to orientation in the earth gravitation. Maximum value contains 0.004 °/s from Earth's rotation. Typical value is only measured from orientations that are not affected by the earth's rotation and therefore, is not verified in all orientations. Can not be extrapolated beyond gravitation.

### 3.5 Performance specifications for accelerometer

Table 6 Performance specifications for all measurement axes, up to  $\pm 80$  m/s<sup>2</sup> measurement range, supply voltage = 3.3 V and at room temperature unless otherwise specified

Parameter	Condition	Min (-3 $\sigma$ )	Typical	Max (+3 $\sigma$ )	Unit
Measurement range <sup>A)</sup>	Guaranteed valid specification range, lowest selectable sensitivity setting	$\pm 80$			m/s <sup>2</sup>
	Guaranteed valid specification range, highest selectable sensitivity setting	$\pm 15$			m/s <sup>2</sup>
Offset <sup>B)</sup>	-40 °C ... +110 °C	-0.14		0.14	m/s <sup>2</sup>
Offset drift over temperature <sup>C)</sup>	-40 °C ... +110 °C	-0.07		0.07	m/s <sup>2</sup>
Offset drift over lifetime <sup>D)</sup>	After HTOL 1000h	-0.05		0.05	m/s <sup>2</sup>
Default sensitivity – 16-bit mode <sup>E)</sup>	Nominal value		200		LSB/(m/s <sup>2</sup> )
Default sensitivity – 20-bit mode <sup>E)</sup>	Nominal value		3200		LSB/(m/s <sup>2</sup> )
Sensitivity drift over temperature <sup>F)</sup>	-40 °C ... +110 °C	-0.15		0.15	%
Sensitivity drift over lifetime <sup>G)</sup>	After HTOL 1000h	-0.1		0.1	%
Linearity error <sup>H)</sup>	Full Scale -40 °C ... +110 °C		0.06	0.15	m/s <sup>2</sup>
	-1 g...1 g, -40 °C ... +110 °C			0.01	m/s <sup>2</sup>
Noise density			0.8		(mm/s <sup>2</sup> )/ $\sqrt{Hz}$
Velocity random walk <sup>I)</sup>			30		(mm/s)/ $\sqrt{h}$
Bias instability <sup>J)</sup>	Allan variance minimum divided by 0.664		0.2		mm/s <sup>2</sup>
Orthogonality error (between ACC axes) <sup>K)</sup>	-40 °C ... +110 °C	-0.15		0.15	%

Notes:

- Specified Min/Max values contain  $\pm 3$  sigma variation limits of original test population. Typical values are validation population mean (unless otherwise specified). Min/Max and typical values are not guaranteed, values represent validation population characteristics.
- Specification is valid after 24 hours from reflow.
- Each system design including SCH16T series component must be evaluated by the customer in advance to guarantee proper functionality during operation.
- A factor of 102 can be used when converting m/s<sup>2</sup> to milli-g. Actual gravity depends on sensor location on Earth.



Table 7 Accelerometer parameter definitions

Symbol	Description
A)	Measurement range is tied to electrical headroom and is selectable from predefined options presented in 7.4.2. Changing electrical headroom affects only signal path sensitivity (up to 4*nominal sensitivity).
B)	Initial offset at Murata production measurement after calibration
C)	Offset drift over temperature is determined by ((maximum offset over temperature) - (minimum offset over temperature)) / 2 in condition of one temperature sweep in specified temperature range.
D)	Estimated from offset drift during 1000 hours of high temperature operating life (HTOL) test at 125 °C and maximum supply voltages.
E)	Default sensitivity used in factory calibration. With this default sensitivity, signal has a typical electrical headroom of ±163.4 m/s <sup>2</sup> .
F)	$Sensitivity = \frac{ACC_{meas}(a_{+1g}) - ACC_{meas}(a_{-1g})}{a_{+1g} - a_{-1g}}$ Where: a <sub>+1g</sub> = applied acceleration at +1g (i.e., +1g gravity of manufacturing location) a <sub>-1g</sub> = applied acceleration at -1g (i.e., -1g gravity of manufacturing location) ACC <sub>meas</sub> (a <sub>n</sub> ) = measured acceleration at a <sub>n</sub> [LSB] Sensitivity drift over temperature is determined by [(maximum sensitivity value over temperature) - (minimum sensitivity value over temperature)] / 2 * 100 %
G)	Estimated from sensitivity drift during 1000 hours of high temperature operating life (HTOL) test at 125 °C and maximum supply voltages.
H)	Linearity error is the residual error remaining after a least-squares linear fit over measurement range. (Best fit linear model)
I)	Velocity random walk is the white noise term estimated from Allan deviation at tau = 1 s
J)	Allan variance minimum divided by 0.664. Measured with 13 Hz low pass filter setting, 200 Hz sample rate and fifteen-minute stabilization time before data collection starts to permit full thermal stabilization.
K)	ACC axes are orthogonal if their intersecting angle is exactly 90 °. Orthogonality error is the deviation from 90 °.

### 3.6 Gyroscope typical performance characteristics

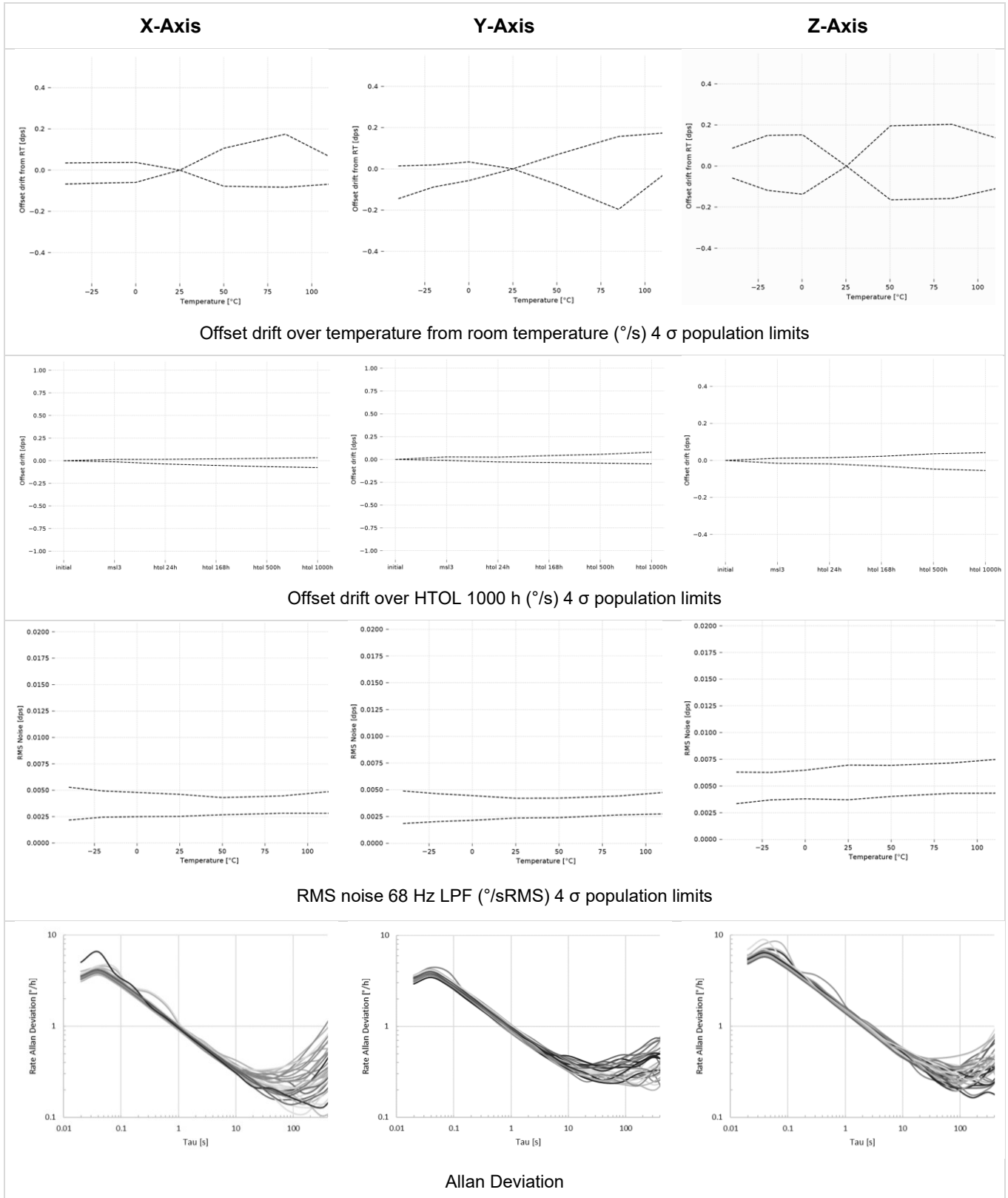

### 3.7 Accelerometer typical performance characteristics

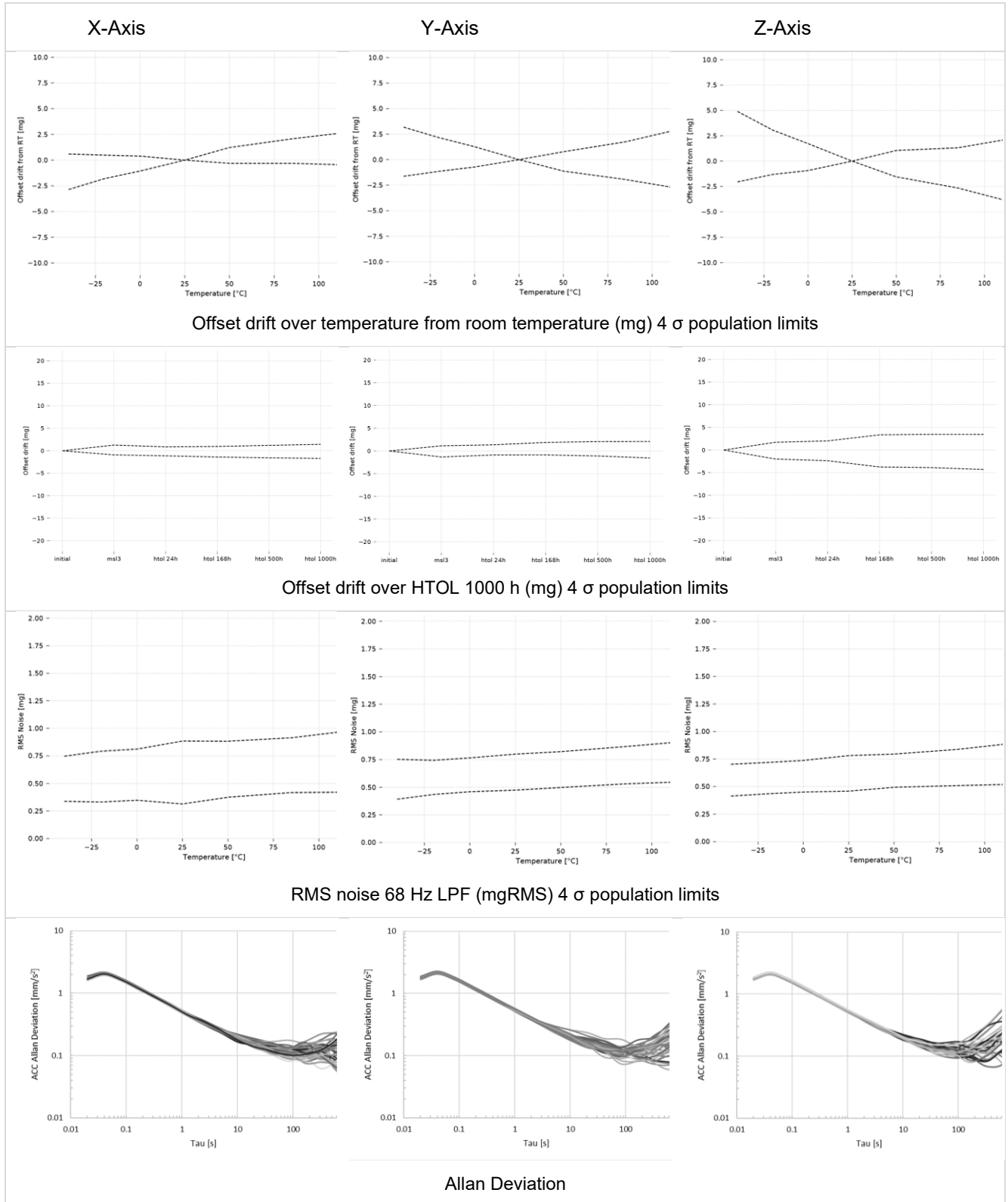

Temperature sensor

Table 8 Temperature sensor performance specification

Parameter	Min	Nom	Max	Unit
Measurement range	-50		135	°C
Temperature signal sensitivity		100		LSB/°C
Total Error	-15		15	°C
Linearity	-1		1	°C

Temperature is converted to °C with following equation:

Temperature [°C] = TEMP / 100, where TEMP is temperature sensor output register content in 2's complement format.

### 3.8 Gyroscope and accelerometer frequency response and filter characteristics

Table 9 SCH16T-K01 component low pass filter characteristics. Empty columns are not defined.

Filter	Axis	Title	Type	Order	Min	Nom	Max	Unit	
LPF0	Gyroscope	Cut-off frequency (-3 dB)	Butterworth	4	63.5	68	72.5	Hz	
		Group Delay					10	ms	
		Settling time					10	20	ms
	Accelerometer	Cut-off frequency (-3 dB)	Butterworth	4	63.5	68	72.5	Hz	
		Group Delay						10	ms
		Settling time							ms
LPF1	Gyroscope	Cut-off Frequency (-3 dB)	Butterworth	4	28	30	32	Hz	
		Group Delay					22	ms	
		Settling time					25	40	ms
	Accelerometer	Cut-off Frequency (-3 dB)	Butterworth	4	28	30	32	Hz	
		Group Delay						16	ms
		Settling time							ms
LPF2	Gyroscope	Cut-off Frequency (-3 dB)	Butterworth	3	12.2	13	13.8	Hz	
		Group Delay					35	ms	
		Settling time					65	200	ms
	Accelerometer	Cut-off Frequency (-3 dB)	Butterworth	3	12.2	13	13.8	Hz	
		Group Delay						35	ms
		Settling time							ms
LPF3	Gyroscope	Cut-off Frequency (-3 dB)	Bessel	4	262	280	300	Hz	
		Group Delay					2.5	ms	
		Settling time						5	ms
	Accelerometer	Cut-off Frequency (-3 dB)	Bessel	4	200	240	275	Hz	
		Group Delay						1.95	ms
		Settling time							ms
LPF4	Gyroscope	Cut-off Frequency (-3 dB)	Bessel	3	346	370	394	Hz	
		Group Delay					2	ms	
		Settling time							ms
	Accelerometer	Cut-off Frequency (-3 dB)	Bessel	3	234	290	380	Hz	
		Group Delay						1.56	ms
		Settling time							ms
LPF5	Gyroscope	Cut-off Frequency (-3 dB)	Bessel	3	220	235	250	Hz	
		Group Delay					2.5	ms	
		Settling time							ms
	Accelerometer	Cut-off Frequency (-3 dB)	Bessel	3	179	210	235	Hz	
		Group Delay						2.05	ms
		Settling time							ms
LPF7	Gyroscope	Cut-off Frequency (-3 dB)						Hz	
		Group Delay							ms
		Settling time						0.78	ms
	Accelerometer	Cut-off Frequency (-3 dB)							Hz
		Group Delay							ms
		Settling time						0.78	ms

### 3.9 Pin description

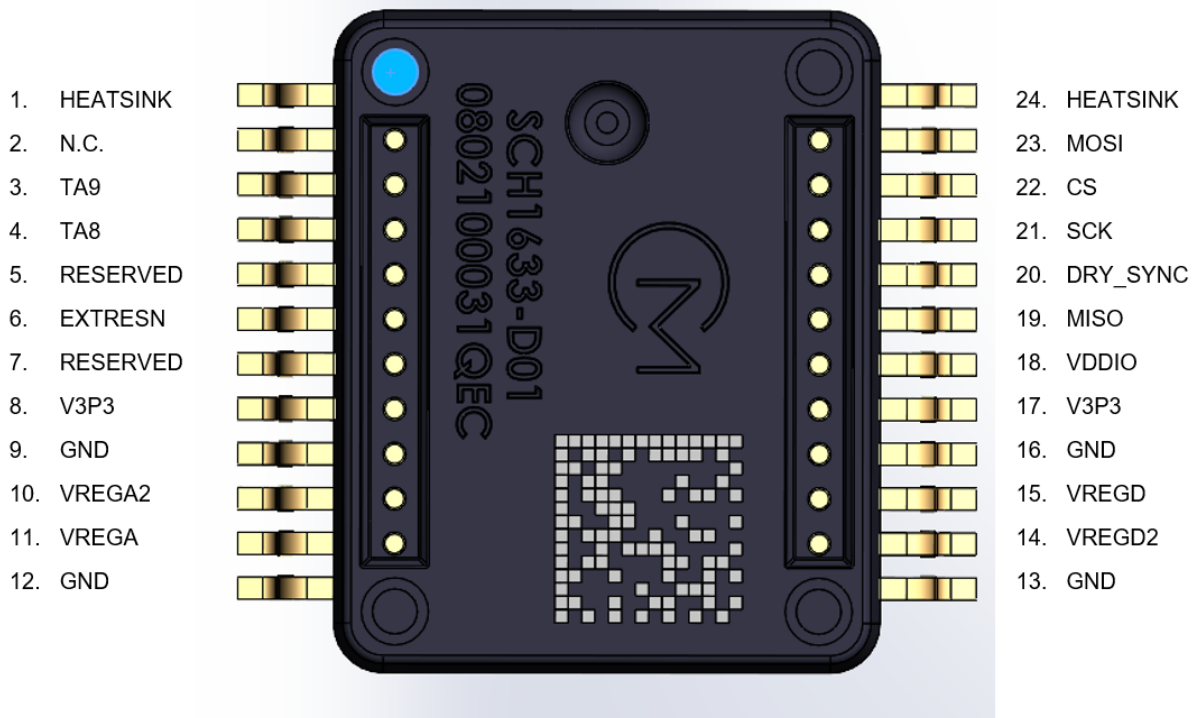

Figure 1 SCH16T-K01 pin layout

Table 10 SCH16T-K01 pin description

Pin #	Name	Description	Type	Voltage Level	Default state/structure
1	HEATSINK	Heatsink connection	GND	0 V	
2	Reserved	Leave floating	N/A		
3	TA9	SPI device selection Address 1 (static). Slave addressing in SafeSPI2. Max four slaves can be addresses by TA9:8. TA on the slave is defined by DVIO logic level at pins TA9 and TA8.	DIN	0 V	0/PDR <sup>1)</sup>
4	TA8	SPI device selection Address 0 (static). Slave addressing in SafeSPI2. Max four slaves can be addresses by TA9:8. TA on the slave is defined by DVIO logic level at pins TA9 and TA8.	DIN	0 V	0/PDR <sup>1)</sup>
5	Reserved	Connect to GND	N/A		
6	EXTRESN	External reset input (low active) during normal operation.	DIN/AIN	VDDIO	1/PUR <sup>1)</sup>
7	Reserved	Connect to GND	N/A		

Pin #	Name	Description	Type	Voltage Level	Default state/structure
8	V3P3	External unregulated inputs for the core supply regulators	SUPPLY	3.3 V	
9	GND	Ground	GND	0 V	
10	VREGA2	Regulated core voltage for the analog circuitry. External capacitor connection for positive reference/supply voltage. Connected in PCB.	AIN	2.5 V	
11	VREGA	Regulated core voltage for the analog circuitry. External capacitor connection for positive reference/supply voltage. Connected in PCB.	AOUT	2.5 V	
12	GND	Ground	GND	0 V	
13	GND	Ground	GND	0 V	
14	VREGD2	Regulated core voltage for the digital circuitry. External capacitor connection for positive reference/supply voltage. Connected in PCB.	AIN	1.5 V	
15	VREGD	Regulated core voltage for the digital circuitry. External capacitor connection for positive reference/supply voltage. Connected in PCB.	AOUT	1.5 V	
16	GND	Ground	GND	0 V	
17	V3P3	External unregulated inputs for the core supply regulators	SUPPLY	3.3 V	
18	VDDIO	Digital supply IO	SUPPLY	3.3 V	
19	MISO	Master In Slave Out (SPI)	DOUT	VDDIO	TRI
20	DRY_SYNC	Sync input (active high) DRY (Data Ready) outputs an interrupt signal for external MCU when the internal output registers (gyroscope + accelerometer) have been updated.	DIN/DOUT	VDDIO	0/PDR
21	SCK	Serial clock (SPI)	DIN	VDDIO	0/PDR
22	CS	Chip select (SPI)	DIN	VDDIO	1/PUR
23	MOSI	Master Out Slave In (SPI)	DIN	VDDIO	0/PDR
24	HEATSINK	Heatsink connection	GND	0 V	

1) Strong PD/PU resistance during device reset state, otherwise weak PD/PU.

### 3.10 Digital I/O specification

Table 11 SPI DC characteristics describes DC characteristics of the SCH16T-K01 SPI I/O pins. Current flowing into the circuit has a positive value.

Table 11 SPI DC characteristics

Title	Symbol	Min	Max	Unit
SPI Voltage Level	VIO	1.7	3.6	V
Input High Voltage	VIH	0.7*VIO	VIO	V
Input Low Voltage	VIL	0	0.3*VIO	V
Input Voltage Hysteresis	VHYST	0.05*VIO		V
Input/Output Capacitance	CIO		10	pF
Total MISO load capacitance, <Wide> range	CLWIDE	10	100	pF
Input pull-down resistance, strong (default)	RPD	60	140	kOhm
Input pull-up resistance, strong (default)	RPU	60	140	kOhm
Input pull-down/pull-up resistance, weak (option)	RPD/RPU	200	400	kOhm
Output leakage current in case MISO is in high impedance condition	ILEAK	-10	10	μA

### 3.11 SPI AC characteristics

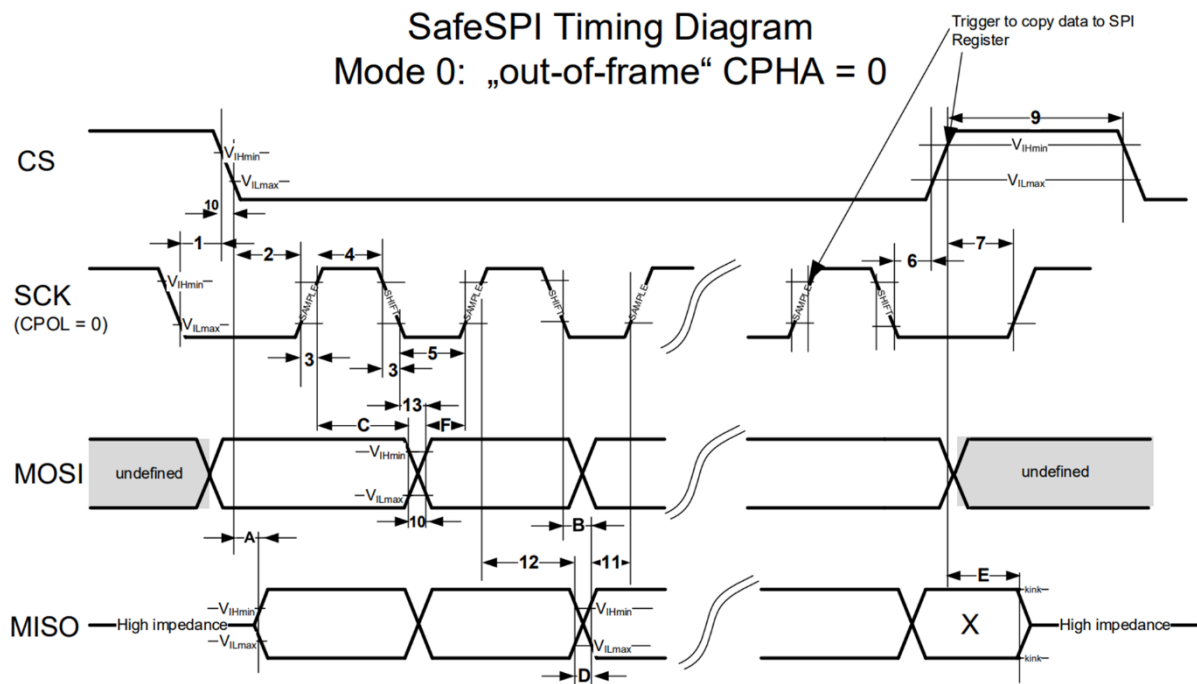

Figure 2 Timing diagram of SPI communication (SPI mode 0), CPOL = 0, CPHA = 0



Table 12 SPI AC electrical characteristics

Title	Remark	Symbol	Min	Max	Unit
SCK Operating Frequency			0.095	10.5	MHz
MISO data valid time (CS)		A		40	ns
MISO data valid time (SCK)		B		32	ns
MOSI data hold time		C	20		ns
MISO rise/fall time	MISO rise/fall time is not defined during transition between high impedance and active mode	D	2	9	ns
MISO data disable lag time		E		50	ns
MOSI data setup time		F	10		ns
SCK disable lead time		1	10		ns
SCK enable lead time		2	40		ns
SCK rise and fall time		3	2	9	
SCK high time		4	37		ns
SCK low time		5	37		ns
SCK enable lag time		6	20		ns
SCK disable lag time		7	10		ns
Sequential transfer delay	In case of MOSI Write commands (RW=1)	9	750		ns
Sequential transfer delay	In case of MOSI Read commands (RW=0)	9	450		ns
MOSI rise and fall time		10	2	9	ns
MOSI data setup time	Setup time of MOSI before the rising edge of SCK	11	5		ns
MISO data hold time		12	X		ns
MOSI valid time		13		10	ns
CS rise and fall time		10	2	9	ns

### 3.12 Measurement axis and directions

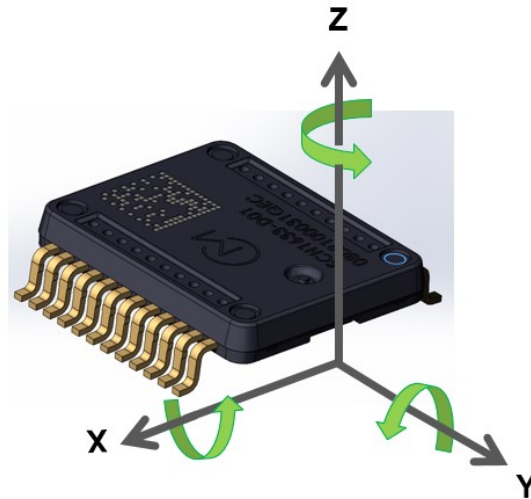

Figure 3 SCH16T-K01 measurement directions for gyroscope and accelerometer

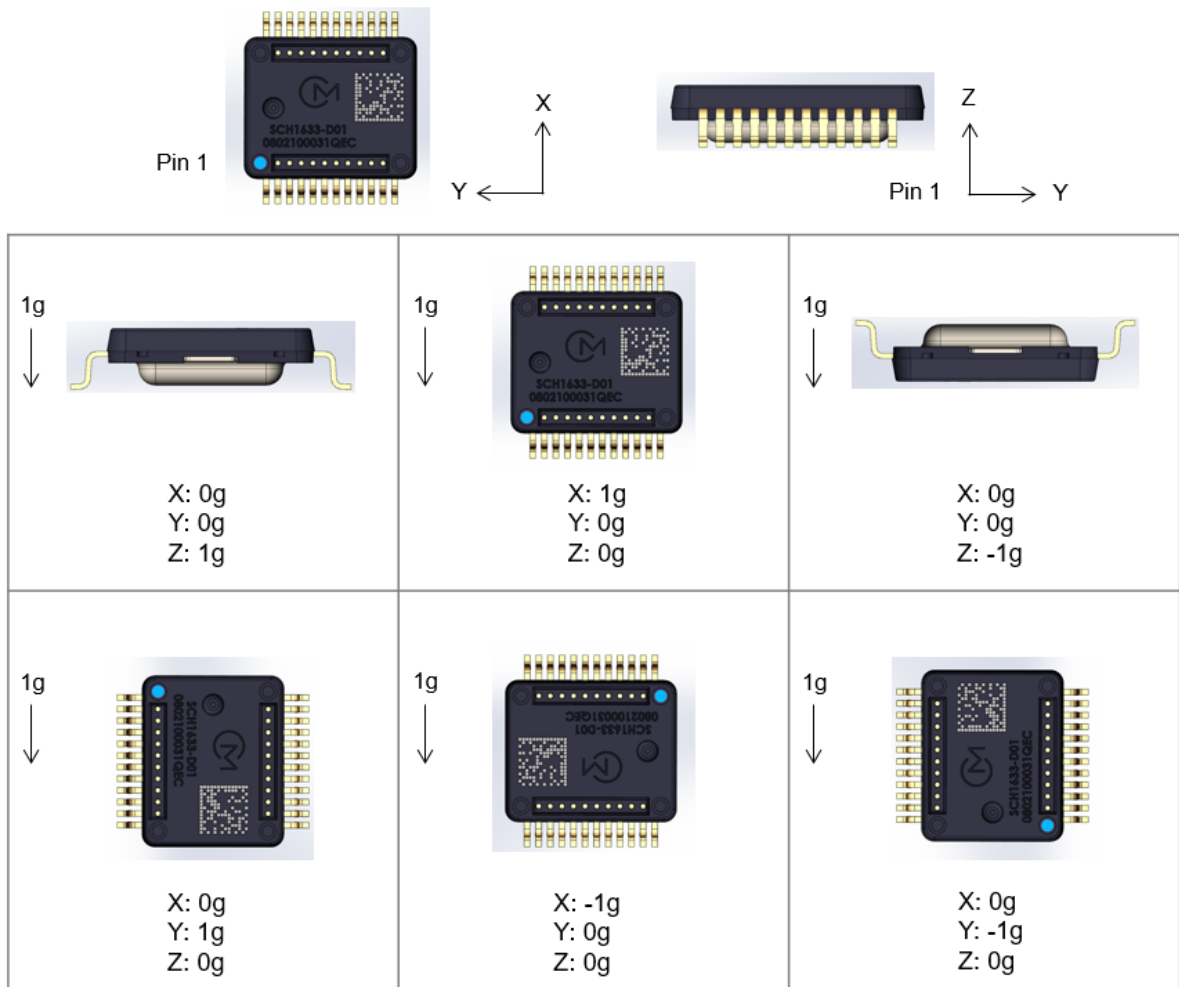

Figure 4 SCH16T-K01 accelerometer measurement directions and outputs. 1g indicates direction of gravity. Note: Pin 1 is marked in blue only in this data sheet to emphasize location.



### 3.14 PCB footprint

SCH16T-K01 PCB footprint dimensions are presented in the table below.

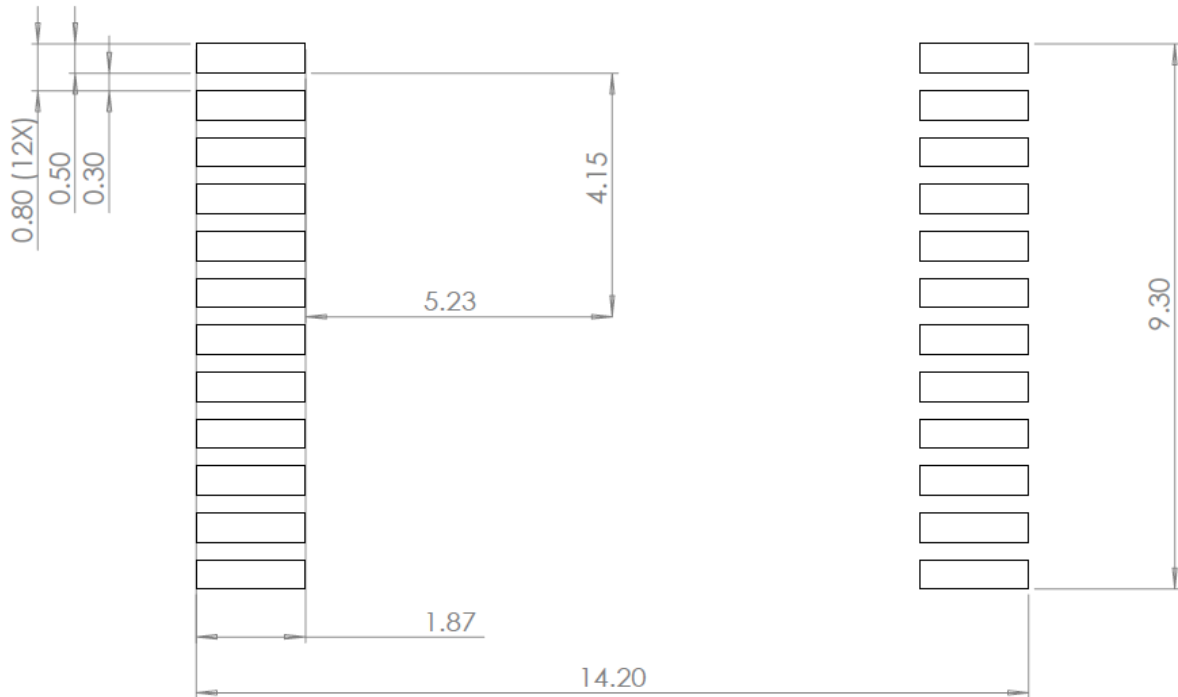

Figure 6 Recommended PCB pad layout for SCH16T. All dimensions are in millimeters.

**This is the end of publicly available document. For full version of this of this data sheet and assembly instructions, please contact Murata.**

*Murata reserves all rights to modify this document without prior notice.*