

emPower

Evaluation and
prototyping platform
for SEGGER software
User Guide & Reference Manual

Document: UM06001
Software Version: 2.00
Revision: A
Date: April 18, 2016



A product of SEGGER Microcontroller GmbH & Co. KG

www.segger.com

Disclaimer

Specifications written in this document are believed to be accurate, but are not guaranteed to be entirely free of error. The information in this manual is subject to change for functional or performance improvements without notice. Please make sure your manual is the latest edition. While the information herein is assumed to be accurate, SEGGER Microcontroller GmbH & Co. KG (SEGGER) assumes no responsibility for any errors or omissions. SEGGER makes and you receive no warranties or conditions, express, implied, statutory or in any communication with you. SEGGER specifically disclaims any implied warranty of merchantability or fitness for a particular purpose.

Copyright notice

You may not extract portions of this manual or modify the PDF file in any way without the prior written permission of SEGGER. The software described in this document is furnished under a license and may only be used or copied in accordance with the terms of such a license.

© 2015 - 2016 SEGGER Microcontroller GmbH & Co. KG, Hilden / Germany

Trademarks

Names mentioned in this manual may be trademarks of their respective companies.

Brand and product names are trademarks or registered trademarks of their respective holders.

Contact address

SEGGER Microcontroller GmbH & Co. KG

In den Weiden 11

D-40721 Hilden

Germany

Tel. +49 2103-2878-0

Fax. +49 2103-2878-28

E-mail: support@segger.com

Internet: www.segger.com

Manual versions

This manual describes the current hardware version. If you find an error in the manual or a problem in the hardware, please inform us and we will try to assist you as soon as possible. Contact us for further information on topics or functions that are not yet documented.

Print date: April 18, 2016

Revision	Date	By	Description
2	160418	RH	Chapter "Ethernet connector" added. Minor improvements & corrections.
1	160108	RH	Schematics added.
0	151015	DA	Initial Release.

About this document

Assumptions

This document assumes that you already have a solid knowledge of the following:

- The software tools used for building your application (assembler, linker, C compiler).
- The C programming language.
- The target processor.
- DOS command line.

If you feel that your knowledge of C is not sufficient, we recommend *The C Programming Language* by Kernighan and Richie (ISBN 0-13-1103628), which describes the standard in C programming and, in newer editions, also covers the ANSI C standard.

How to use this manual

This manual explains all the functions and macros that the product offers. It assumes you have a working knowledge of the C language. Knowledge of assembly programming is not required.

Typographic conventions for syntax

This manual uses the following typographic conventions:

Style	Used for
Body	Body text.
Keyword	Text that you enter at the command prompt or that appears on the display (that is system functions, file- or pathnames).
Parameter	Parameters in API functions.
Sample	Sample code in program examples.
Sample comment	Comments in program examples.
Reference	Reference to chapters, sections, tables and figures or other documents.
GUI Element	Buttons, dialog boxes, menu names, menu commands.
Emphasis	Very important sections.

Table of contents

1	Introduction to emPower	8
1.1	Overview on Hardware features and specifications	9
2	Functional Description	11
2.1	Freescle Kinetis K66 MCU (MK66FN2M0VMD18)	12
2.2	USB Connectors	13
2.2.1	Hi-Speed USB (HS USB)	13
2.2.2	USB HOST	13
2.2.3	J-Link OB and alternative Debug Access	13
2.3	Ethernet connector	14
2.4	Storage Devices	15
2.4.1	Macronix NAND Flash (MX30LF1GE8ABTI)	15
2.4.2	Micro SD card	15
2.5	Display adapter connector (J504)	16
2.6	Expansion IF Module Connectors (J500-502)	17
2.7	Pin Headers (J505-506)	19
2.8	Joystick, user/reset buttons, rotary input, LEDs	20
2.9	Power Supply	21
3	Schematics	23
3.1	MCU	24
3.2	ETH, HS, USB, USB Host	25
3.3	IO, NAND Flash	26
3.4	J-Link OB, Power Supply	27

Chapter 1

Introduction to emPower

This section presents an overview of emPower, its structure, and its capabilities.

emPower is a dedicated demonstrator board providing the means for customers to evaluate and experience SEGGER's superior embedded middleware products. The board has a NXP Kinetis K66 microcontroller. It is designed without jumpers and configuration switches to easily illustrate the extensive capabilities of SEGGER's high-performance, feature rich software such as emFile (file system), embOS (RTOS), embOS/IP (IP stack), emModbus (Modbus stack), emWin (graphic library with GUI), or emUSB Device + Host (USB stacks).

The software evaluation package including these products is available for download here: <https://www.segger.com/empower.html>

This document is designed to give a quick overview on the features and specifications of the emPower board. If you are looking for a detailed description of SEGGER's middleware products, please refer to the individual product sites at <https://www.segger.com>

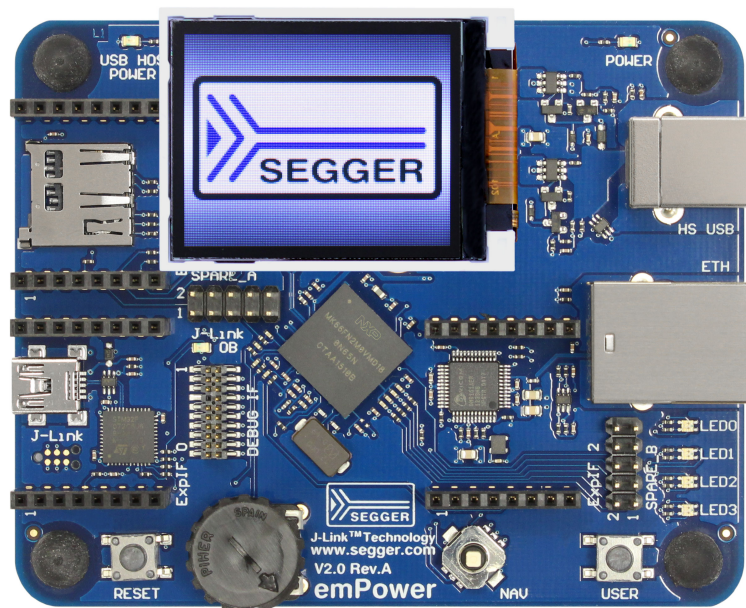

1.1 Overview on Hardware features and specifications

- NXP Kinetis K66 microcontroller (MK66FN2M0VMD18)
- Macronix SLC 1 GBit NAND Flash (MX30LF1GE8ABTI)
- On-board debug probe J-Link-OB with Drag & Drop (STM32F072, Mini A/B-type connector); SWD/SWO only, CDC/VCOM port support
- External debug interface (19-pin Cortex-M); incl. trace
- Fast Ethernet
- Micro SD card connector
- Display adapter connector (5 V/3.3 V, SPI, PWM for backlight control)
- USB device: High speed, B-type connector (as on J-Link)
- USB host: Full speed, providing USB supply to device, A-Type receptacle (for directly plugging in A-Type devices/modules)
- 3 expansion interfaces providing I2C, SPI buses, UART, GPIO/timer, analog input, power; compatible to 3.3 V SExI modules (comp. <http://soldercore.com/data/SenseCore/SenseCore.pdf>)
- Joystick 4(+1)-way, 1x "FIRE" button, 1x RESET button
- Rotary input (potentiometer to ADC)
- LEDs: 4x BiColor red/green
- Pin headers for spare MCU signals
- Easy to set up (No jumpers or solder jumpers)
- Dimensions 99 mm x 80 mm

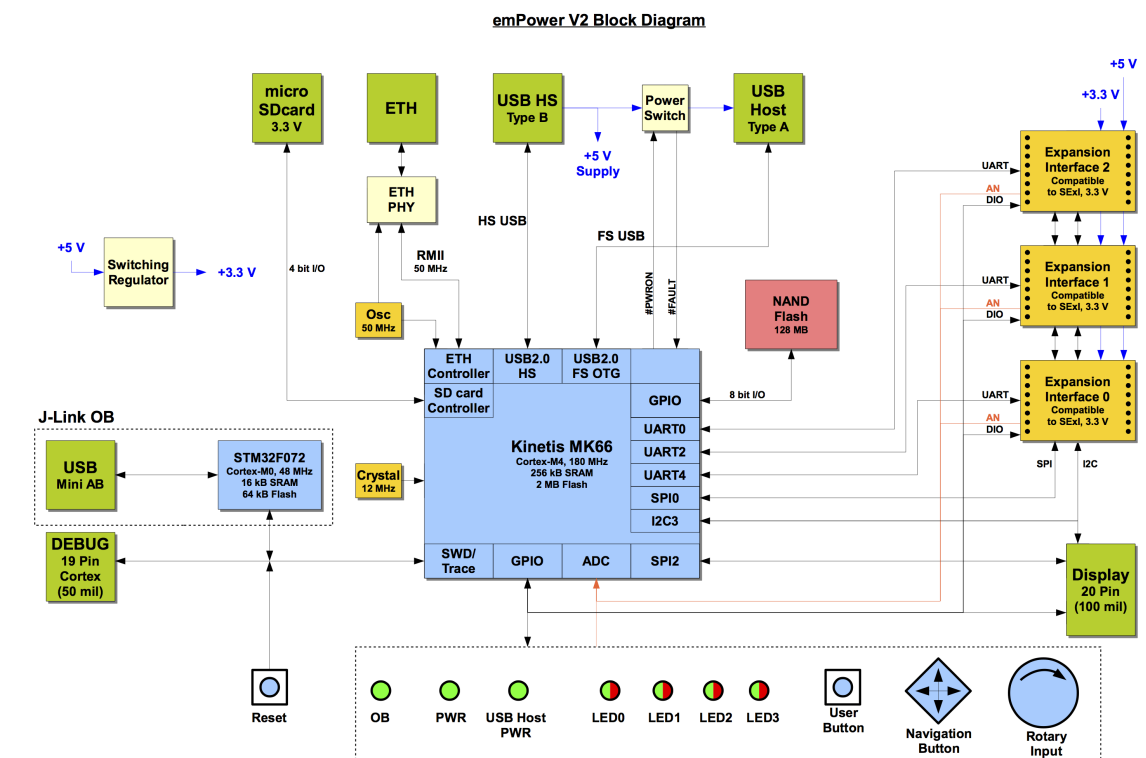

Chapter 2

Functional Description

This section describes the hardware features from a functional point of view.

2.1 Freescale Kinetis K66 MCU (MK66FN2M0VMD18)

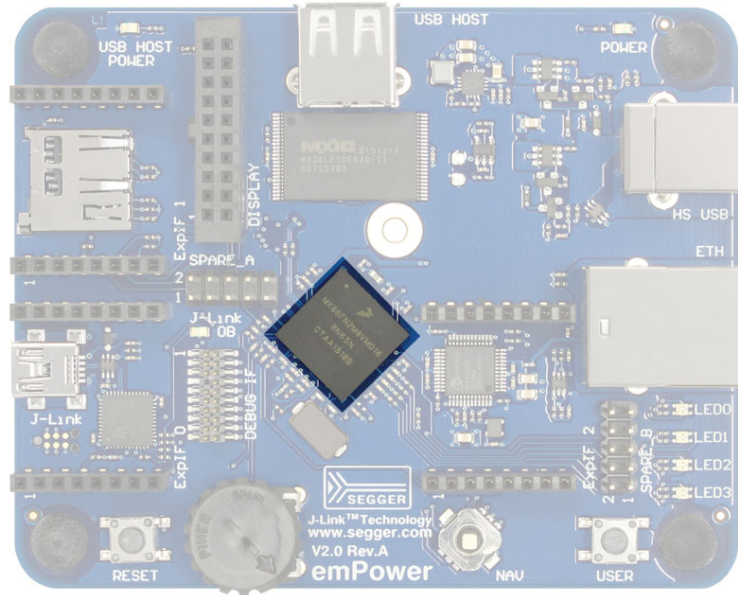

The microcontroller used on the emPower board is a NXP K66 device. It is clocked at 180 MHz and comes with 256 KB SRAM as well as 2 MB Flash memory. Peripheral functions provided include two USB2.0 controllers with an integrated HS USB PHY, controllers for Ethernet and SDHC, 16 bit ADC, and several SPI/I2C/CAN/UART units.

2.2 USB Connectors

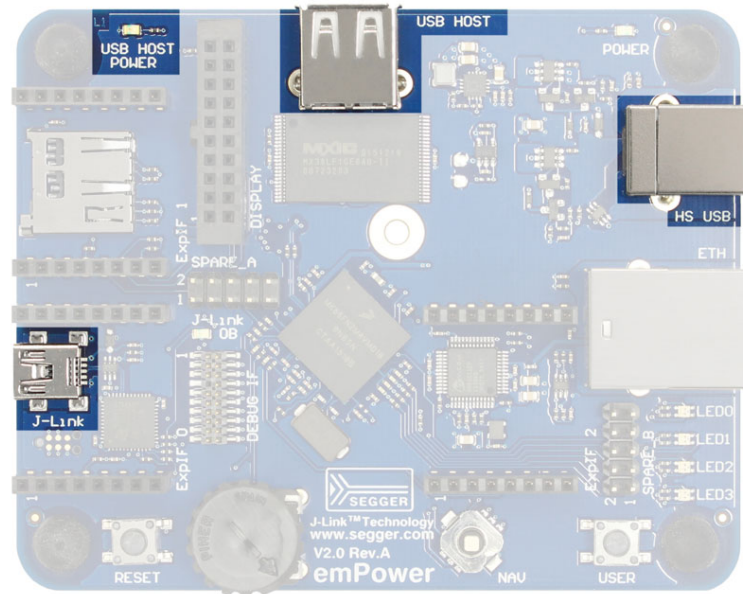

2.2.1 Hi-Speed USB (HS USB)

The Hi-Speed USB connector is the main USB connection to a host. emPower provides Hi-Speed USB 2.0 device functionality.

2.2.2 USB HOST

The USB HOST provides USB2.0 FS host functionality to a connected device. If this host port is switched on the green "USB HOST POWER" LED is on.

2.2.3 J-Link OB and alternative Debug Access

Quick and easy debug access to the Kinetis microcontroller can be achieved by the J-Link OB, SEGGER's on-board debug probe. It connects through a USB2.0 FS interface to the debug host. Alternatively regular debug probes from the J-Link series (J-Link BASE/PLUS/ULTRA+/PRO) can be used by means of a Cortex-M debug connector (DEBUG IF, 19 pole, pitch 50 mil). For the connector pinout see <https://www.segger.com/jlink-adapters-19pin-cortexm.html>

2.3 Ethernet connector

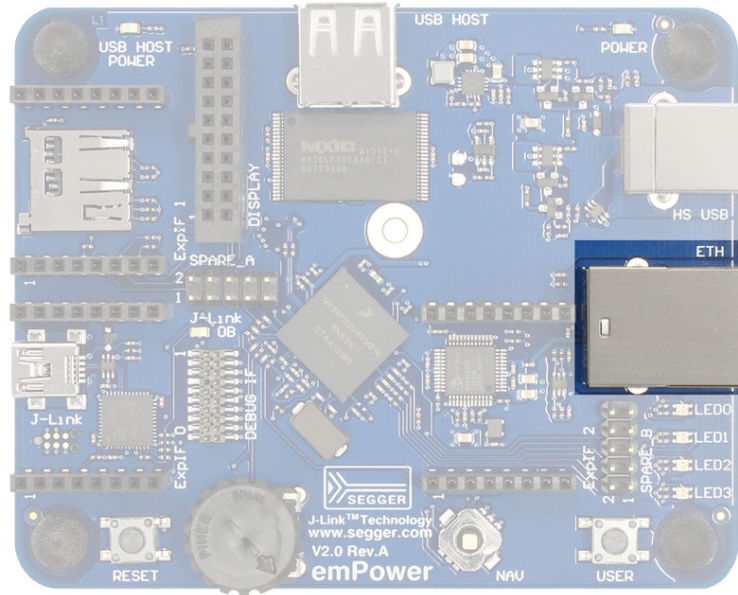

emPower provides 100 MBit fast Ethernet functionality with a RF45 connector. The Ethernet PHY is connected to the K66 MCU via RMI interface.

2.4 Storage Devices

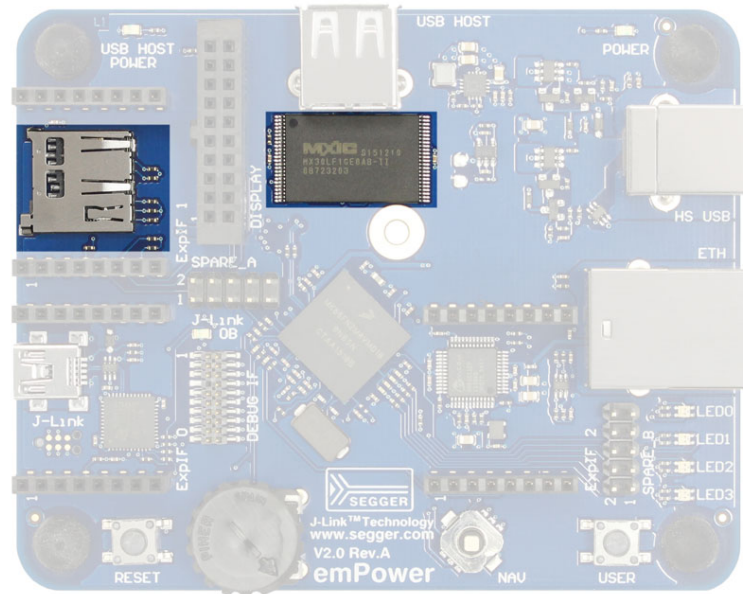

2.4.1 Macronix NAND Flash (MX30LF1GE8ABTI)

Nonvolatile storage capability on emPower V2 is achieved by means of a 1 Gb (128 MB) SLC NAND Flash from Macronix, a leading integrated device manufacturer in the Non-volatile Memory (NVM) market, (part type MX30LF1GE8ABTI). The NAND flash has a built-in ECC controller and therefore presents itself as ECC-free to the driving MCU.

2.4.2 Micro SD card

A micro SD card slot is included on the board, SD card operating voltage is 3.3 V.

2.5 Display adapter connector (J504)

Small TFT displays can be connected to emPower V2 using a simple adapter board providing the connector for the FPC cable of a dedicated display. Display control is restricted to SPI capable controllers and a 3.3 V single supply. 5 V is provided for driving a white backlight LED as well as a PWM signal for backlight dimming. For touch control an I2C connection is routed to this connector too.

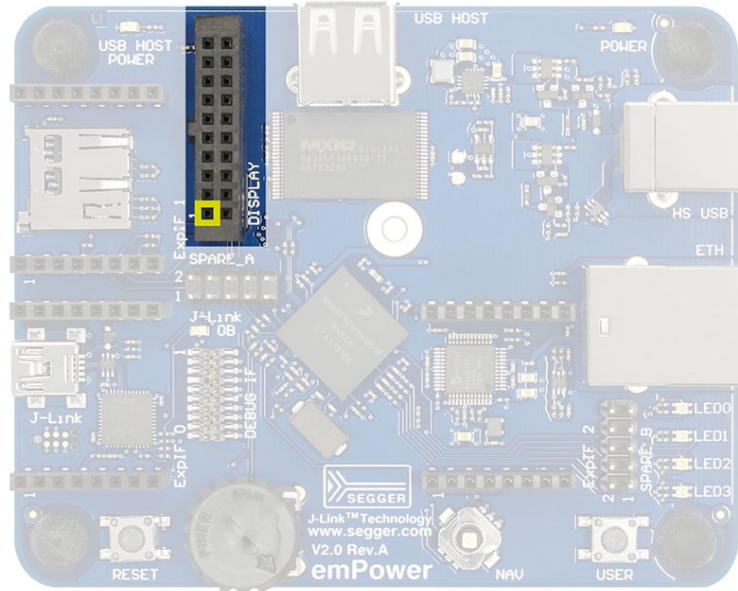

Connection Table DISPLAY/J504 (2x 10 pole 100 mil receptacle):

GPIO-Pin	SIGNAL	Header	Header	SIGNAL	GPIO-Pin
PTB18	BLON/PWM	Pin 1	Pin 2	VCC5V	
PTB11	#RESET	Pin 3	Pin 4	VCC3V3	
PTB19	D/#C	Pin 5	Pin 6	VCC3V3	
PTB8	SPARE0	Pin 7	Pin 8	I2C3_SDA	PTE10
PTB9	SPARE1	Pin 9	Pin10	I2C3_SCL	PTE11
PTB10	SPARE2	Pin11	Pin12	GND	
PTB22	SPI2_MOSI	Pin13	Pin14	GND	
PRB23	SPI2_MISO	Pin15	Pin16	GND	
PTB21	SPI2_SCK	Pin17	Pin18	GND	
PRB20	SPI2_#CS	Pin19	Pin20	GND	

2.6 Expansion IF Module Connectors (J500-502)

emPower V2 can carry up to three expansion boards for pulling in additional functions, for example CAN/UART transceivers or sensor modules. Mechanical dimensions and pin out of these connectors are compatible to 3.3 V SExI modules, see <http://soldercore.com> for additional information. Each module connector consists of 2x 8 pole 100 mil receptacles and provides I2C, SPI, UART, a GPIO/timer, an analog input, and power.

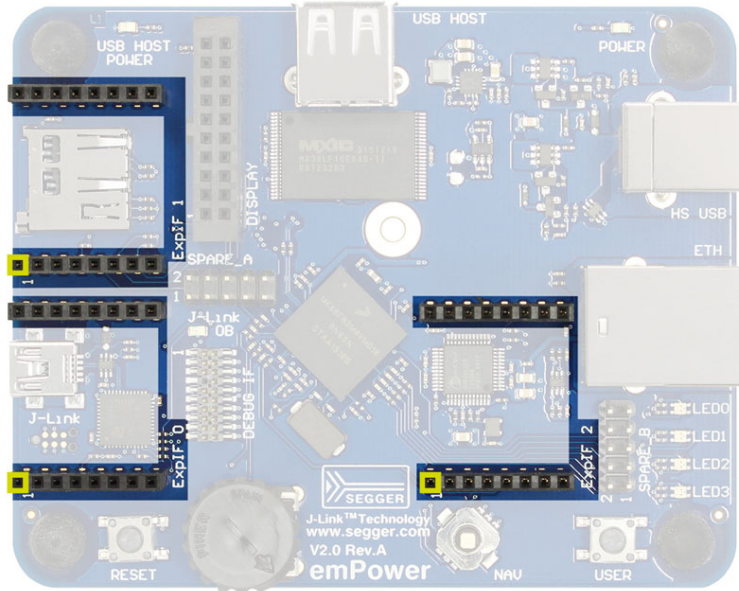

Connection Table EXPIF_0/J500:

GPIO-Pin	SIGNAL	Header	Header	SIGNAL	GPIO-Pin
PTC5	SPI0_SCK	Pin 1	Pin16	UART4_TX	PTE24
PTC6	SPI0_MOSI	Pin 2	Pin15	VCC5V	
PTC7	SPI0_MISO	Pin 3	Pin14	VCC3V3	
PTC4	SPI0_#CS0	Pin 4	Pin13	GND	
	ADC1_DP0/ ADC0_DP3	Pin 5	Pin12	UART4_RX	PTE25
PTE10	I2C3_SDA	Pin 6	Pin11	VCC5V	
PTE11	I2C3_SCL	Pin 7	Pin10	VCC3V3	
PTE7	GPIO/PWM	Pin 8	Pin 9	GND	

Connection EXPIF_1/Table J501:

GPIO-Pin	SIGNAL	Header	Header	SIGNAL	GPIO-Pin
PTC5	SPI0_SCK	Pin 1	Pin16	UART2_TX	PTD3
PTC6	SPI0_MOSI	Pin 2	Pin15	VCC5V	
PTC7	SPI0_MISO	Pin 3	Pin14	VCC3V3	
PTC3	SPI0_#CS1	Pin 4	Pin13	GND	
	ADC0_SE16/ ADC0_SE21	Pin 5	Pin12	UART2_RX	PTD2
PTE10	I2C3_SDA	Pin 6	Pin11	VCC5V	
PTE11	I2C3_SCL	Pin 7	Pin10	VCC3V3	
PTE8	GPIO/PWM	Pin 8	Pin 9	GND	

Connection Table EXPIF_3/J502:

GPIO-Pin	SIGNAL	Header	Header	SIGNAL	GPIO-Pin
PTC5	SPI0_SCK	Pin 1	Pin16	UART0_TX	PTB17
PTC6	SPI0_MOSI	Pin 2	Pin15	VCC5V	
PTC7	SPI0_MISO	Pin 3	Pin14	VCC3V3	
PTC2	SPI0_#CS2	Pin 4	Pin13	GND	
	ADC1_SE16/ ADC0_SE22	Pin 5	Pin12	UART0_RX	PTB16
PTE10	I2C3_SDA	Pin 6	Pin11	VCC5V	
PTE11	I2C3_SCL	Pin 7	Pin10	VCC3V3	
PTE9	GPIO/PWM	Pin 8	Pin 9	GND	

2.7 Pin Headers (J505-506)

All spare MCU signals are accessible via a 2x 5 pole 100 mil pin header.

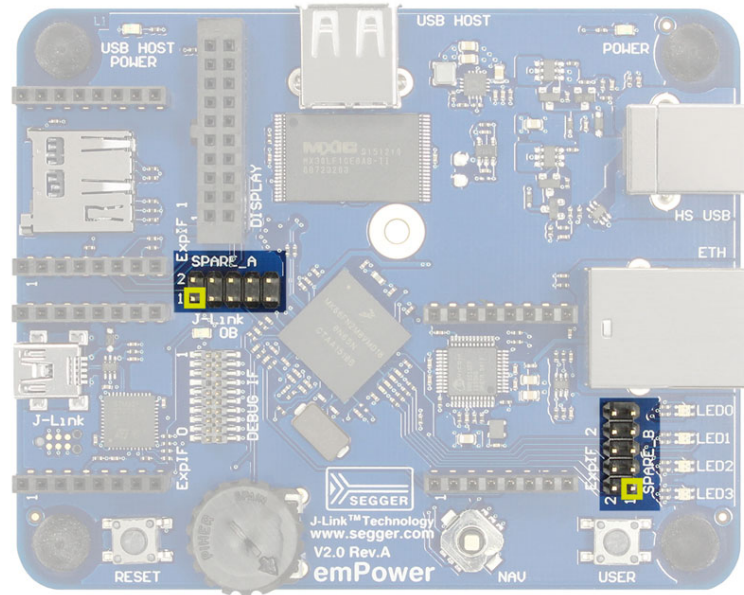

Connection Table SPARE_A/J505:

GPIO-Pin	SIGNAL	Header	Header	SIGNAL	GPIO-Pin
PTA5		Pin 1	Pin 2		PTA24
PTA25		Pin 3	Pin 4		PTA26
PTA27		Pin 5	Pin 6		PTA28
PTA29		Pin 7	Pin 8		PTB3
	GND	Pin 9	Pin10	VCC3V3	

Connection Table SPARE_B/J506:

GPIO-Pin	SIGNAL	Header	Header	SIGNAL	GPIO-Pin
	ADC1_SE10 (ball G10)	Pin 1	Pin 2	ADC1_SE11 (ball G9)	
	ADC1_SE12 (ball F12)	Pin 3	Pin 4	ADC1_SE13 (ball F11)	
PTE27		Pin 5	Pin 6		PTA11
- (nc)	-(nc)	Pin 7	Pin 8	-(nc)	-(nc)
	GND	Pin 9	Pin10	VCC3V3	

2.8 Joystick, user/reset buttons, rotary input, LEDs

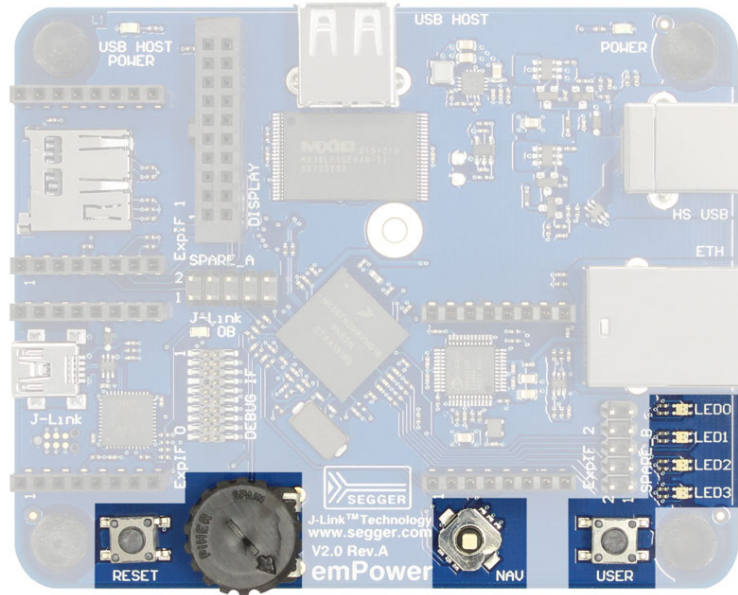

The joystick (NAV) is a five-way navigation switch connecting to MCU GPIO port C. Idle state is high.

Connection Table:

Direction	GPIO
"UP"	PTC15
"DOWN"	PTC16
"LEFT"	PTC14
"RIGHT"	PTC17
"PUSH"	PTC18

The user button (USER) connects to PTC19. Idle state is high.

The reset buttons (RESET) performs a hard reset of the MCU if pressed.

The rotary input is a potentiometer generating an analog voltage for ADC0 input SE23 (ball L3).

4 bi-color (red/green) user LEDs are connected to MCU GPIO port C. LED off state is high.

Connection Table:

LED	Color	GPIO
LED0	red	PTC13
LED0	green	PTC12
LED1	red	PTC11
LED1	green	PTC10
LED2	red	PTC9
LED2	green	PTC8
LED3	red	PTC1
LED3	green	PTC0

2.9 Power Supply

The emPower V2 board is powered by USB only. There are two USB device ports, Main USB (B-type connector, HS USB) and J-Link OB USB (Mini USB connector), which both can be used for this purpose in any combination (Main USB, OB USB, both). Current consumption drawn strongly depends on the application and connected peripherals. Idle consumption is approx. 85 mA. If the board is powered, the green "POWER" LED is on.

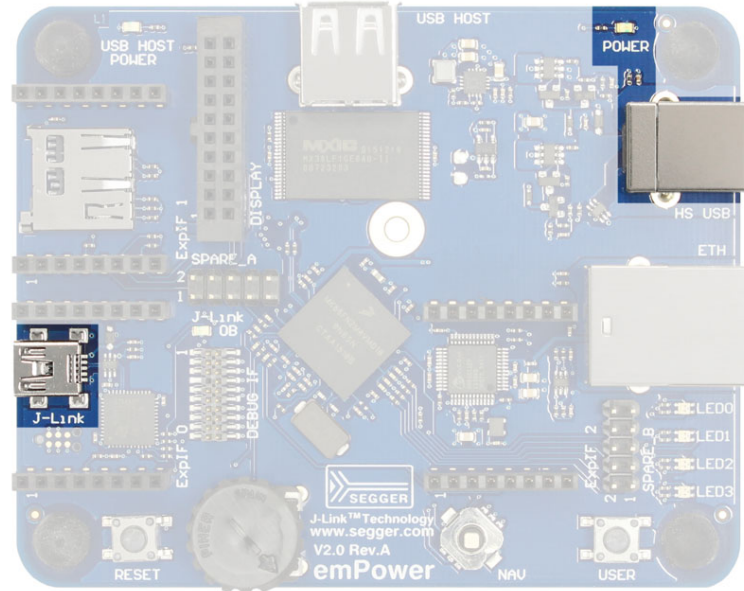

Chapter 3

Schematics

This section contains the emPower schematics.

3.2 ETH, HS, USB, USB Host

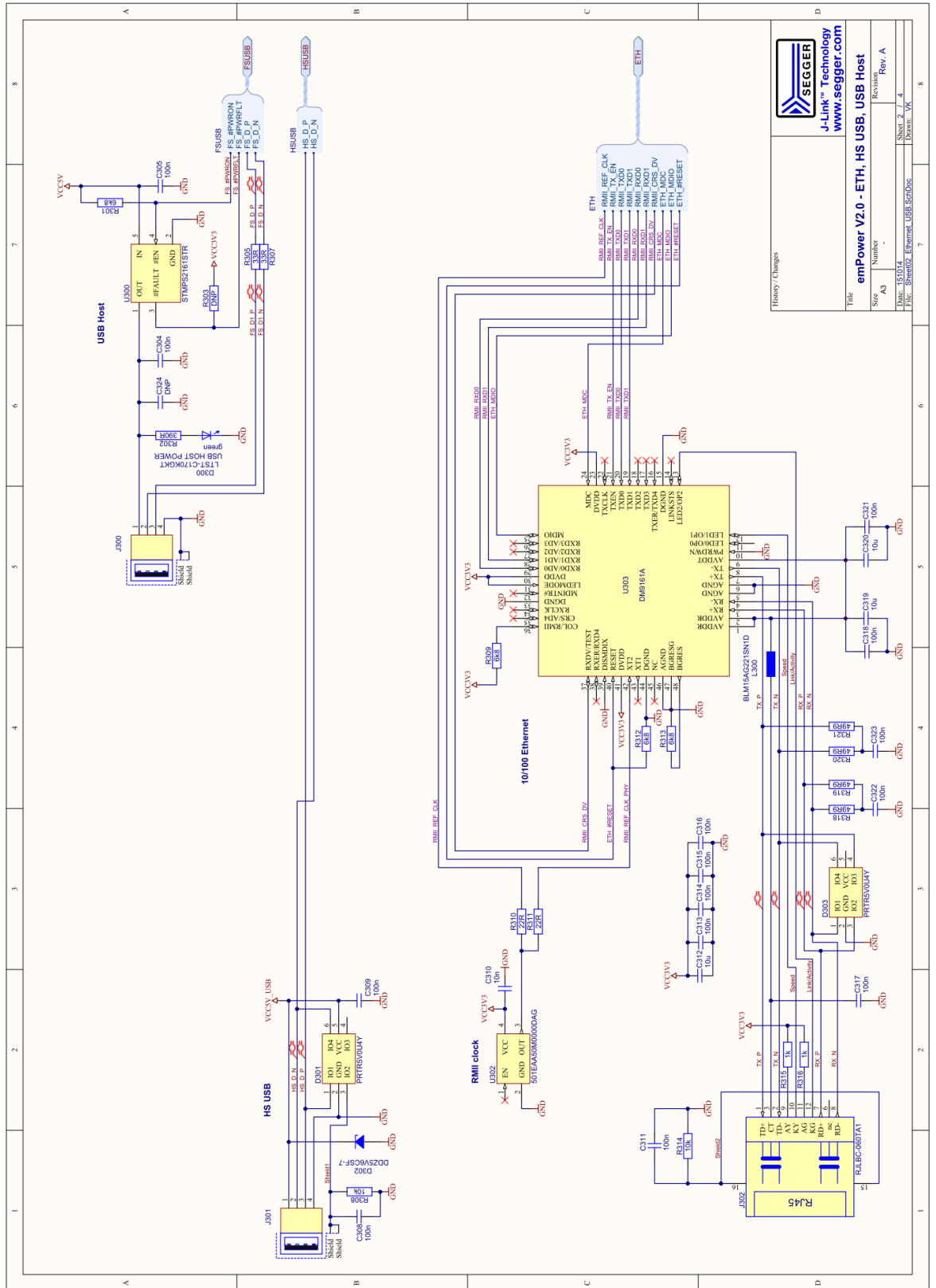

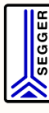
J-Link™ Technology
www.segger.com

Title		emPower V2.0 - ETH, HS USB, USB Host	
Size	Number	Revision	Rev. A
Date:	15.01.14	Sheet:	2 / 4
File:	SEGGER_Ethernet_USB5650z	Drawn:	VK

3.4 J-Link OB, Power Supply

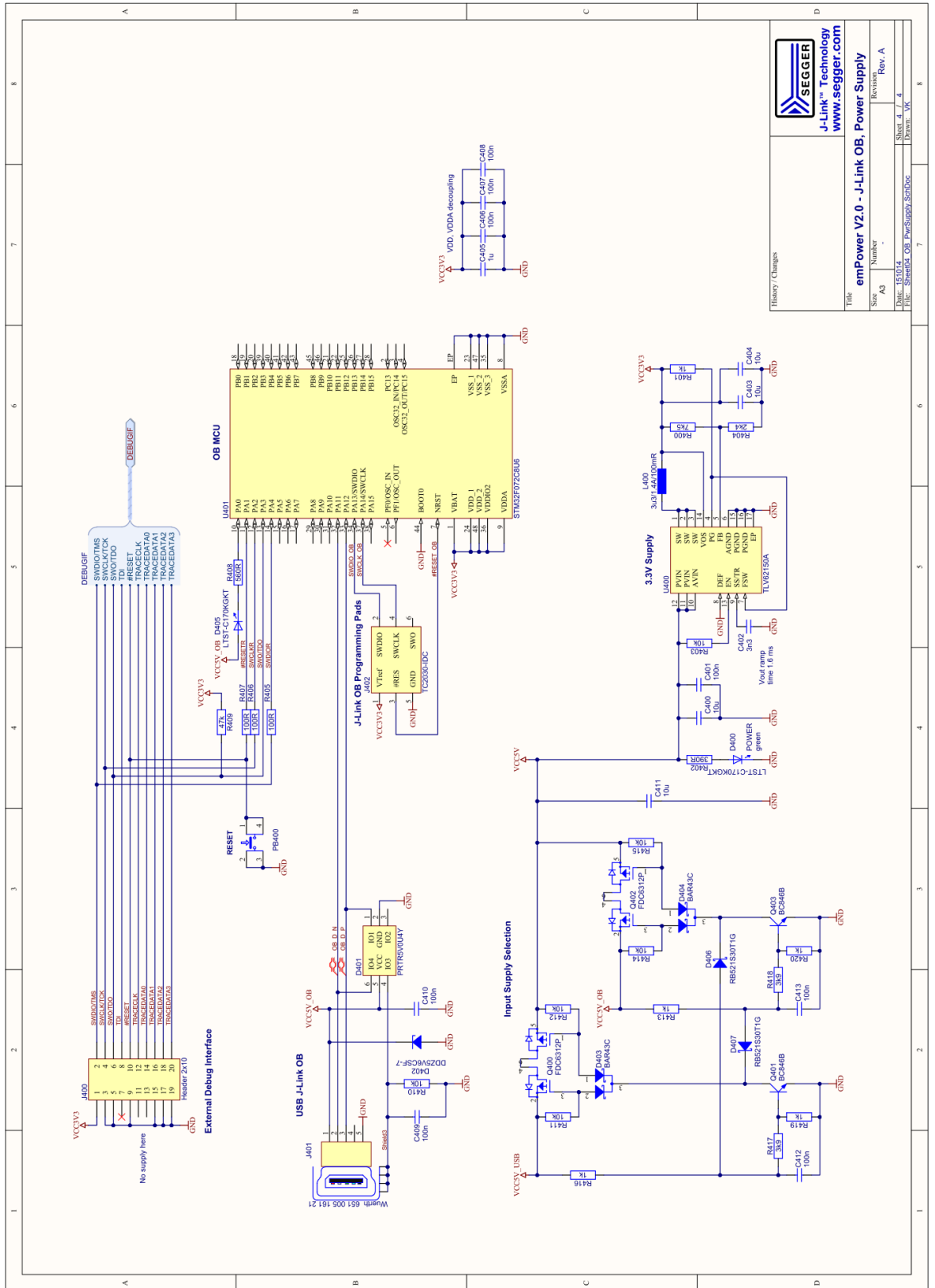

SEGGER
J-Link™ Technology
www.segger.com

History / Changes

Title	emPower V2.0 - J-Link OB, Power Supply		
Size	Number	Revision	Rev. A
Date:	15.01.14	Sheet:	4 / 4
File:	Segger_OB_PwrSupply_SchDoc	Drawn:	VK

Mouser Electronics

Authorized Distributor

Click to View Pricing, Inventory, Delivery & Lifecycle Information:

[Segger Microcontroller:](#)

[6.30.00](#)