

# Manual Motor Starter (Motor Protection Circuit Breaker) J7MC Series

## MPCB system, protection from Overload, Phase failure and Short Circuit



- Push-In Plus wiring Technology saves Wiring and Maintenance time
- In combination with magnetic contactor model J7KC, it is ideal for control of motors to AC-3 class, 2.2 kW (200 to 240 VAC) \* or 5.5 kW (380 to 440 VAC).
- Rocker switch (standard type) and rotary switch (high-performance type)
- High breaking capacity (Max100 kA/440 VAC)
- Equipped with a dial cover as standard to protect accidental setting changes.  
Lockable with a padlock to ensure safety at startup
- Certified as compliant with the main safety standards



For the most recent information on models that have been certified for safety standards, refer to your OMRON website.

\* Based on JIS C 8201-4-1

Refer to *Safety Precautions* on page 12.

## Model Number Structure

**Model Number Legend** Order according to the format described in Ordering Information.

**J7MC- 3**   -     
 (1) (2) (3)

### (1) Number of poles

Code	Number of poles
3	3

### (2) Breaking capacity

Code	Switch type
P	Rocker switch (Standard type)
R	Rotary switch (High-performance type)

### (3) Rated current

Code	Rated current
E16	0.16 A
E25	0.25 A
E4	0.4 A
E63	0.63 A
1	1 A
1E6	1.6 A
2E5	2.5 A
4	4 A
6	6.3 A
10	10 A
13	13 A
16	16 A
20	20 A

# J7MC Series

## Ordering Information

### Main unit

#### Rocker switch (standard type)

Rated current (A) (Values in ( ) are the current setting range)	Model
0.16 (0.1-0.16)	J7MC-3P-E16
0.25 (0.16-0.25)	J7MC-3P-E25
0.40 (0.25-0.4)	J7MC-3P-E4
0.63 (0.4-0.63)	J7MC-3P-E63
1 (0.63-1)	J7MC-3P-1
1.6 (1-1.6)	J7MC-3P-1E6
2.5 (1.6-2.5)	J7MC-3P-2E5
4 (2.5-4)	J7MC-3P-4
6.3 (4-6.3)	J7MC-3P-6
10 (6.3-10)	J7MC-3P-10
13 (9-13)	J7MC-3P-13
16 (11-16)	J7MC-3P-16
20 (14-20)	J7MC-3P-20

#### Rotary switch (high-performance type)

Rated current (A) (Values in ( ) are the current setting range)	Model
0.16 (0.1-0.16)	J7MC-3R-E16
0.25 (0.16-0.25)	J7MC-3R-E25
0.40 (0.25-0.4)	J7MC-3R-E4
0.63 (0.4-0.63)	J7MC-3R-E63
1 (0.63-1)	J7MC-3R-1
1.6 (1-1.6)	J7MC-3R-1E6
2.5 (1.6-2.5)	J7MC-3R-2E5
4 (2.5-4)	J7MC-3R-4
6.3 (4-6.3)	J7MC-3R-6
10 (6.3-10)	J7MC-3R-10
13 (9-13)	J7MC-3R-13
16 (11-16)	J7MC-3R-16
20 (14-20)	J7MC-3R-20

### Options (Order Separately)

#### Auxiliary contact unit

Model	Auxiliary contact
J73MC-W-10	SPST-1NO
J73MC-W-01	SPST-1NC

#### Alarm contact unit

Model	Auxiliary contact
J73MC-K-10	SPST-1NO
J73MC-K-01	SPST-1NC

#### Insulation stop

	Model	Minimum order (bag)
For main unit	J77MC-A	1 (10 pcs./bag)
For optional unit (For auxiliary contact unit and alarm contact unit)	J77MC-B	

## Ratings/Specifications

### J7MC-3P-□ (standard type)

Rated current *2 In [A]	Current setting range Rated operating current [A]	Instantaneous trip current [A]	3-phase standard motor capacity and full load current *1				Rated breaking current Icu [kA]				
			200-240 VAC		380-440 VAC		240 VAC	415 VAC	440 VAC		
			Capacity [kW]	Current [A]	Capacity [kW]	Current [A]					
0.16	0.1 to 0.16	2.1	---	---	0.02	0.1	100	100	100		
0.25	0.16 to 0.25	3.3	0.03	0.24	0.06	0.21					
0.4	0.25 to 0.4	5.2	0.06	0.37	0.1	0.34					
0.63	0.4 to 0.63	8.2	---	---	0.12	0.41					
1	0.63 to 1	13	0.1	0.68	0.2	0.65					
1.6	1 to 1.6	20.8	0.2	1.3	0.4	1.15					
2.5	1.6 to 2.5	32.5	0.4	2.3	0.75	1.8					
4	2.5 to 4	52	0.75	3.5	1.5	3.5					
6.3	4 to 6.3	81.9	---	---	2.2	4.8					
10	6.3 to 10	130	1.5	6.9	3.7	7.8					
			2.2	9.5							
13	9 to 13	169	2.2	9.5	5.5	10.5				50	10
16	11 to 16	208	3.7	15.5	7.5	13.5				25	
20	14 to 20	260	3.7	15.5	11	20	50				

### J7MC-3R-□ (high-performance type)

Rated current *2 In [A]	Current setting range Rated operating current [A]	Instantaneous trip current [A]	3-phase standard motor capacity and full load current *1				Rated breaking current Icu [kA]				
			200-240 VAC		380-440 VAC		240 VAC	415 VAC	440 VAC		
			Capacity [kW]	Current [A]	Capacity [kW]	Current [A]					
0.16	0.1 to 0.16	2.1	---	---	0.02	0.1	100	100	100		
0.25	0.16 to 0.25	3.3	0.03	0.24	0.06	0.21					
0.4	0.25 to 0.4	5.2	0.06	0.37	0.1	0.34					
0.63	0.4 to 0.63	8.2	---	---	0.12	0.41					
1	0.63 to 1	13	0.1	0.68	0.2	0.65					
1.6	1 to 1.6	20.8	0.2	1.3	0.4	1.15					
2.5	1.6 to 2.5	32.5	0.4	2.3	0.75	1.8					
4	2.5 to 4	52	0.75	3.5	1.5	3.5					
6.3	4 to 6.3	81.9	---	---	2.2	4.8					
10	6.3 to 10	130	1.5	6.9	3.7	7.8					
			2.2	9.5							
13	9 to 13	169	2.2	9.5	5.5	10.5				50	35 *3
16	11 to 16	208	3.7	15.5	7.5	13.5					
20	14 to 20	260	3.7	15.5	11	20					

\*1. Full load currents are values for 200 VAC / 50 Hz, 400 VAC / 50 Hz, 4P reference motors.

Before applying them, check the full load current of the motor used.

\*2. Maximum thermal current setting value

\*3. JEM1195 breaking duty "O", single time breaking capacity is 50 kA.

# J7MC Series

## Ratings/Characteristics

Model		J7MC-3P-□ (standard type)										J7MC-3R-□ (high-performance type)													
Item																									
Switch type		Rocker switch										Rotary switch													
Number of poles		3																							
Rated current I <sub>n</sub>		0.16 to 20 A																							
Rated operational voltage U <sub>e</sub>		200 to 690 V																							
Rated frequency		50/60 Hz																							
Rated insulation voltage		690VAC																							
Rated impulse dielectric strength		6 kV																							
Use category	IEC 60947-2 (circuit breaker), JIS C 8201-2	Cat.A																							
	IEC 60947-4-1 (motor starter), JIS C 8201-4-1	AC-3																							
Trip class (IEC 60947-4-1/JIS C 8201-4-1)		10 Trips within 4 minutes at 150% I <sub>e</sub> on hot start, trips in 4 to 10 seconds at 720% I <sub>e</sub> on cold start																							
Instantaneous trip characteristics		13 x I <sub>e</sub> max.																							
Power loss (3-phase reference value)		Rated current 0.16 to 2.5 A: 6 W Rated current 4 to 6.3 A: 6.5 W Rated current 10 to 20 A: 7 W										Rated current 0.16 to 1.6 A: 6 W Rated current 2.5 to 4 A: 6.5 W Rated current 6.3 to 20 A: 7 W													
Endurance	Mechanical	100,000 cycles I <sub>n</sub> =0.16 to 20 A																							
	Electrical	100,000 cycles I <sub>n</sub> =0.16 to 20 A																							
Number of terminal insertions and removals [cycles]		20																							
Maximum operate frequency (motor starts) [cycles/hour]		25																							
Phase failure protection		Yes																							
Trip indicator		Yes																							
Test trip function		Yes																							
Rated limit breaking capacity I <sub>cu</sub> : Rated limit breaking capacity [kA] (Breaking duty O-CO) I <sub>cs</sub> : Rated operating breaking capacity [kA] (Breaking duty O-CO-CO) I <sub>cs</sub> =100%I <sub>cu</sub> (I <sub>cu</sub> =100 kA)	Rated operational current I <sub>e</sub> Current setting [A]	IEC 60947-2/JIS C 8201-2										UL		IEC 60947-2/JIS C 8201-2						UL					
		240 V 200 V		415 V 400 V		460 V 440 V		500 V		690 V 600 V		480 V		240 V 200 V		415 V 400 V		460 V 440 V		500 V		690 V 600 V		480 V	
		I <sub>cu</sub>	I <sub>cs</sub>	I <sub>cu</sub>	I <sub>cs</sub>	I <sub>cu</sub>	I <sub>cs</sub>	I <sub>cu</sub>	I <sub>cs</sub>	I <sub>cu</sub>	I <sub>cs</sub>	I <sub>cu</sub>	I <sub>cs</sub>	I <sub>cu</sub>	I <sub>cs</sub>	I <sub>cu</sub>	I <sub>cs</sub>	I <sub>cu</sub>	I <sub>cs</sub>	I <sub>cu</sub>	I <sub>cs</sub>	I <sub>cu</sub>	I <sub>cs</sub>	I <sub>cu</sub>	I <sub>cs</sub>
	0.1-0.16	100		100		100		100		100		50		100		100		100		100		100		50	
	0.16-0.25	100		100		100		100		100		50		100		100		100		100		100		50	
	0.25-0.4	100		100		100		100		100		50		100		100		100		100		100		50	
	0.4-0.63	100		100		100		100		100		50		100		100		100		100		100		50	
	0.63-1	100		100		100		100		100		50		100		100		100		100		100		50	
	1-1.6	100		100		100		100		100		50		100		100		100		100		100		50	
	1.6-2.5	100		100		100		100		3	2	50		100		100		100		100		8	6	50	
	2.5-4	100		100		100		100		3	2	50		100		100		100		100		8	6	50	
	4-6.3	100		100		50	38	50	38	3	2	22		100		100		100		100		6	5	50	
	6.3-10	100		100		15	11	10	8	3	2	22		100		100		50	38	50	38	6	5	50	
	9-13	100		50	38	10	8	6	5	3	2	22		100		100		50	38	42	32	6	5	50	
11-16	100		25	19	10	8	6	5	3	2	22		100		50	38	35*	27	10	8	4	3	50		
14-20	50	38	25	19	10	8	6	5	3	2	22		100		50	38	35*	27	10	8	4	3	50		
Vibration resistance		Vibration: 10 to 55 Hz, acceleration: 15 m/s <sup>2</sup>																							
Shock resistance		Shock value 50 m/s <sup>2</sup>																							
Degree of protection		IP20 (IEC60529)																							
Operating temperature		-20°C to +60°C																							
Ambient storage temperature		-40°C to +80°C (no condensation or icing)																							
Relative humidity		95% RH max. (no condensation or icing)																							
Altitude		2000m max.																							
Weight		Approx. 430 g										460 g													
Applicable Standards	Safety Standard	EN 60947-2 (IEC 60947-2), UL60947-4-1, CSA 22.2 No.60947-4-1, CCC GB/T 14048.2, Electrical Appliances and Material Safety Act (Non-Specified Electrical Appliances and Materials)																							

\*JEM1195 breaking duty "O", single time breaking capacity is 50 kA

## Engineering Data

### Operating characteristics curves

J7MC-3P-□ (standard type)/J7MC-3R-□ (high-performance type)

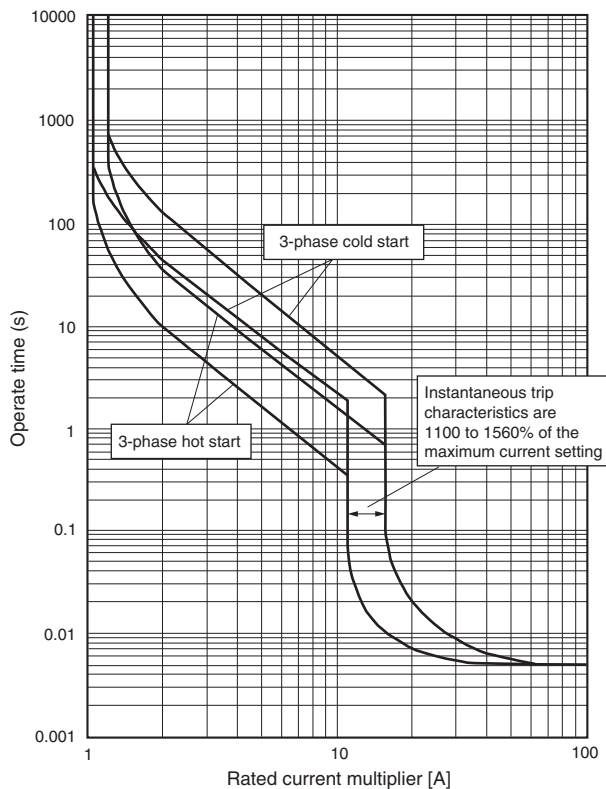

### Average values of operating characteristics (reference values)

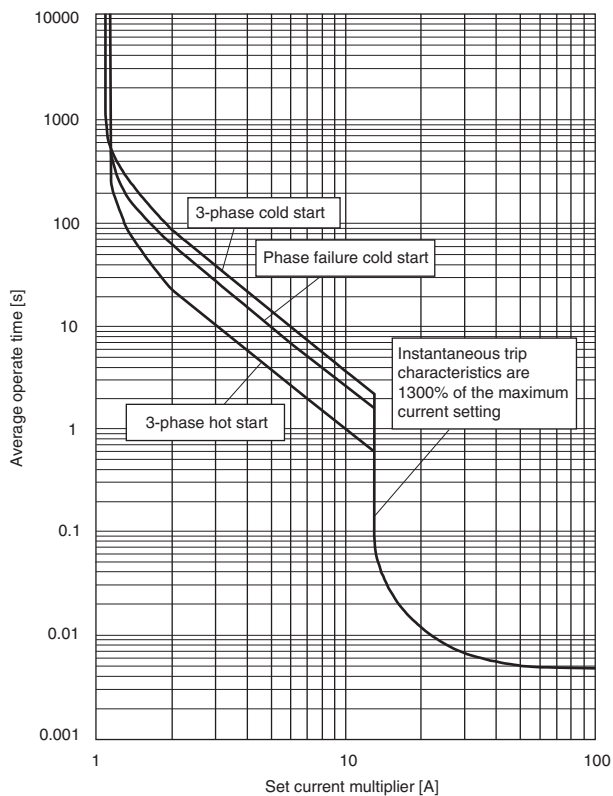

# J7MC Series

## Nomenclature

---

### J7MC-3P-□ (standard type)

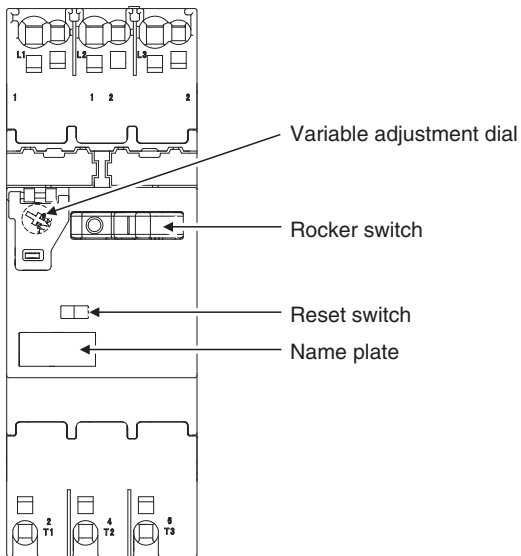

### J7MC-3R-□ (high-performance type)

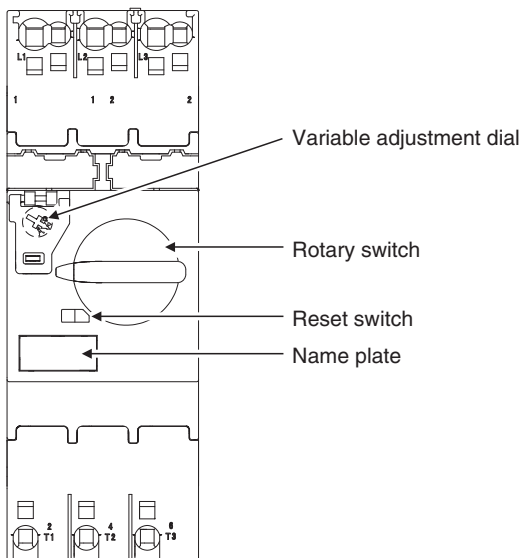

Dimensions

Main unit

J7MC-3P-□ (standard type)

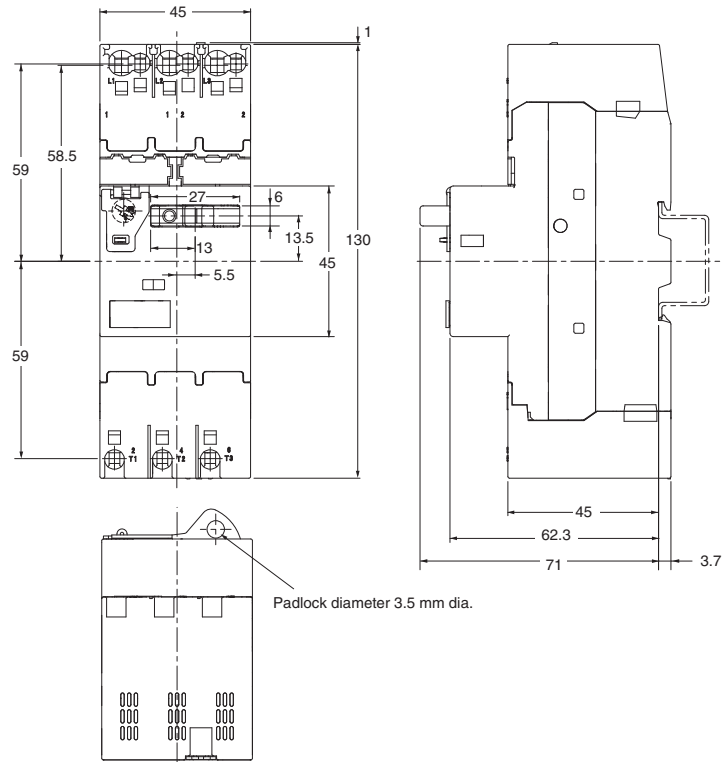

J7MC-3R-□ (high-performance type)

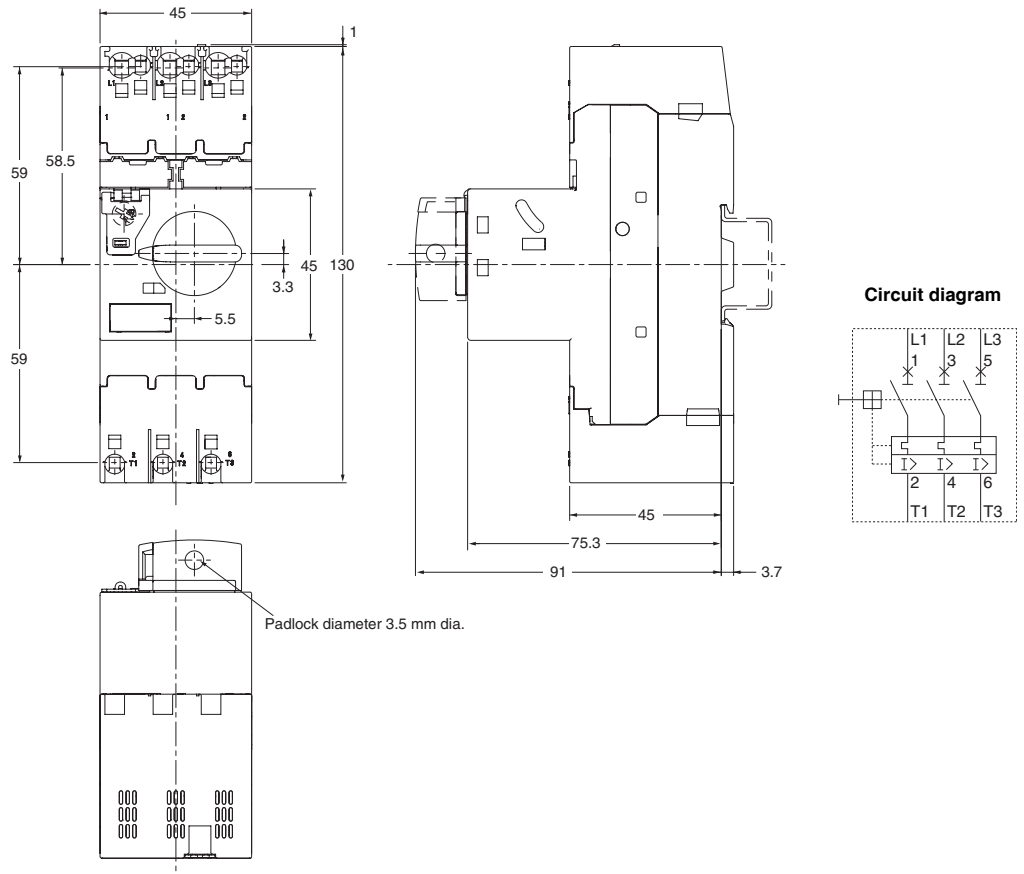

## J7MC Series

### Related Products (Order Separately)

#### Magnetic contactor

##### J7KC

For details, refer to *J7KC Magnetic Contactor Data Sheet* (Catalog No. J230-E1).



#### Short-circuit harmonized protection

Satisfies the harmonized protection types 1 and 2 for magnetic switches and short-circuit protection devices specified in IEC 60947 and JIS C 8201.

- Type 1: Damage to magnetic contactors and thermal overload relays is observed. Requires partial or complete replacement at the time of inspection.
- Type 2: No damage, except slight welding of the contacts in the magnetic contactor. Can remain in use without replacement at the time of inspection.

This greatly reduces the possibility of secondary accidents in the event that an accident occurs.

#### Type 1 rated conditional short-circuit current $I_q = 50$ kA (200 VAC, 400 VAC)

3-phase motor capacity and full load current				Manual motor starter			Short-circuit current $I_q$ [kA]	Magnetic contactor	
200 VAC		400 VAC		Model	Current setting range [A]	Model		Rated operational current AC-3 [A]	
Capacity [kW]	Current [A]	Capacity [kW]	Current [A]						
				J7MC-3P-E16	J7MC-3R-E16	0.1-0.16	50	J7KC-12	12
0.03	0.24	0.06	0.23	J7MC-3P-E25	J7MC-3R-E25	0.16-0.25			
0.06	0.37	0.09	0.32	J7MC-3P-E4	J7MC-3R-E4	0.25-0.4			
		0.12	0.5	J7MC-3P-E63	J7MC-3R-E63	0.4-0.63			
0.1	0.68	0.18	0.65	J7MC-3P-1	J7MC-3R-1	0.63-1.0			
		0.25	0.9	J7MC-3P-1	J7MC-3R-1	0.63-1.0			
0.2	1.3	0.37	1.25	J7MC-3P-1E6	J7MC-3R-1E6	1.0-1.6			
		0.55	1.6	J7MC-3P-2E5	J7MC-3R-2E5	1.6-2.5			
0.4	2.3	0.75	2	J7MC-3P-2E5	J7MC-3R-2E5	1.6-2.5			
		1.1	2.5	J7MC-3P-4	J7MC-3R-4	2.5-4.0			
0.75	3.6	1.5	3.5	J7MC-3P-4	J7MC-3R-4	2.5-4.0			
1.5	6.1	2.2	5	J7MC-3P-6	J7MC-3R-6	4.0-6.3			

**Note:** The 3-phase motor full load current is a reference value. When applying, check the full load current of the motor you will use.

#### Type 2 rated conditional short-circuit current $I_q = 50$ kA (200 VAC, 400 VAC)

3-phase motor capacity and full load current				Manual motor starter			Short-circuit current $I_q$ [kA]	Magnetic contactor	
200 VAC		400 VAC		Model	Current setting range [A]	Model		Rated operational current AC-3 [A]	
Capacity [kW]	Current [A]	Capacity [kW]	Current [A]						
				J7MC-3P-E16	J7MC-3R-E16	0.1-0.16	50	J7KC-12	12
0.03	0.24	0.06	0.23	J7MC-3P-E25	J7MC-3R-E25	0.16-0.25			
0.06	0.37	0.09	0.32	J7MC-3P-E4	J7MC-3R-E4	0.25-0.4			
		0.12	0.5	J7MC-3P-E63	J7MC-3R-E63	0.4-0.63			
0.1	0.68	0.18	0.65	J7MC-3P-1	J7MC-3R-1	0.63-1.0			
		0.25	0.9	J7MC-3P-1	J7MC-3R-1	0.63-1.0			
0.2	1.3	0.37	1.25	J7MC-3P-1E6	J7MC-3R-1E6	1.0-1.6			
		0.55	1.6	J7MC-3P-2E5	J7MC-3R-2E5	1.6-2.5			
0.4	2.3	0.75	2	J7MC-3P-2E5	J7MC-3R-2E5	1.6-2.5			
		1.1	2.5	J7MC-3P-4	J7MC-3R-4	2.5-4.0			
0.75	3.6	1.5	3.5	J7MC-3P-4	J7MC-3R-4	2.5-4.0			

**Note:** The 3-phase motor full load current is a reference value. When applying, check the full load current of the motor you will use.



**Rated combination table and SCCR for North America**

220-240 V		440-480 V		Manual motor starter			Magnetic contactor	Short-circuit current rating SCCR [kA]
Rated capacity [Hp]	Rated operational current [A]	Rated capacity [Hp]	Rated operational current [A]	Model		Current setting range [A]	Model	
*	0.16	*	0.16	J7MC-3P-E16	J7MC-3R-E16	0.1-0.16	J7KC-12	65 kA
	0.25		0.25	J7MC-3P-E25	J7MC-3R-E25	0.16-0.25		65 kA
	0.4		0.4	J7MC-3P-E4	J7MC-3R-E4	0.25-0.4		65 kA
	0.63		0.63	J7MC-3P-E63	J7MC-3R-E63	0.4-0.63		65 kA
	1		1	J7MC-3P-1	J7MC-3R-1	0.63-1.0		65 kA
	1.6		3/4	1.6	J7MC-3P-1E6	J7MC-3R-1E6		1.0-1.6
1/2	2.2	1	2.1	J7MC-3P-2E5	J7MC-3R-2E5	1.6-2.5		65 kA
3/4	3.2	2	3.4	J7MC-3P-4	J7MC-3R-4	2.5-4		65 kA
1-1/2	6	3	4.8	J7MC-3P-6	J7MC-3R-6	4-6.3		65 kA
		5	7.6	J7MC-3P-10	J7MC-3R-10	6.3-10		25 kA
3	9.6			J7MC-3P-10	J7MC-3R-10	6.3-10		25 kA
		7-1/2	11	J7MC-3P-13	J7MC-3R-13	9-13		10 kA

\* An area where horsepower is not defined in UL60947-4-1 (SCCR is acquired in this area)

## Accessories (Order Separately)

### Auxiliary contact unit J73MC-W-□

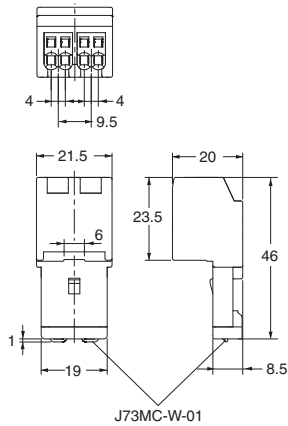

A unit in which the contacts operate in synchronization with the ON/OFF operation of the main unit.  
Up to two auxiliary contact units can be mounted on the left and right front panels.

#### Circuit diagram

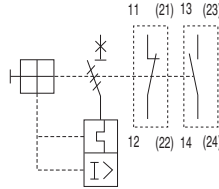

- Note:**
1. The terminal numbers ( ) in the circuit diagram are the terminal numbers when mounting on the right front panel.
  2. Refer to page 17 for the combinations of accessories that can be mounted simultaneously.

### Alarm contact unit J73MC-K-□

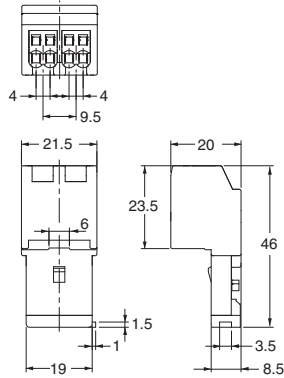

The contacts in this unit operate when the main unit trips due to an overload, phase failure, or short circuit.  
(The contacts are not synchronized with ON/OFF operation of the main unit)

#### Circuit diagram

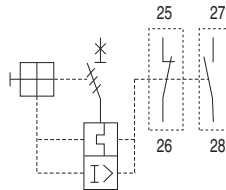

- Note:**
1. Operation can be checked with a test trip.
  2. Refer to page 17 for the combinations of accessories that can be mounted simultaneously.

Model	J73MC-W-□		J73MC-K-□		
Compliant standards	IEC 60947-5-1, UL 508				
Auxiliary contact	SPST-1NO (1a), SPST-1NC (1b)				
Rated carry current [A]	IEC 60947-5-1		6		
	UL 508		5		
Rated operating current [A]	IEC 60947-5-1	AC-15	48 V	5	
			125 V	3	
			230 V	1.5	
		DC-13	48 V	1.38	
			110 V	0.55	
			220 V	0.27	
	UL 508	AC	B300	120 V	3
				240 V	1.5
DC		Q300	125 V	0.55	
			250 V	0.27	
Mechanical life expectancy [cycles]	100,000		1,000		
Minimum operating voltage/current	17 VDC, 5 mA				
Contact form	Double-break				
Contact material	Ag alloy				

**Insulation stop  
J77MC-A**

Guide for insertion into terminal (insertion) holes to stabilize holding of 1mm<sup>2</sup> or less stranded wire (direct insertion).

**For MMS main unit (set for power supply side and load side)**

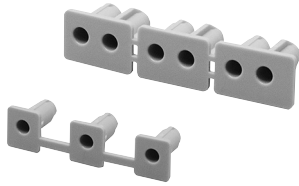

(Power supply side)

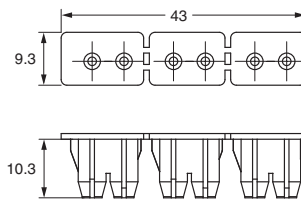

(Load side)

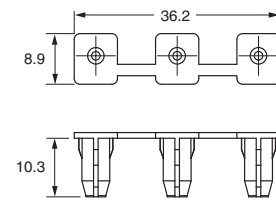

**J77MC-B**

**For auxiliary contacts and alarm contacts**

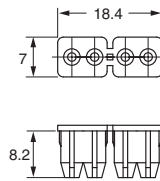

**DIN Rails (Order Separately)**

(Unit: mm)

**Mounting Rail  
PFP-100N  
PFP-50N**

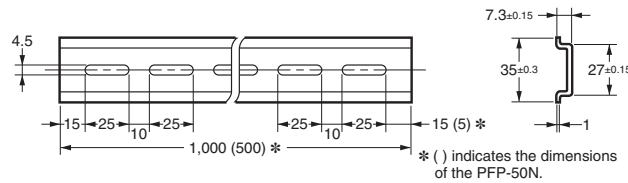
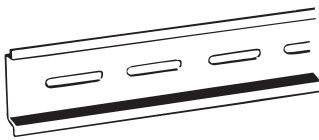

Model
PFP-100N
PFP-50N

**Mounting Rail  
PFP-100N2**

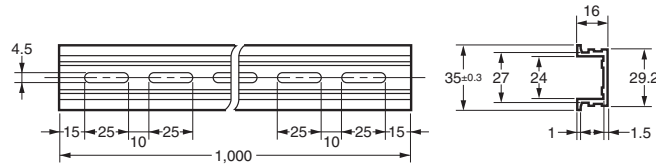
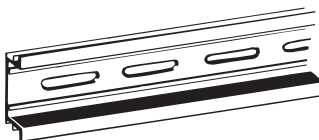

Model
PFP-100N2

**End Plate  
PFP-M**

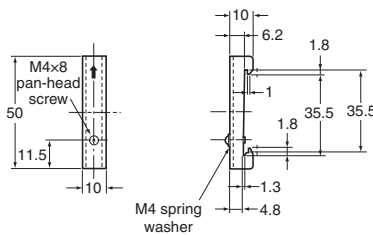
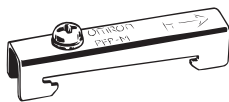

Model
PFP-M

**Spacer  
PFP-S**

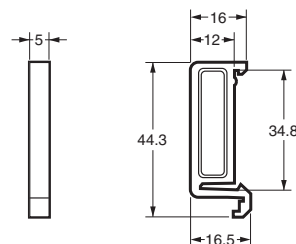
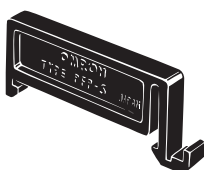

Model
PFP-S





**Note:** 1. Order the parts above in units of ten. The prices shown above are standard prices for one piece.  
2. Rails conform to DIN standards.

## Safety Precautions

### Warning Indications

 <b>CAUTION</b>	Indicates a potentially hazardous situation which, if not avoided, is likely to result in minor or moderate injury or property damage.
<b>Precautions for Safe Use</b>	Supplementary comments on what to do or avoid doing, to use the product safely.
<b>Precautions for Correct Use</b>	Supplementary comments on what to do or avoid doing to prevent failure to operate, malfunction, or undesirable effects on product performance.

### Meaning of Product Safety Symbols

	Used to warn of the risk of electric shock under specific conditions.
	Used to indicate prohibition when there is a risk of minor injury from electric shock or other source if the product is disassembled.
	Used for general prohibitions for which there is no specific symbol.
	Used for general mandatory action precautions for which there is no specified symbol.

### CAUTION

Do not touch or approach the product while or immediately after power is supplied. Electric shock or burn injuries may occur.



Never disassemble, modify, or repair the product or touch any of the internal parts. Minor electric shock, fire, or malfunction may occasionally occur.



Do not use the product in an environment where flammable or explosive gas is present.



Relay life expectancy varies considerably with output load and switching conditions. Always consider the application conditions and use within the rated load and electrical life expectancy.



### Precautions for Safe Use

- Do not use the product in any of the following locations.
  - Places subject to intense temperature changes
  - Places subject to high humidity or condensation
  - Places subject to intense vibration or shock
  - Places subject to considerable dust or corrosive gas, or directly exposed to sunlight
  - Places subject to splashing water, oil, or chemicals.
- Do not store or use in conditions that subject the product to an external load.
- Securely mount the product on the rail.
- When mounting on a support rail, use the end plate.
- Never drop the product or allow it to fall.
- If the product automatically breaks the circuit, remove the cause and then switch on the rocker switch or rotary switch.
- When installing the product, ensure that the required clearance around the product is maintained.
- Make sure that foreign matter does not collect or enter into the terminal (insertion) hole or release hole. Smoking or ignition, malfunctioning, or failure may occur.
- Do not use the product at less than the minimum applicable load.
- Never use at a load that exceeds the rated capacity.
- Use wire, ferrules, and tools with the required specifications. Strip the wires to the specified length, and use ferrules of the specified length. Insert all the way into the terminal (insertion) hole until the wire tip contacts the back.  
(For details, refer to the information on pages 14 and 15.)
- If directly inserting wire, always use tin-plated strand wire.
- Do not insert multiple wires into one terminal (insertion) hole.
- Do not wire terminals that are not used.
- Make sure all wiring connections are correct before supplying power.
- Do not accidentally insert a wire into the release hole.
- Do not bend a wire past its natural bending radius or pull on it with excessive force.
- After inserting the tool into the release hole, do not pry with the tool.
- Do not insert the tool into the terminal (insertion) hole.
- Do not supply power while the tool is inserted into the release hole.
- Do not insert anything other than the specified tool into the release hole.
- Wipe off any dirt from the product with a soft dry cloth. Never use thinners, benzine, alcohol, or any cleaners that contain these or other organic solvents. Deformation or discoloration may occur.
- When disposing of the product, follow local disposal procedures for industrial waste.

### Precautions for Correct Use

- Avoid use in a location with many magnetic particles. Risk of failure.
- Be sure to follow the steps in the Datasheet and carry out the procedure properly when attaching the optional units to the main Unit.

# Handling during mounting, removal, wiring (connection), and settings

## Mounting and removal method

### Mounting on rail

(Power supply side)

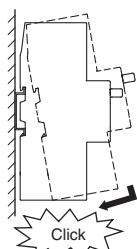

(Load side)

### Removal from rail

(Power supply side)

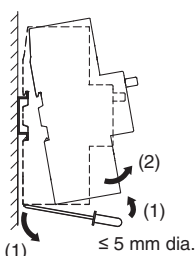

(Load side)

### <Mounting>

Hook onto the hook on the power side of the support rail, and press in the direction of the arrow until you hear a "click" sound.

### <Removal>

Insert a flat blade screwdriver into the hook on the load side, and pull down to remove.

- When mounting on a support rail, use the end plate (PFP-M).
- Fix the main unit to the rail with a screw spacing within 400 mm.
- Use a mounting plate with a thickness and shape that resists deflection. Excessive vibration may cause false tripping.

## Mounting angle

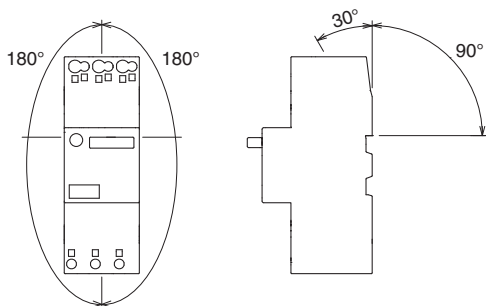

## Arc space and mounting interval

When mounting the unit, ensure that the following arc space is available.

J7MC-3P-□		(mm)		
Rated operational voltage	A, B	C, D	E	
Up to 500 V	15	10	0 *	
Up to 690 V	40	30	0 *	

J7MC-3R-□		(mm)		
Rated operational voltage	A, B	C, D	E	
Up to 500 V	15	20	0 *	
Up to 690 V	40	40	0 *	

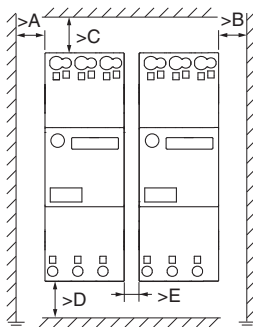

\* When units are closely mounted together, the thermal characteristics may change because of temperature increases due to the operating conditions (high ambient temperature or maximum set continuous carry current).  
If the unit operates unnecessarily, slightly increase the thermal setting.

## Current Setting

Depending on whether the units are individually mounted or closely mounted, adjust arrow A or arrow B to the motor rated current value on the variable adjustment dial, as shown in the diagrams below. Turn the adjustment dial and make the setting within the scale range. Full performance may not be achieved if used outside the scale range.

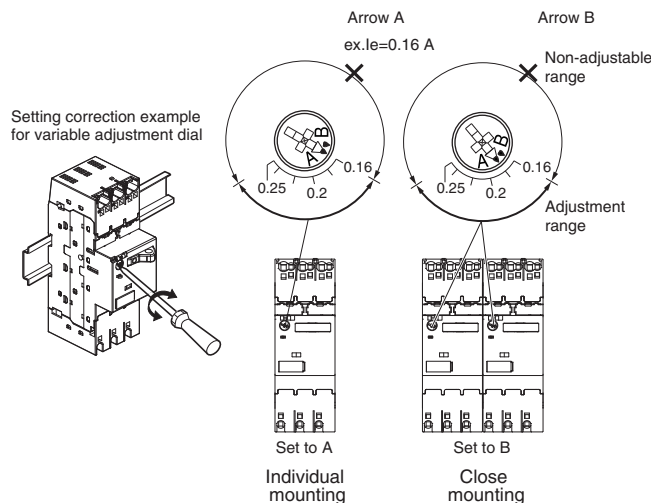

In addition, when selecting a setting near the border of the rated operating current setting range, you are recommended to select a main unit with a minimum setting that provides an adjustment margin for unnecessary operation.

Example) 0.63-1A and 1-1.6A product are available for a 1 A load.  
Select the 1-1.6A product.

## Wiring

### Wire with ferrule

- (1) Insert straight in until the ferrule contacts the terminal block.
- (2) After inserting, pull the wire lightly and check the connection.

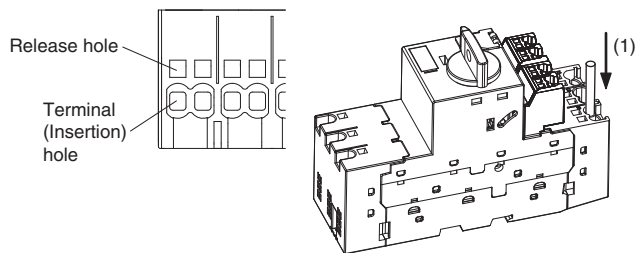

## Stranded wire (direct insertion)

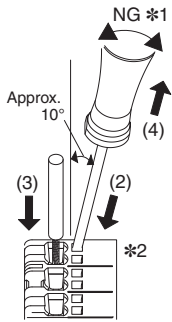

- (1) Before inserting, twist the core wire of the electric wire.
- (2) Insert the recommended tool straight at about 10° angle in the direction of the arrow, into the terminal block until the end touches the release hole.
- (3) With the tool inserted in the release hole, insert straight in until the wire contacts the terminal block.
- (4) Remove the tool from the release hole.
- (5) After inserting, pull the wire lightly and check the connection.

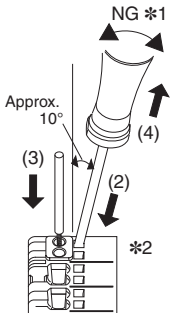

- \* When using an insulation stop  
After inserting the insulation stop into the terminal (insertion) hole all the way to the base, perform steps (1) to (5). The insulation stop will insert easily if you insert at a slight angle to the terminal (insertion) hole and twist as you press it in.
- \*1. Do not prying by the tool.

## Removing wire

### Common for electric wires with ferrules and stranded wires (direct insertion)

- (1) Insert the recommended tool straight at about 10° angle in the direction of the arrow, into the terminal block until the end touches the release hole.
- (2) With the tool still inserted into the release hole, remove the wire from the terminal insertion hole.
- (3) Remove the tool from the release hole.

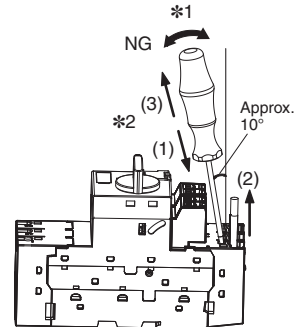

- \*1. Do not prying by the tool.  
\*2. The inside of the release hole is electrically live. Electric shock may result. Do not use a screwdriver with a metal handle. Do not touch the metal part of the tool.

## Connection method and application size of the electric wire

- If directly inserting wire, always use tin-plated strand wire.
- Crimp the ferrule for stranded wires that are not tin plated.
- Solid wire and bar terminals cannot be used.

### Wire size

Applicable wire		Ferrules used							Stranded wire (direct insertion) *3		
(mm <sup>2</sup> )	(AWG)	Size (mm <sup>2</sup> )	With an insulation sleeve			Without an insulation sleeve			Main circuit (1)	Main circuit (2)(3)	Auxiliary circuit
			Main circuit (1) (L=12 mm)	Main circuit (2)(3) (L=12 mm)	Auxiliary circuit (L=8 mm)	Main circuit (1) (L=12 mm)	Main circuit (2)(3) (L=12 mm)	Auxiliary circuit (L=10 mm)			
0.5	20	0.5	---	---	⊙	---	---	---	---	---	⊙ (*2)
0.75	18	0.75	○	○	⊙	---	---	---	○ (*2)	○ (*2)	⊙ (*2)
1		1	○	○	⊙	---	---	---	○ (*2)	○ (*2)	⊙ (*2)
1.25	16	1.5	○	○	⊙	---	---	---	○	○	⊙
1.5			○	○	⊙	---	---	---	○	○	⊙
2	14	2 (*1)	○	○	⊙	---	---	---	○	○	⊙
2.5		2.5	○	○	---	---	---	---	○	○	---
4	12	4	○	---	---	---	○	---	---	---	
6	10	6	---	---	---	○	---	---	---	---	

⊙: 2 wires allowed (simultaneous connection for crossover wiring terminals), ○: 1 wire allowed, -: out of specification

\*1. Connection is only possible using 2 mm<sup>2</sup> FE-2.08-8N-YE ferrules with insulation sleeves manufactured by Wago.

\*2. Use insulation stops. Insulation stops cannot be used with ferrules.

Do not use an insulation stop in empty terminals.

\*3. Insulation stripping length for stranded wires (direct insertion) is as follows.

Main circuit (1)(2)(3): 15±1 mm

Auxiliary circuit: 11±1 mm

When using ferrules, refer to the table of recommended ferrules.

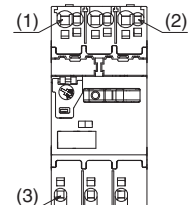

## Recommended Ferrules and Crimp Tools

### Recommended ferrules

Applicable wire		Ferrules used Conductor length (mm)	Recommended ferrules							
			With an insulation sleeve				Without an insulation sleeve			
(mm <sup>2</sup> )	(AWG)	Insulation stripping length (mm)	Phoenix Contact	Weid muller	Wago	Insulation stripping length (mm)	Phoenix Contact	Weid muller	Wago	
0.5	20		8	10	Al 0,5-8		H0.5/14 H0.5/14S	FE-0.5-8N-WH	---	---
0.75	18	8	10	Al 0,75-8	H0.75/14 H0.75/14S	FE-0.75-8N-GY	---	---	---	---
		12	14	Al 0,75-12	H0.75/18 H0.75/18D H0.75/18T	FE-0.75-12N-GY	---	---	---	---
1	18	8	10	Al 1-8	H1.0/14 H1.0/14S	FE-1.0-8N-RD	---	---	---	---
		12	14	Al 1-12	H1.0/18 H1.0/18D	FE-1.0-12N-RD	---	---	---	---
1.25/ 1.5	16	8	10	Al 1,5-8	H1.5/14 H1.5/14S	FE-1.5-8N-BK	---	---	---	---
		12	14	Al 1,5-12	H1.5/18D	FE-1.5-12N-BK	---	---	---	---
2	14	8	10	---	---	FE-2.08-8N-YE	---	---	---	---
2/2.5	14	12	14	Al 2,5-12	H2.5/19D H2.5/19T	FE-2.5-12N-BU	---	---	---	---
3.5/4	12	12	14	Al4-12	H4.0/20D H4.0/20T	FE-4.0-12N-GY	12	A4-12	H4,0-12	F-4.0-12
6	10	12	---	---	---	---	12	A6-12	H6,0-12	F-6.0-12
Recommended crimp tool				CRIMPFOX 6 CRIMPFOX 6T-F CRIMPFOX 10S	PZ6 roto	Variocrimp4		CRIMPFOX 6 CRIMPFOX 6T-F CRIMPFOX 10S	PZ6 roto	Variocrimp4

\* Make sure that the outer diameter of the wire coating is smaller than the inner diameter of the insulation sleeve of the recommended ferrule.

### Ferrule processing dimensions

Dimensions		Main circuit		Auxiliary circuit	
		Minimum	Maximum	Minimum	Maximum
L [mm]		0	0.5	0	0.5
D [mm]		0.9	3.2	0.8	2.6
Wire size	[mm <sup>2</sup> ]	0.75	2.5/4	0.5	2
	[AWG]	18	14/12	20	14

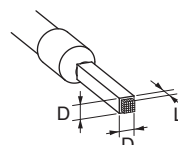

### Recommended Flat-blade Screwdriver (Recommended tool)

Use a flat-blade screwdriver to connect and remove wires.

Use the flat-blade screwdriver shown in the table below.

The following table shows manufacturers and models as of 2018/Dec.

#### Main circuit

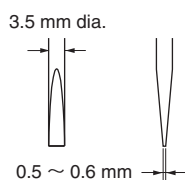

Model	Manufacturer
SZF 1-0,6x3,5	Phoenix Contact
0.6x3.5x100 302	Wiha
AEF.3,5x75	Facom
210-720	Wago
SDS 0.6x3.5x100	Weidmuller

#### Auxiliary circuit

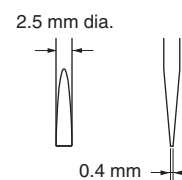

Model	Manufacturer
ESD 0,40x2,5	Wera
SZS 0,4x2,5 SZF 0-0,4x2,5 *	Phoenix Contact
0.4x2.5x75 302	Wiha
AEF.2,5x75	Facom
210-719	Wago
SDIS 0.4x2.5x75	Weidmuller
9900 (-2.5x75)	Vessel

\* OMRON's exclusive purchase model XW4Z-00B is available to order as SZF 0-0,4x2,5 (manufactured by Phoenix Contact).

## Test trip and switch lock

### Test trip

During a sequence check, you can perform a mechanical test trip. Operate as shown below.

#### J7MC-3P-□

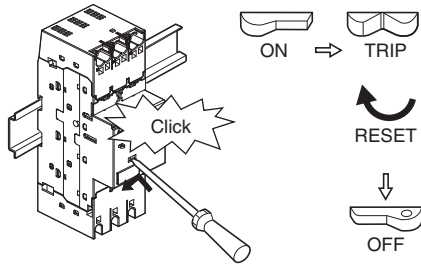

#### J7MC-3R-□

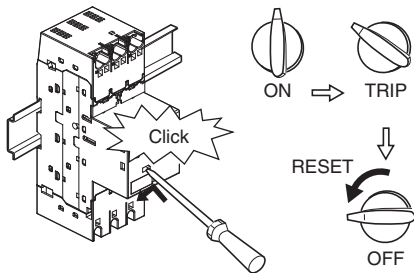

### Switch lock

This function is used to put a padlock on the handle and lock the unit in the OFF state.

For the padlock, use a commercially available 3.5 mm dia. padlock.

#### J7MC-3P-□

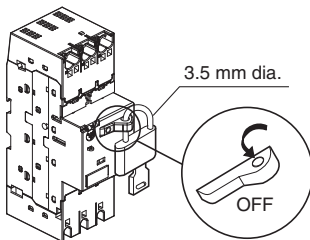

#### J7MC-3R-□

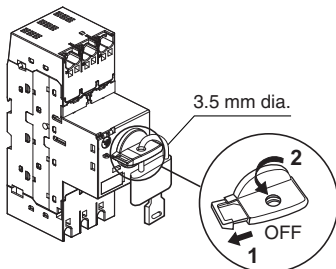

## Mounting optional unit

1. Turn OFF the unit.
2. Remove the cover with the recommended tool or other tool. Once the cover has been removed, it cannot be reattached.
3. Insert the accessory into the part from which you removed the cover until you hear a click sound.

#### J7MC-3P-□

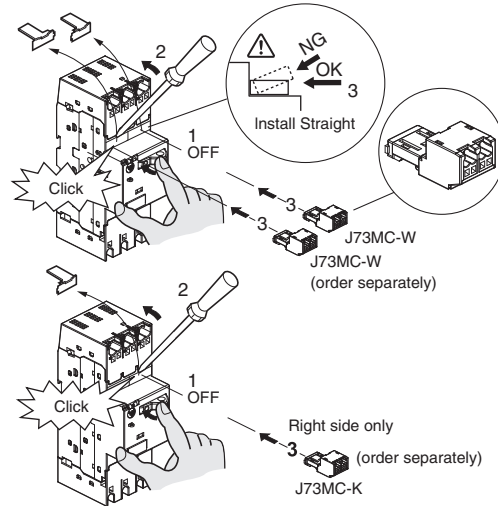

#### J7MC-3R-□

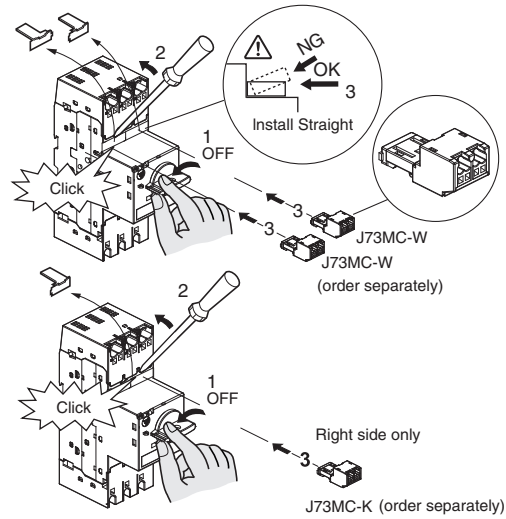

## Removing optional unit

Turn the unit OFF, insert a flat-blade screwdriver (3 mm or dia. or more) into the slot in the accessory as shown, and push the optional unit upwards to remove it.

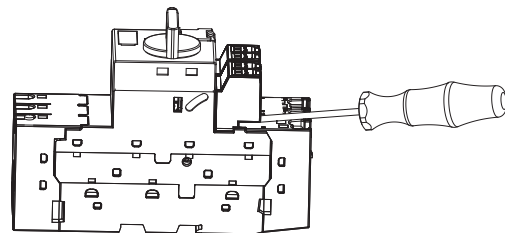



## Table of accessory combinations

### Mounting position of accessories

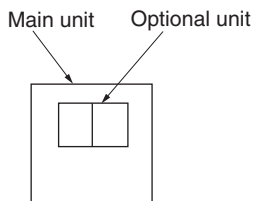

Optional units

- Auxiliary contact unit (W) : J73MC-W
- Alarm contact unit (K) : J73MC-K

Main unit model	J73MC-3P/J7MC-3R					
Optional unit combination	---	W (left)	W (right)	K (right)	W + W	W + K

## MMS main unit operation and optional auxiliary contact operation

indicates the optional unit contacts ON (closed) state.

### Optional units

Type	Contacts	Marked number *2		Terminal number (nominal) *2		MMS main unit status					
				Mark for left mounting (1-)	Mark for right mounting (2-)	OFF	ON	Trip	Reset		
Auxiliary contact W	SPST-NO	-3	-4	13	14	23	24				
	SPST-NC	-1	-2	11	12	21	22				
Alarm contact K *1	SPST-NO	-7	-8			27	28				
	SPST-NC	-5	-6			25	26				

\*1. The alarm contacts operate when the MMS main unit trips due to an overload, phase failure, or short circuit. Resetting the MMS main unit returns the alarm contacts to the initial state.

\*2. Reading the optional unit terminal number

The terminal number of Terminals A is called "13" because the first digit of the terminal number is "1" as it is mounted on the left side of the main unit, and the second digit of the terminal number is "3" because the optional unit is the left terminal.

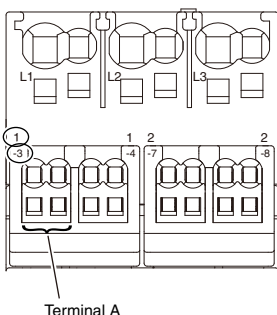

### Electrical detection

Electricity can be detected by inserting a detector in the release hole.

When inserting a detector, insert it gently while checking for electrical signals. The wire may pull out if the detector is fully inserted.

After detection is complete, immediately pull out the detector and check that the wire is still firmly connected.

### Recommended replacement period

Magnetic contactors and switches have a wear life according to the number of switching cycles of their main contacts and mechanical parts. The coil wiring and electronic parts in the electronic unit have a service life resulting from deterioration due to the operating environment and conditions.

You are recommended to replace magnetic contactors and switches after the rated number of switching cycles specified in the catalog, or 10 years after the date of manufacture according to the standard conditions of operation described in the "Survey on Low-voltage Equipment Update Recommendation Times" report prepared by the Japan Electrical Manufacturers' Association (JEMA).

**OMRON AUTOMATION AMERICAS HEADQUARTERS** • Chicago, IL USA • 847.843.7900 • 800.556.6766 • automation.omron.com

**OMRON CANADA, INC. • HEAD OFFICE**

Toronto, ON, Canada • 416.286.6465 • 866.986.6766 • automation.omron.com

**OMRON ELECTRONICS DE MEXICO • HEAD OFFICE**

Ciudad de México • 52.55.5901.4300 • 01.800.386.6766 • mela@omron.com

**OMRON ELECTRONICS DE MEXICO • SALES OFFICE**

San Pedro Garza García, N.L. • 81.12.53.7392 • 01.800.386.6766 • mela@omron.com

**OMRON ELECTRONICS DE MEXICO • SALES OFFICE**

Eugenio Garza Sada, León, Gto • 01.800.386.6766 • mela@omron.com

**OMRON ELETRÔNICA DO BRASIL LTDA • HEAD OFFICE**

São Paulo, SP, Brasil • 55.11.2101.6300 • www.omron.com.br

**OMRON ARGENTINA • SALES OFFICE**

Buenos Aires, Argentina • +54.11.4521.8630 • +54.11.4523.8483  
mela@omron.com

**OTHER OMRON LATIN AMERICA SALES**

+54.11.4521.8630 • +54.11.4523.8483 • mela@omron.com

*Authorized Distributor:*

**Controllers & I/O**

- Machine Automation Controllers (MAC) • Motion Controllers
- Programmable Logic Controllers (PLC) • Temperature Controllers • Remote I/O

**Robotics**

- Industrial Robots • Mobile Robots

**Operator Interfaces**

- Human Machine Interface (HMI)

**Motion & Drives**

- Machine Automation Controllers (MAC) • Motion Controllers • Servo Systems
- Frequency Inverters

**Vision, Measurement & Identification**

- Vision Sensors & Systems • Measurement Sensors • Auto Identification Systems

**Sensing**

- Photoelectric Sensors • Fiber-Optic Sensors • Proximity Sensors
- Rotary Encoders • Ultrasonic Sensors

**Safety**

- Safety Light Curtains • Safety Laser Scanners • Programmable Safety Systems
- Safety Mats and Edges • Safety Door Switches • Emergency Stop Devices
- Safety Switches & Operator Controls • Safety Monitoring/Force-guided Relays

**Control Components**

- Power Supplies • Timers • Counters • Programmable Relays
- Digital Panel Meters • Monitoring Products

**Switches & Relays**

- Limit Switches • Pushbutton Switches • Electromechanical Relays
- Solid State Relays

**Software**

- Programming & Configuration • Runtime