

PJ78L05SA

3-Terminal Voltage Regulator

Features

- Input voltage: up to 30V
- Output: 5V
- Output current up to 100 mA, internal thermal overload protection and short-circuit current limiting.

SOT-23

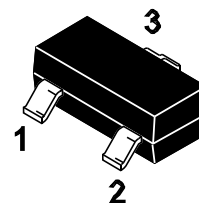

1. OUT 2. IN 3. GND

Marking Code : P805

Absolute Maximum Ratings

Ratings at 25°C ambient temperature unless otherwise specified.

Parameter	Symbol	Value	Unit
Input Voltage	V_I	30	V
Output Current	I_O	100	mA
Junction Temperature	T_J	150	°C
Operating Temperature Range	T_{OPR}	-40 to +125	°C
Storage Temperature Range	T_{STG}	-55 to +150	°C

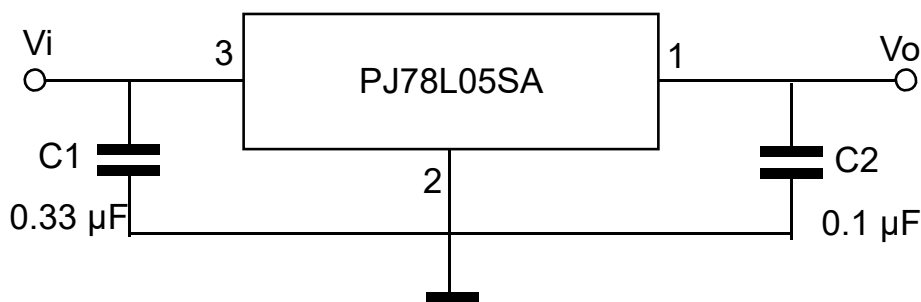



PJ78L05SA

3-Terminal Voltage Regulator

Electrical Characteristics

Ratings at 25°C ambient temperature unless otherwise specified.

Parameter	Symbol	Test Conditions	Min.	Typ.	Max.	Unit
Output Voltage	V_o	$I_o=40\text{mA}, T_J=25^\circ\text{C}$	4.80	5.0	5.2	V
		$I_o=1\text{mA to }40\text{mA}, V_i=7\text{V to }20\text{V}$	4.75	5.0	5.25	V
		$I_o=1\text{mA to }70\text{mA}, V_i=10\text{V}$	4.75	5.0	5.25	V
Line Regulation	ΔV_o	$V_i=7\text{V to }20\text{V}, T_J=25^\circ\text{C}$	--	32	150	mV
		$V_i=8\text{V to }20\text{V}, T_J=25^\circ\text{C}$	--	26	100	mV
Load Regulation	ΔV_o	$I_o=1\text{mA to }100\text{mA}, T_J=25^\circ\text{C}$	--	15	60	mV
		$I_o=1\text{mA to }40\text{mA}, T_J=25^\circ\text{C}$	--	8	30	mV
Ripple Rejection	RR	$V_i=8\text{V to }18\text{V}, f=120\text{Hz}, T_J=25^\circ\text{C}$	41	49	--	dB
Dropout Voltage	V_D	$T_J=25^\circ\text{C}$	--	1.7	--	V
Quiescent Current	I_q	$T_J=25^\circ\text{C}$	--	3.8	6	mA
		$T_J=125^\circ\text{C}$	--	--	5.5	mA
Quiescent Current Change	ΔI_q	$V_i=8\text{V to }20\text{V}$	--	--	1.5	mA
		$I_o=1\text{mA to }40\text{mA}$	--	--	0.1	mA
Output Noise Voltage	V_N	$10\text{Hz} \leq f \leq 100\text{KHz}, T_J=25^\circ\text{C}$	--	42	--	μV



Typical Characteristic Curves

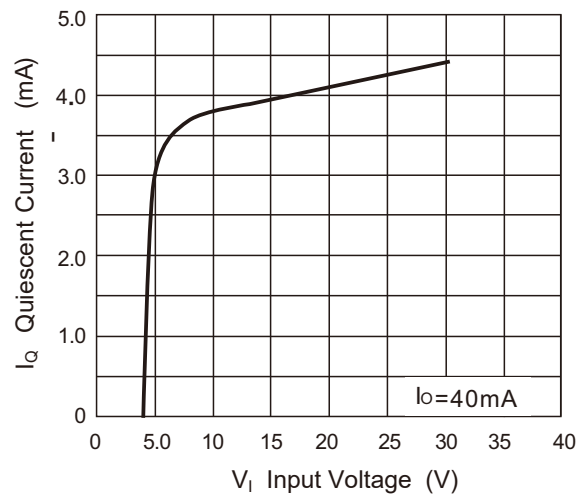
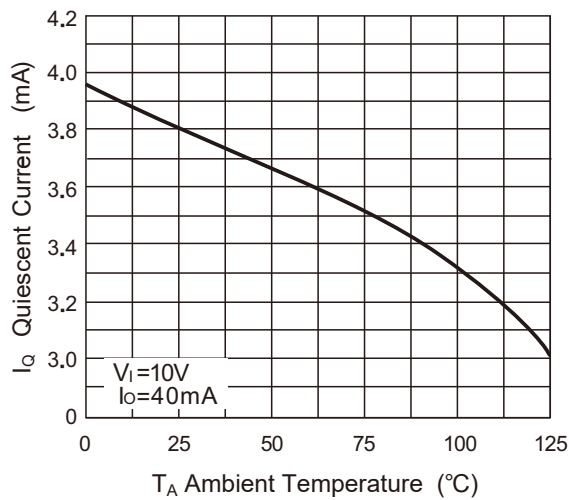
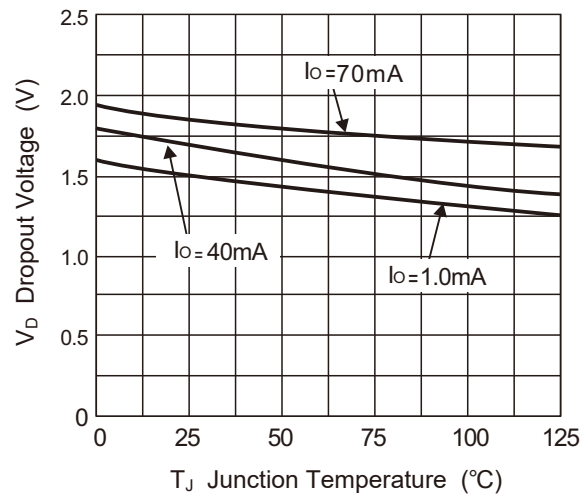
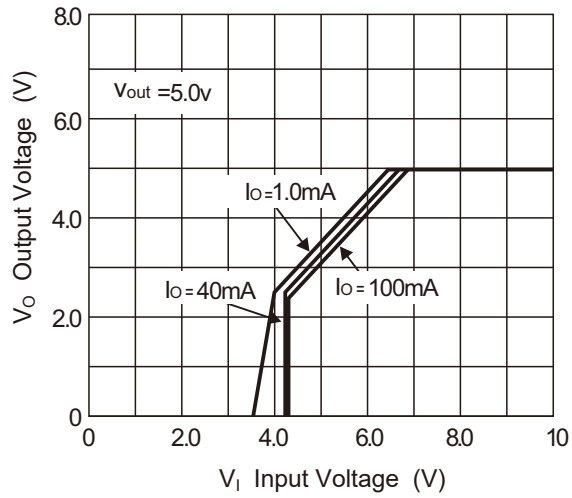

Package Outline

SOT-23

Dimensions in mm

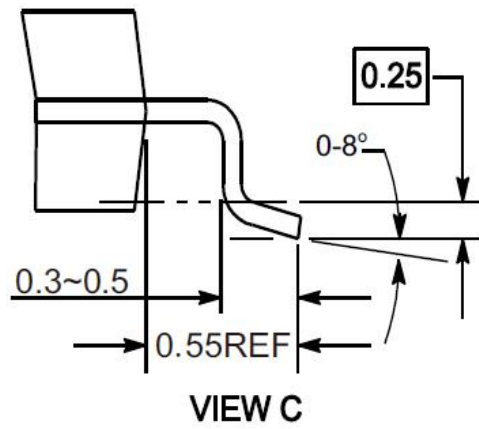
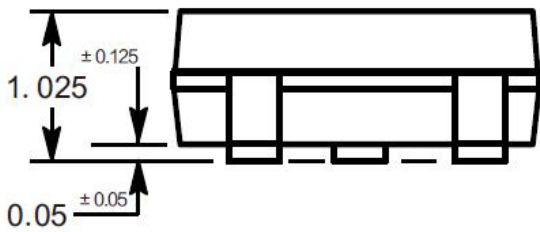
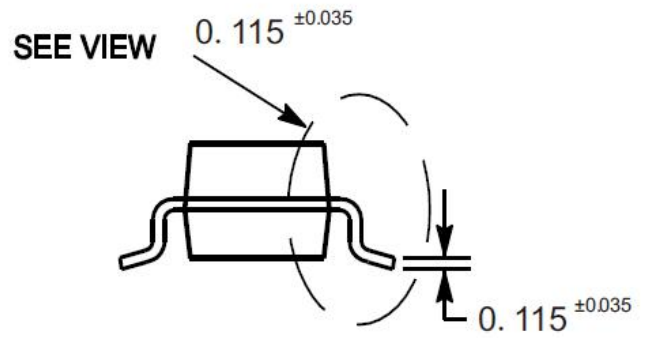
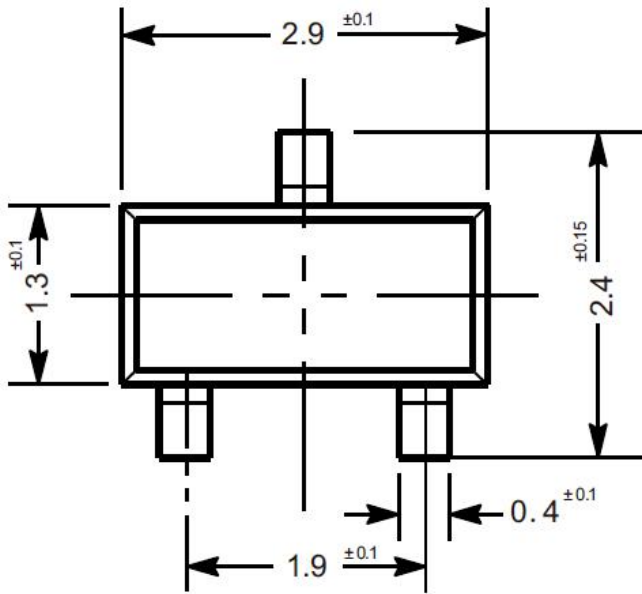

Ordering Information

Device	Package	Shipping
PJ78L05SA	SOT-23	3,000PCS/Reel&7inches