

NCP2892 Series

1.3 Watt Audio Power Amplifier with Fast Turn On Time

The NCP2892 is an audio power amplifier designed for portable communication device applications such as mobile phone applications. The NCP2892 is capable of delivering 1.3 W of continuous average power to an 8.0 Ω BTL load from a 5.0 V power supply, and 1.0 W to a 4.0 Ω BTL load from a 3.6 V power supply.

The NCP2892 provides high quality audio while requiring few external components and minimal power consumption. It features a low-power consumption shutdown mode, which is achieved by driving the SHUTDOWN pin with logic low.

The NCP2892 contains circuitry to prevent from “pop and click” noise that would otherwise occur during turn-on and turn-off transitions.

For maximum flexibility, the NCP2892 provides an externally controlled gain (with resistors), as well as an externally controlled turn-on time (with the bypass capacitor). When using a 1 μ F bypass capacitor, it offers 100 ms wake up time.

Due to its excellent PSRR, it can be directly connected to the battery, saving the use of an LDO.

This device is available in a 9-Pin Flip-Chip CSP (Lead-Free).

Features

- 1.3 W to an 8.0 Ω BTL Load from a 5.0 V Power Supply
- Excellent PSRR: Direct Connection to the Battery
- “Pop and Click” Noise Protection Circuit
- Ultra Low Current Shutdown Mode: 10 nA
- 2.2 V–5.5 V Operation
- External Gain Configuration Capability
- External Turn-on Time Configuration Capability: 100 ms (1 μ F Bypass Capacitor)
- Up to 1.0 nF Capacitive Load Driving Capability
- Thermal Overload Protection Circuitry
- This is a Pb-Free Device*

Typical Applications

- Portable Electronic Devices
- PDAs
- Wireless Phones

*For additional information on our Pb-Free strategy and soldering details, please download the ON Semiconductor Soldering and Mounting Techniques Reference Manual, SOLDERRM/D.



ON Semiconductor®

<http://onsemi.com>

MARKING DIAGRAMS



9-Pin Flip-Chip CSP
FC SUFFIX
CASE 499E



MAx = Specific Device Code
X = NCP2892A
Z = NCP2892B
A = Assembly Location
Y = Year
WW = Work Week
▪ = Pb-Free Package

PIN CONNECTIONS

9-Pin Flip-Chip CSP

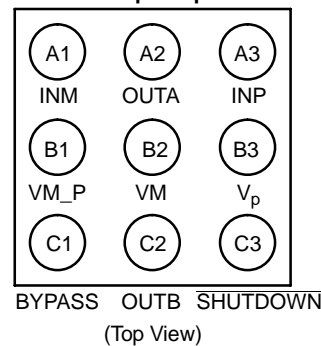

ORDERING INFORMATION

See detailed ordering and shipping information in the package dimensions section on page 15 of this data sheet.

NCP2892 Series

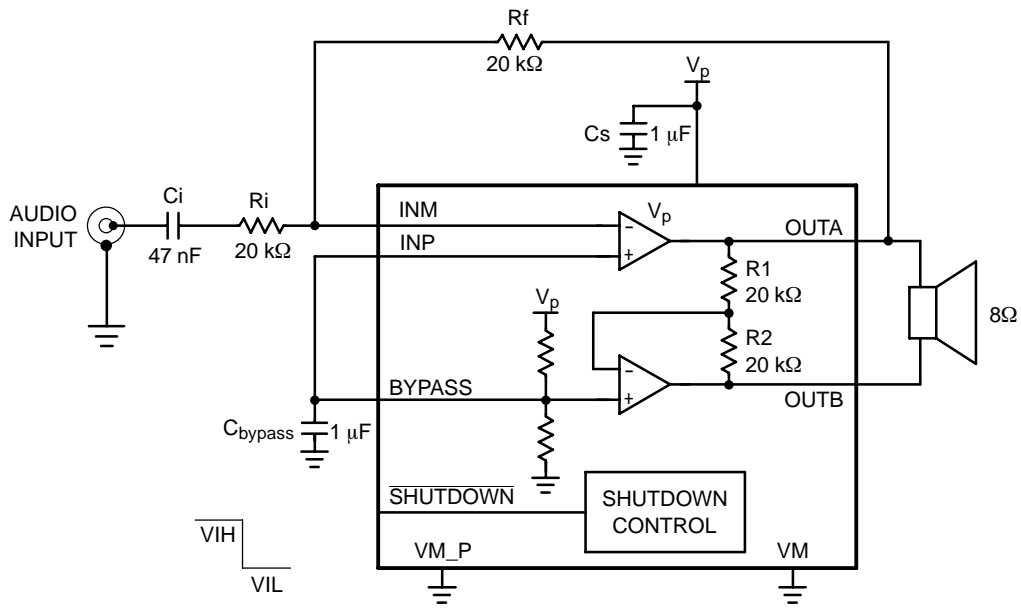

Figure 1. Typical Audio Amplifier Application Circuit with Single Ended Input

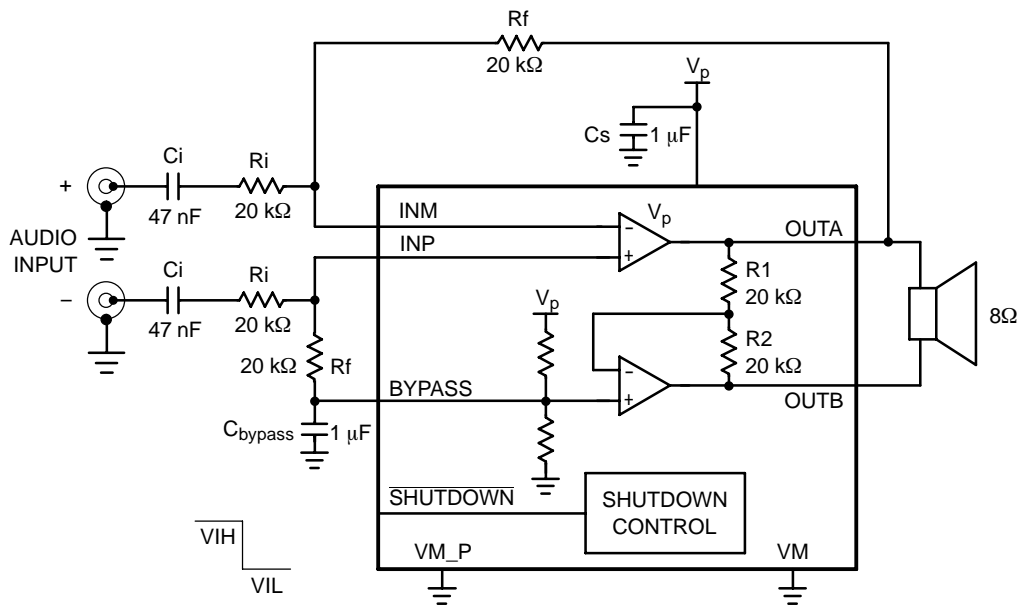

Figure 2. Typical Audio Amplifier Application Circuit with a Differential Input

This device contains 671 active transistors and 1899 MOS gates.

NCP2892 Series

PIN DESCRIPTION

Pin	Type	Symbol	Description
A1	I	INM	Negative input of the first amplifier, receives the audio input signal. Connected to the feedback resistor R_f and to the input resistor R_{in} .
A2	O	OUTA	Negative output of the NCP2892. Connected to the load and to the feedback resistor R_f .
A3	I	INP	Positive input of the first amplifier, receives the common mode voltage.
B1	I	VM_P	Power Analog Ground.
B2	I	VM	Core Analog Ground.
B3	I	V_p	Positive analog supply of the cell. Range: 2.2 V–5.5 V.
C1	I	BYPASS	Bypass capacitor pin which provides the common mode voltage ($V_p/2$).
C2	O	OUTB	Positive output of the NCP2892. Connected to the load.
C3	I	SHUTDOWN	The device enters in shutdown mode when a low level is applied on this pin.

MAXIMUM RATINGS (Note 1)

Rating	Symbol	Value	Unit
Supply Voltage	V_p	6.0	V
Operating Supply Voltage	Op V_p	2.2 to 5.5 V 2.0 V = Functional Only	–
Input Voltage	V_{in}	–0.3 to $V_{cc} + 0.3$	V
Max Output Current	I_{out}	500	mA
Power Dissipation (Note 2)	P_d	Internally Limited	–
Operating Ambient Temperature	T_A	–40 to +85	°C
Max Junction Temperature	T_J	150	°C
Storage Temperature Range	T_{stg}	–65 to +150	°C
Thermal Resistance Junction-to-Air	$R_{\theta JA}$	(Note 3)	°C/W
ESD Protection	Human Body Model (HBM) (Note 4) NCP2892A NCP2892B Machine Model (MM) (Note 5)	– 8000 6000 >250	V
Latchup Current at $T_A = 85^\circ\text{C}$ (Note 6)	–	± 100	mA

Stresses exceeding Maximum Ratings may damage the device. Maximum Ratings are stress ratings only. Functional operation above the Recommended Operating Conditions is not implied. Extended exposure to stresses above the Recommended Operating Conditions may affect device reliability.

- Maximum electrical ratings are defined as those values beyond which damage to the device may occur at $T_A = +25^\circ\text{C}$.
- The thermal shutdown set to 160°C (typical) avoids irreversible damage on the device due to power dissipation. For further information see page 10.
- The $R_{\theta JA}$ is highly dependent of the PCB Heatsink area. For example, $R_{\theta JA}$ can equal 195°C/W with 50 mm^2 total area and also 135°C/W with 500 mm^2 . For further information see page 10. The bumps have the same thermal resistance and all need to be connected to optimize the power dissipation.
- Human Body Model, 100 pF discharge through a 1.5 k Ω resistor following specification JESD22/A114.
- Machine Model, 200 pF discharged through all pins following specification JESD22/A115.
- Maximum ratings per JEDEC standard JESD78.

NCP2892 Series

ELECTRICAL CHARACTERISTICS Limits apply for T_A between -40°C to $+85^{\circ}\text{C}$ (Unless otherwise noted).

Characteristic	Symbol	Conditions	Min (Note 7)	Typ	Max (Note 7)	Unit
Supply Quiescent Current	I_{dd}	$V_p = 2.6\text{ V}$, No Load	–	1.5	4	mA
		$V_p = 5.0\text{ V}$, No Load	–	1.7		
		$V_p = 2.6\text{ V}$, $8\ \Omega$ $V_p = 5.0\text{ V}$, $8\ \Omega$	– –	1.7 1.9	5.5	
Common Mode Voltage	V_{cm}	–	–	$V_p/2$	–	V
Shutdown Current	I_{SD}	$T_A = +25^{\circ}\text{C}$ $T_A = -40^{\circ}\text{C}$ to $+85^{\circ}\text{C}$	–	0.01	0.5 1.0	μA
Shutdown Voltage High	V_{SDIH}	–	1.2	–	–	V
Shutdown Voltage Low	V_{SDIL}	–	–	–	0.4	V
Turning On Time (Note 9)	T_{WU}	$C_{by} = 1\ \mu\text{F}$	–	90	–	ms
Turning Off Time	T_{OFF}	–	–	1.0	–	μs
Output Impedance in Shutdown Mode NCP2892A NCP2892B	Z_{SD}	–	–	100	–	Ω
			–	10	–	k Ω
Output Swing NCP2892A	$V_{loadpeak}$	$V_p = 2.6\text{ V}$, $R_L = 8.0\ \Omega$	1.6	2.12	–	V
		$V_p = 5.0\text{ V}$, $R_L = 8.0\ \Omega$ (Note 8) $T_A = +25^{\circ}\text{C}$	4.0	4.15	–	
		$T_A = -40^{\circ}\text{C}$ to $+85^{\circ}\text{C}$	3.85			
Output Swing NCP2892B	$V_{loadpeak}$	$V_p = 2.6\text{ V}$, $R_L = 8.0\ \Omega$	1.6	2.20	–	V
		$V_p = 5.0\text{ V}$, $R_L = 8.0\ \Omega$ (Note 8) $T_A = +25^{\circ}\text{C}$	4.0	4.50	–	
		$T_A = -40^{\circ}\text{C}$ to $+85^{\circ}\text{C}$	3.85			
Rms Output Power NCP2892A	P_O	$V_p = 2.6\text{ V}$, $R_L = 4.0\ \Omega$ THD + N < 0.1%	–	0.36	–	W
		$V_p = 2.6\text{ V}$, $R_L = 8.0\ \Omega$ THD + N < 0.1%	–	0.28	–	
		$V_p = 5.0\text{ V}$, $R_L = 8.0\ \Omega$ THD + N < 0.1%	–	1.08	–	
Rms Output Power NCP2892B	P_O	$V_p = 2.6\text{ V}$, $R_L = 4.0\ \Omega$ THD + N < 0.1%	–	0.40	–	W
		$V_p = 2.6\text{ V}$, $R_L = 8.0\ \Omega$ THD + N < 0.1%	–	0.30	–	
		$V_p = 5.0\text{ V}$, $R_L = 8.0\ \Omega$ THD + N < 0.1%	–	1.20	–	
Maximum Power Dissipation (Note 9)	P_{Dmax}	$V_p = 5.0\text{ V}$, $R_L = 8.0\ \Omega$	–	–	0.65	W
Output Offset Voltage	V_{OS}	$V_p = 2.6\text{ V}$ $V_p = 5.0\text{ V}$	–30		30	mV
Signal-to-Noise Ratio	SNR	$V_p = 2.6\text{ V}$, $G = 2.0$ $10\text{ Hz} < F < 20\text{ kHz}$	–	84	–	dB
		$V_p = 5.0\text{ V}$, $G = 10$ $10\text{ Hz} < F < 20\text{ kHz}$	–	77	–	
Positive Supply Rejection Ratio	PSRR V_+	$G = 2.0$, $R_L = 8.0\ \Omega$ $V_{Pripple_pp} = 200\text{ mV}$ $C_{by} = 1.0\ \mu\text{F}$ Input Terminated with $10\ \Omega$ $F = 217\text{ Hz}$				dB
		$V_p = 5.0\text{ V}$	–	–64	–	
		$V_p = 3.0\text{ V}$	–	–72	–	
		$V_p = 2.6\text{ V}$	–	–73	–	
		$F = 1.0\text{ kHz}$				
		$V_p = 5.0\text{ V}$	–	–64	–	
$V_p = 3.0\text{ V}$	–	–74	–			
$V_p = 2.6\text{ V}$	–	–75	–			
Efficiency	η	$V_p = 2.6\text{ V}$, $P_{orms} = 320\text{ mW}$	–	48	–	%
		$V_p = 5.0\text{ V}$, $P_{orms} = 1.0\text{ W}$	–	63	–	

NCP2892 Series

ELECTRICAL CHARACTERISTICS Limits apply for T_A between -40°C to $+85^{\circ}\text{C}$ (Unless otherwise noted).

Characteristic	Symbol	Conditions	Min (Note 7)	Typ	Max (Note 7)	Unit
Thermal Shutdown Temperature (Note 10)	T_{sd}		140	160	180	$^{\circ}\text{C}$
Total Harmonic Distortion	THD	$V_p = 2.6$, $F = 1.0$ kHz $R_L = 4.0 \Omega$, $A_V = 2.0$ $P_O = 0.32$ W	–	–	–	%
		$V_p = 5.0$ V, $F = 1.0$ kHz $R_L = 8.0 \Omega$, $A_V = 2.0$ $P_O = 1.0$ W	–	–	–	

7. Min/Max limits are guaranteed by design, test or statistical analysis.
8. This parameter is guaranteed but not tested in production in case of a 5.0 V power supply.
9. See page 12 for a theoretical approach of this parameter.
10. For this parameter, the Min/Max values are given for information.

NCP2892 Series

TYPICAL PERFORMANCE CHARACTERISTICS

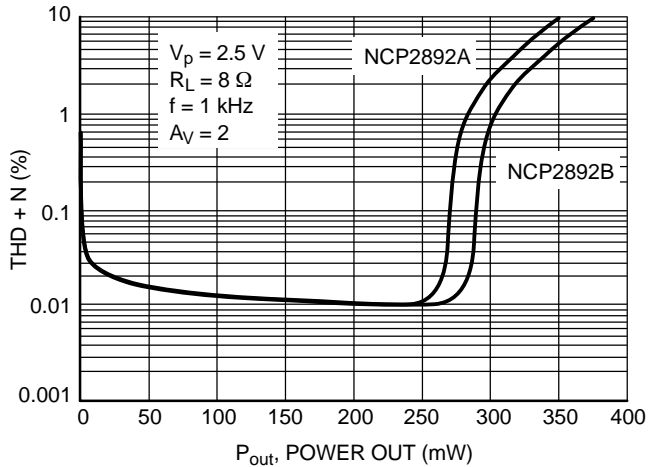

Figure 3. THD + N versus Power Out

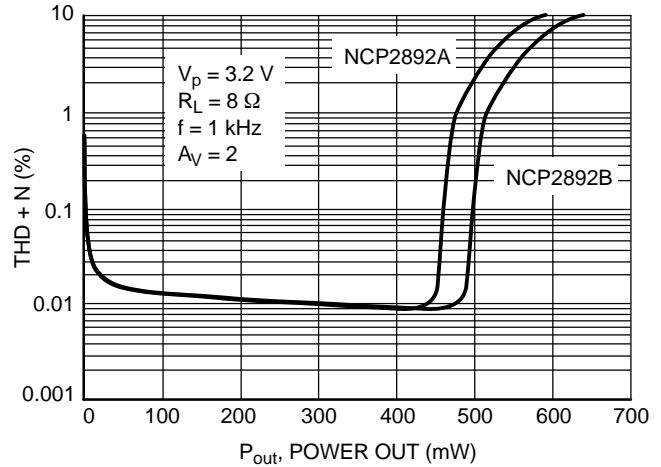

Figure 4. THD + N versus Power Out

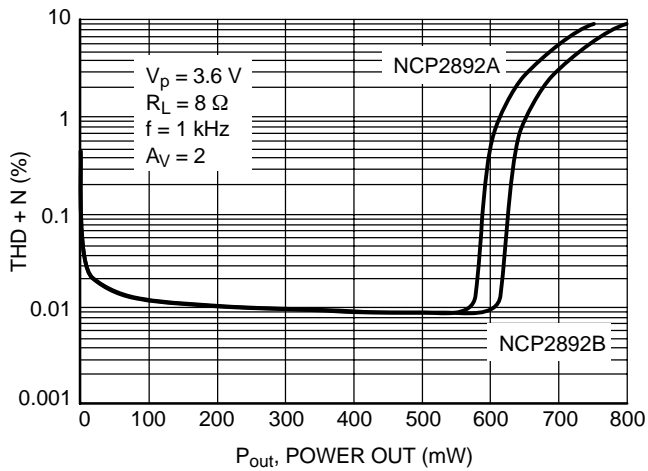

Figure 5. THD + N versus Power Out

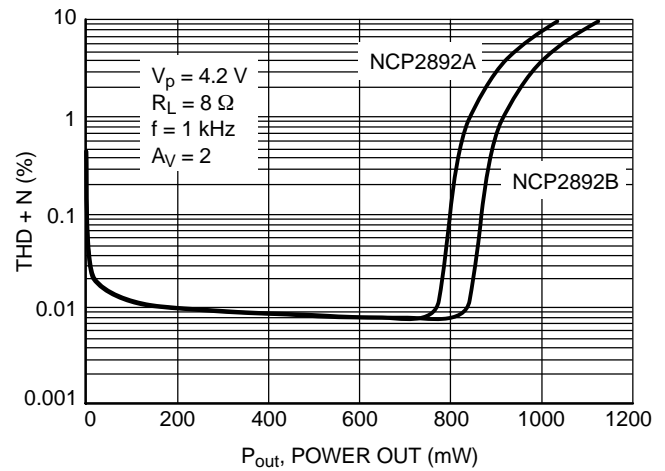

Figure 6. THD + N versus Power Out

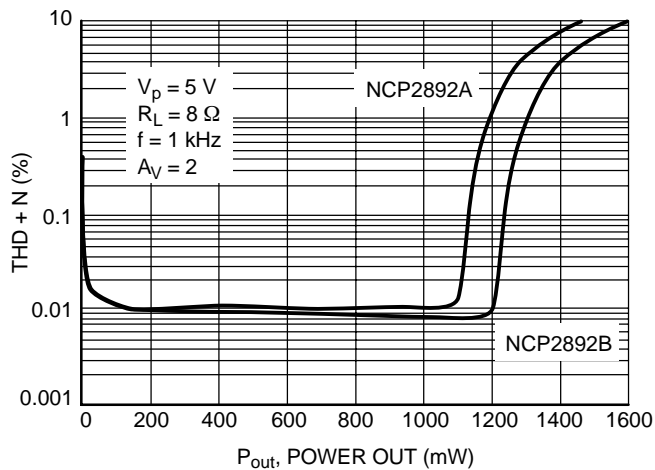

Figure 7. THD + N versus Power Out

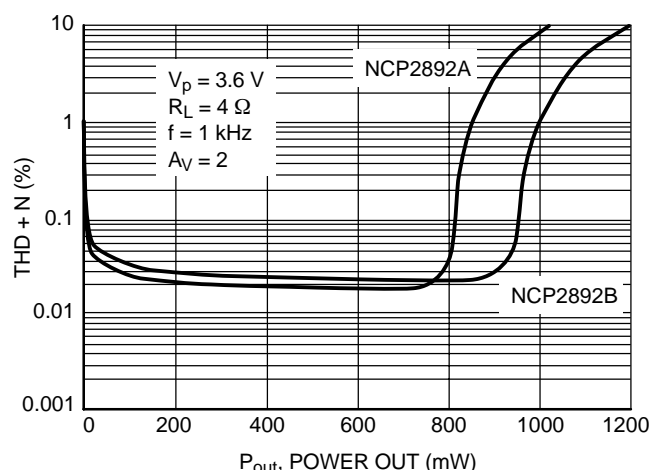

Figure 8. THD + N versus Power Out

NCP2892 Series

TYPICAL PERFORMANCE CHARACTERISTICS

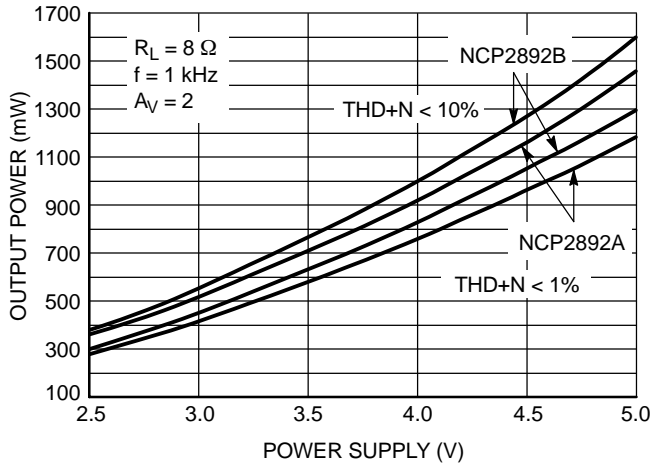

Figure 9. Output Power versus Power Supply

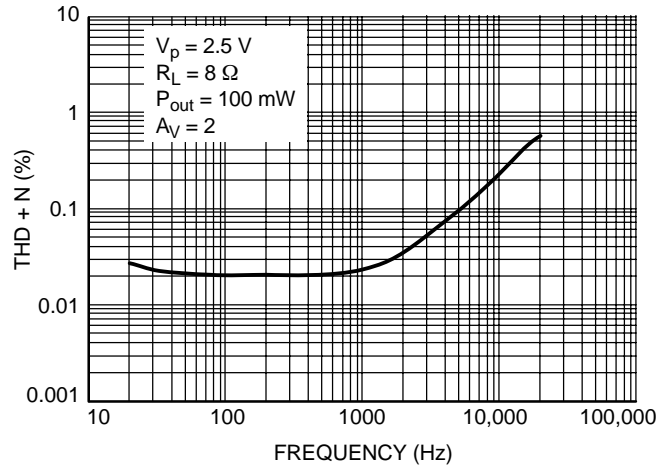

Figure 10. THD + N versus Frequency

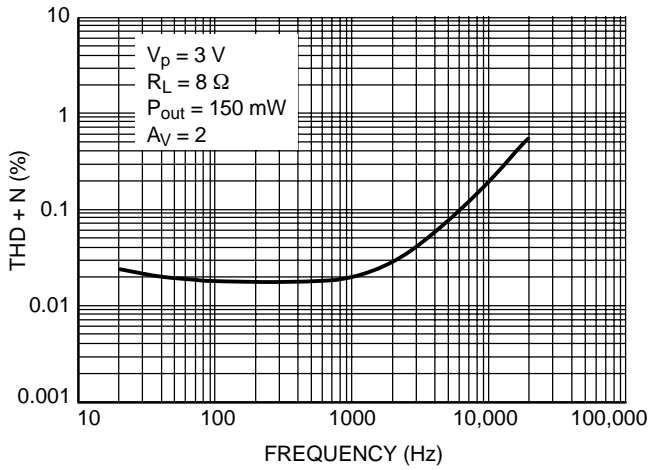

Figure 11. THD + N versus Frequency

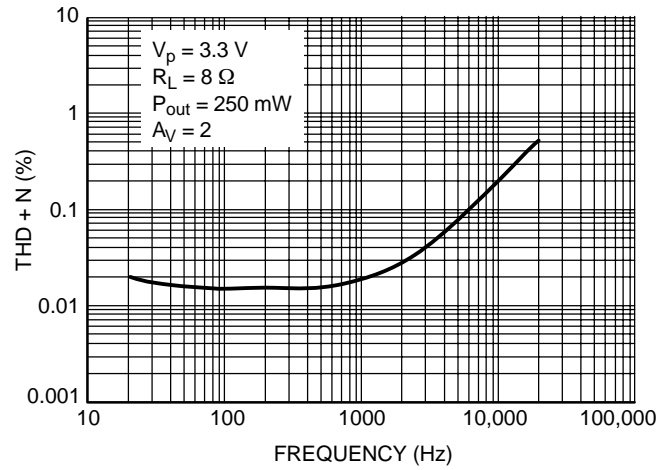

Figure 12. THD + N versus Frequency

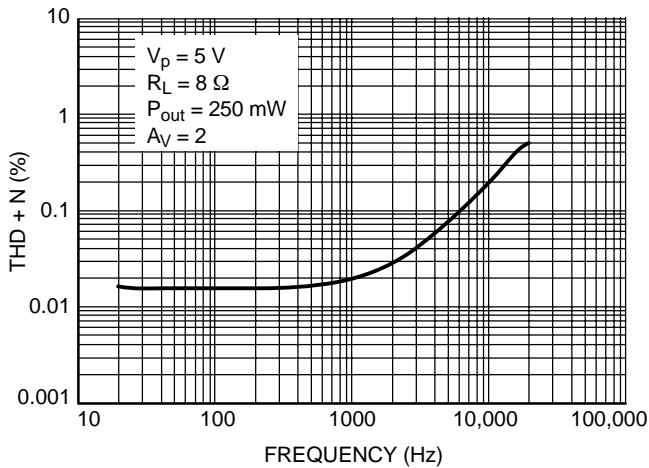

Figure 13. THD + N versus Frequency

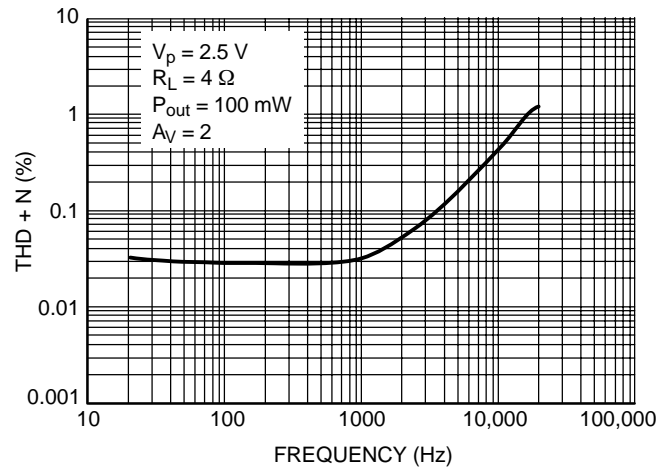

Figure 14. THD + N versus Frequency

TYPICAL PERFORMANCE CHARACTERISTICS

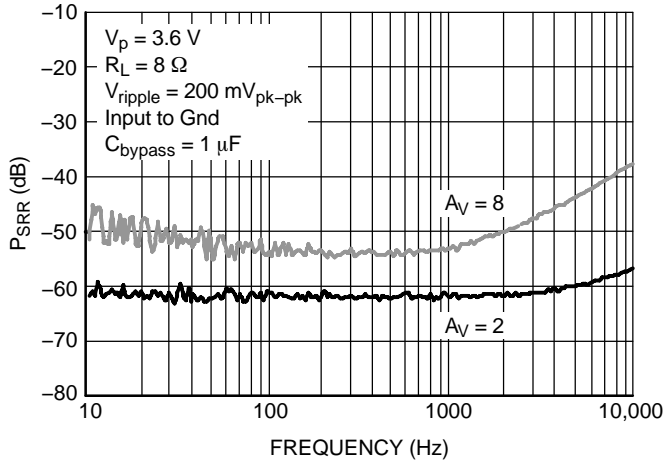

Figure 15. P_{SRR} @ $V_p = 3.6\text{ V}$
Single Ended Audio Input to Ground

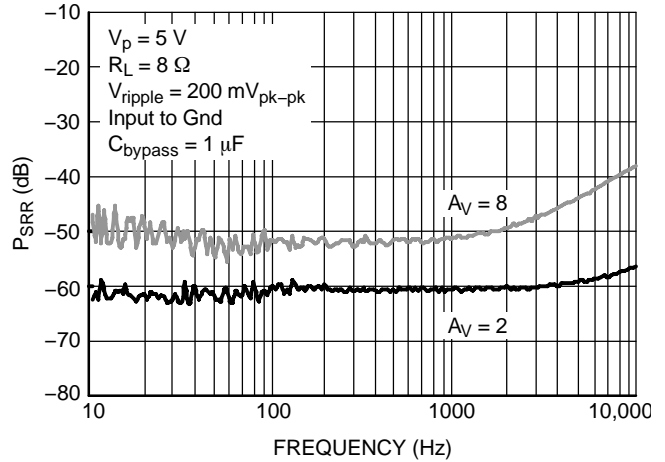

Figure 16. P_{SRR} @ $V_p = 5\text{ V}$
Single Ended Audio Input to Ground

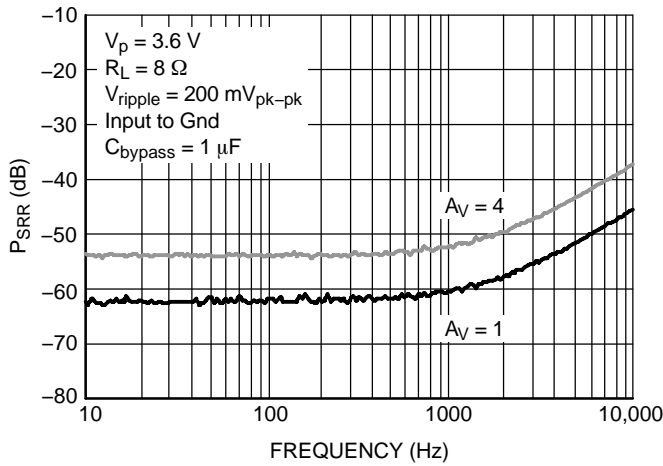

Figure 17. P_{SRR} @ $V_p = 3.6\text{ V}$
Differential Audio Input to Ground

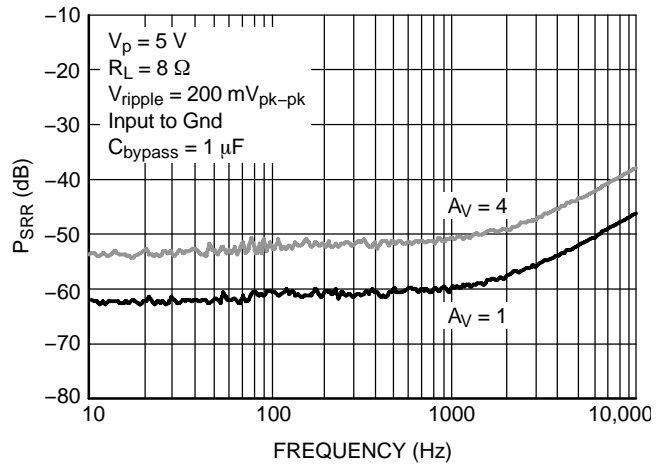

Figure 18. P_{SRR} @ $V_p = 5\text{ V}$
Differential Audio Input to Ground

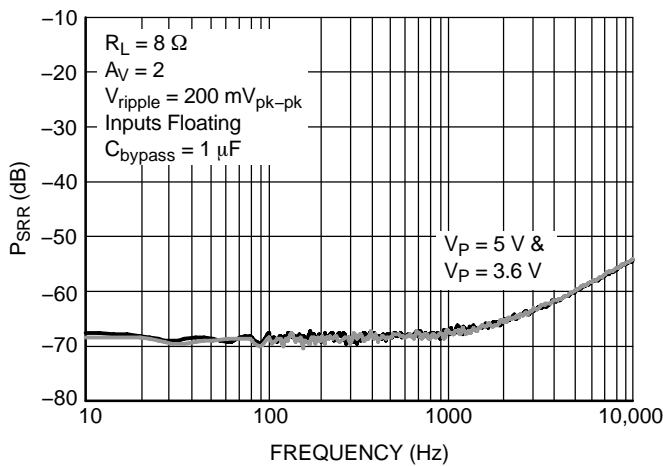

Figure 19. P_{SRR} @ $V_p = 3.6\text{ V}$
Single Ended Audio Input Floating

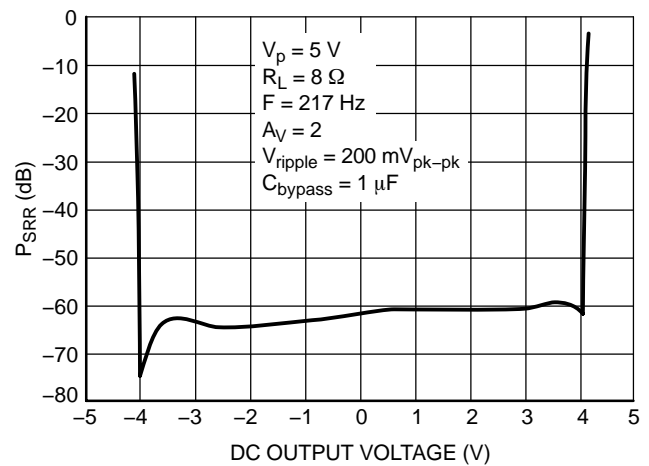

Figure 20. P_{SRR} @ DC Output Voltage

NCP2892 Series

TYPICAL PERFORMANCE CHARACTERISTICS

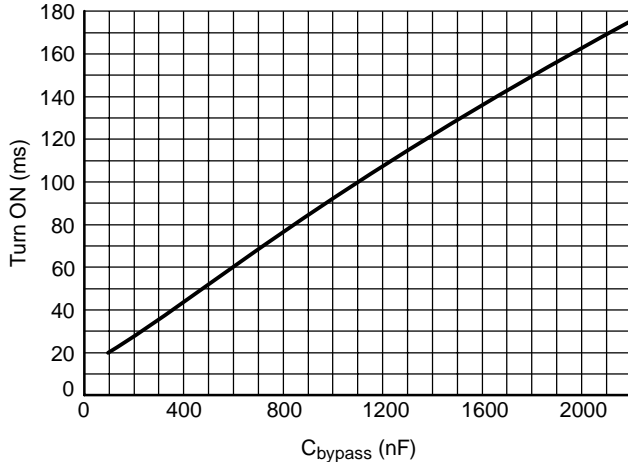

Figure 21. T_{ON} versus C_{bypass} @ $V_{bat} = 3.6$ V, $T_A = +25^\circ\text{C}$

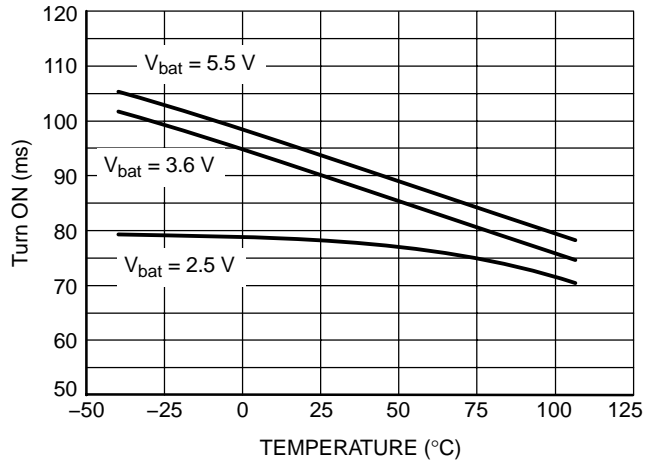

Figure 22. T_{ON} versus Temperature @ $V_{bat} = 3.6$ V, $C_{bypass} = 1 \mu\text{F}$

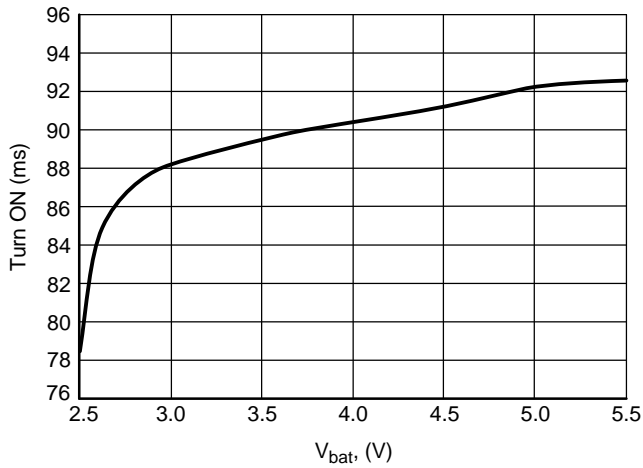

Figure 23. T_{ON} vs. V_{bat} @ $C_{bypass} = 1 \mu\text{F}$, $T_A = +25^\circ\text{C}$

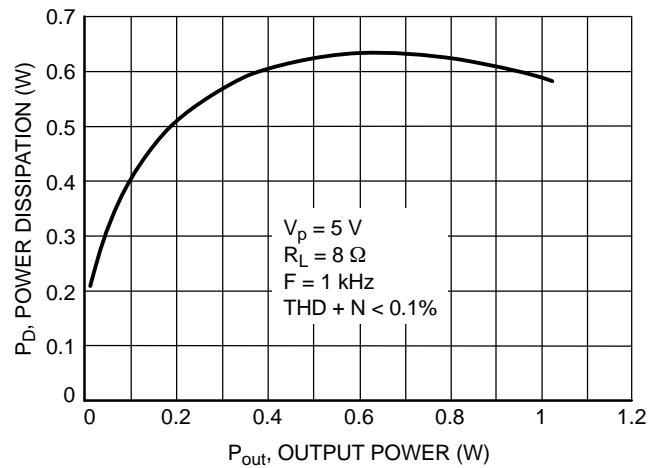

Figure 24. Power Dissipation versus Output Power

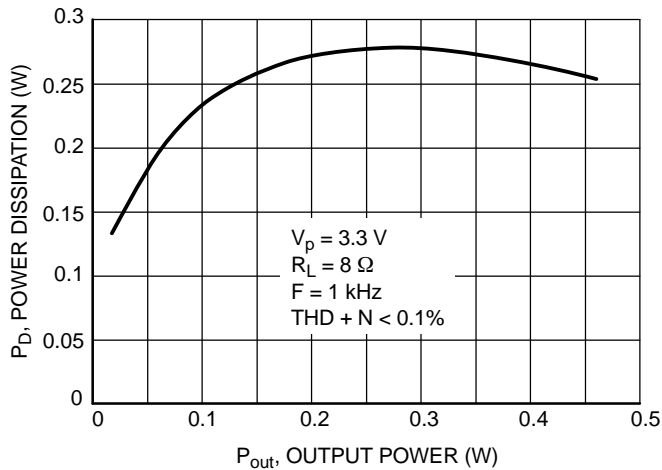

Figure 25. Power Dissipation versus Output Power

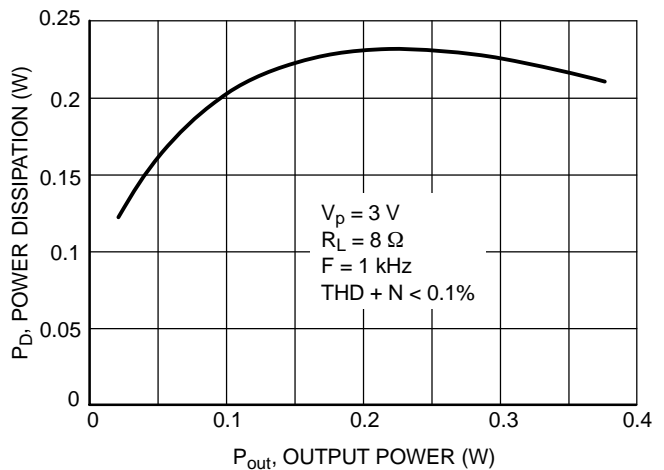

Figure 26. Power Dissipation versus Output Power

NCP2892 Series

TYPICAL PERFORMANCE CHARACTERISTICS

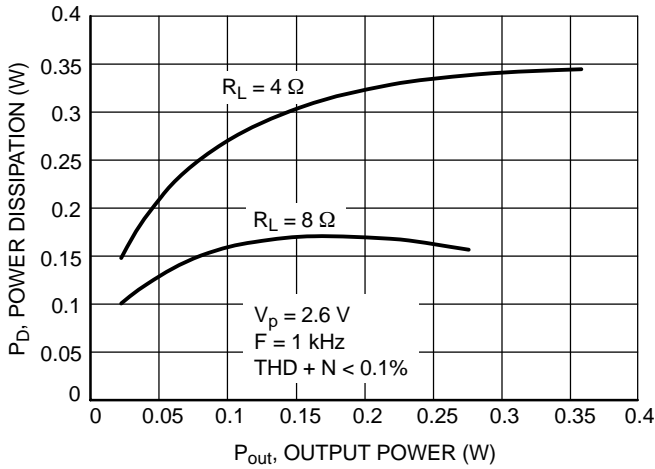

Figure 27. Power Dissipation versus Output Power

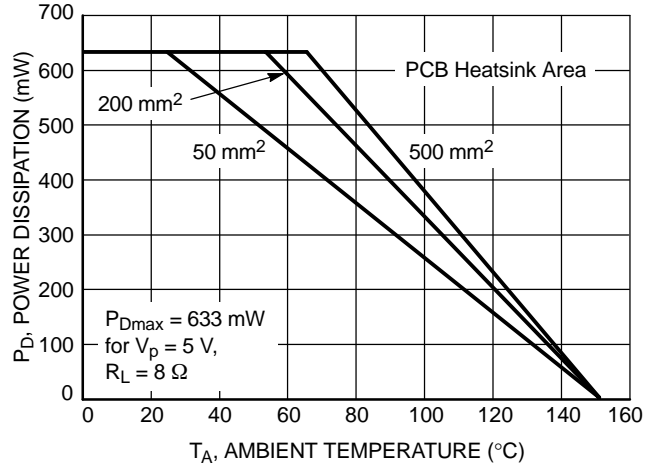

Figure 28. Power Derating – 9-Pin Flip-Chip CSP

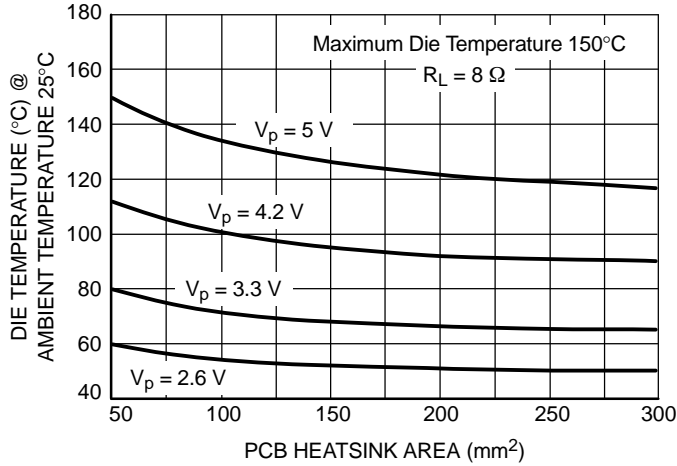

Figure 29. Maximum Die Temperature versus PCB Heatsink Area

TYPICAL PERFORMANCE CHARACTERISTICS

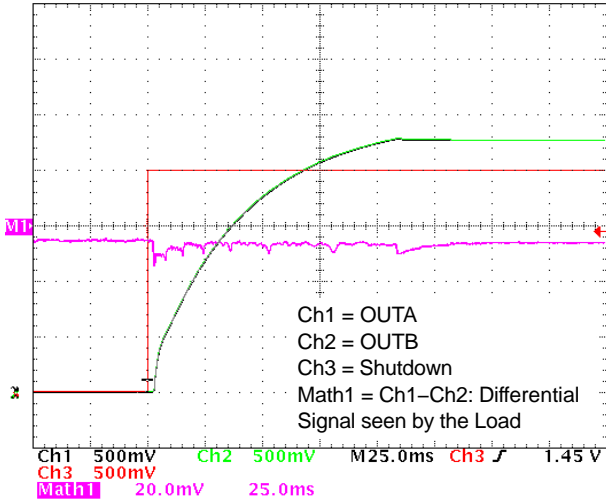

Figure 30. Zero Pop Noise Turn On Sequence with Differential Input to Ground; $C_{in} = 100 \text{ nF}$, $R_{in} = 24 \Omega$, $R_f = 100 \text{ k}\Omega$, $C_{byp} = 1 \mu\text{F}$, $R_L = 8 \Omega$

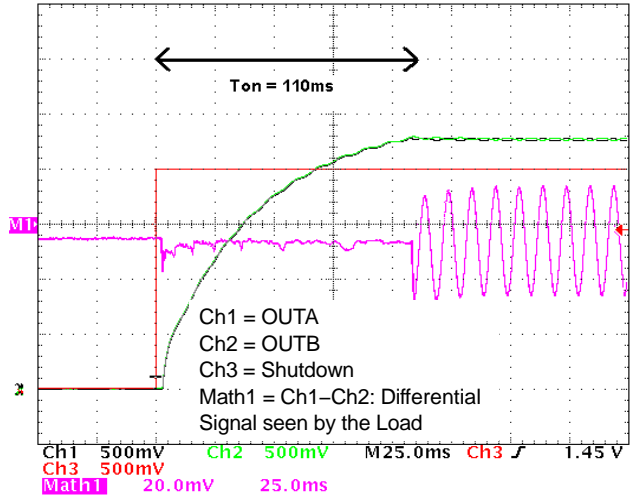

Figure 31. Zero Pop Noise Turn On Sequence with Differential Audio Source; $C_{in} = 100 \text{ nF}$, $R_{in} = 24 \Omega$, $R_f = 100 \text{ k}\Omega$, $C_{byp} = 1 \mu\text{F}$, $R_L = 8 \Omega$

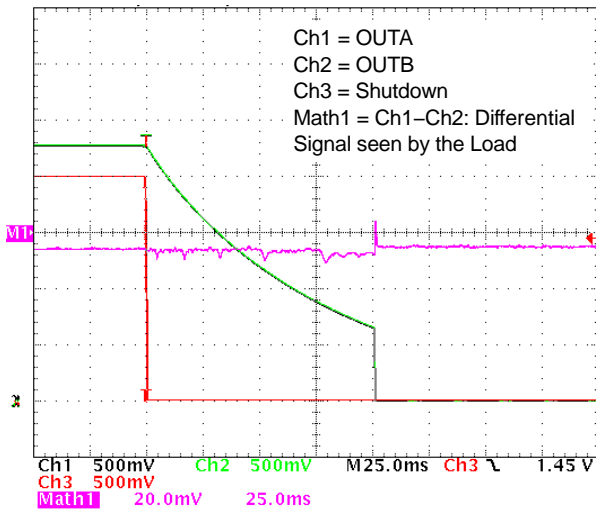

Figure 32. Zero Pop Noise Turn Off Sequence with Differential Input to Ground; $C_{in} = 100 \text{ nF}$, $R_{in} = 24 \Omega$, $R_f = 100 \text{ k}\Omega$, $C_{byp} = 1 \mu\text{F}$, $R_L = 8 \Omega$

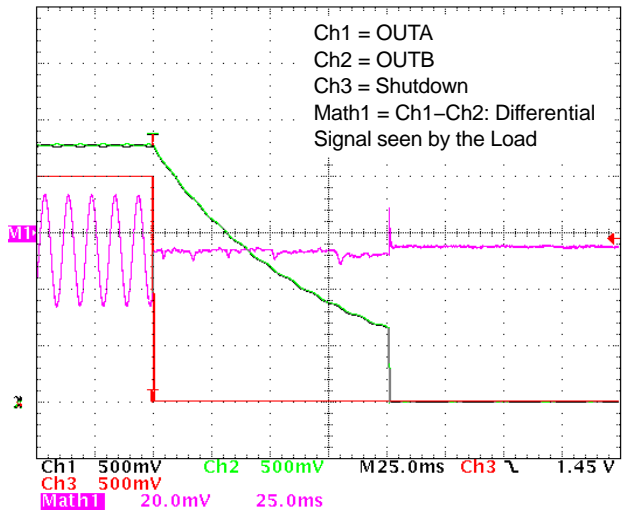

Figure 33. Zero Pop Noise Turn Off Sequence with Differential Audio Source; $C_{in} = 100 \text{ nF}$, $R_{in} = 24 \Omega$, $R_f = 100 \text{ k}\Omega$, $C_{byp} = 1 \mu\text{F}$, $R_L = 8 \Omega$

APPLICATION INFORMATION

Detailed Description

The NCP2892 audio amplifier can operate under 2.6 V until 5.5 V power supply. With less than 1% THD+N, B version can deliver up to 1.2 W rms output power to an 8.0 Ω load ($V_p = 5.0$ V). If application allows to reach 10% THD+N, then 1.6 W can be provided using a 5.0 V power supply.

The structure of the NCP2892 is basically composed of two identical internal power amplifiers; the first one is externally configurable with gain-setting resistors R_{in} and R_f (the closed-loop gain is fixed by the ratios of these resistors) and the second is internally fixed in an inverting unity-gain configuration by two resistors of 20 k Ω . So the load is driven differentially through OUTA and OUTB outputs. This configuration eliminates the need for an output coupling capacitor. The NCP2892A has around 100 Ω and the NCP2892B has around 10 k Ω output impedance in the shutdown mode.

Internal Power Amplifier

The output PMOS and NMOS transistors of the amplifier were designed to deliver the output power of the specifications without clipping. The channel resistance (R_{on}) of the NMOS and PMOS transistors does not exceed 0.6 Ω when they drive current.

The structure of the internal power amplifier is composed of three symmetrical gain stages, first and medium gain stages are transconductance gain stages to obtain maximum bandwidth and DC gain.

Turn-On and Turn-Off Transitions

A cycle with a turn-on and turn-off transition is illustrated with plots that show both single ended signals on the previous page.

In order to eliminate “pop and click” noises during transitions, output power in the load must be slowly established or cut. When logic high is applied to the shutdown pin, the bypass voltage begins to rise exponentially and once the output DC level is around the common mode voltage, the gain is established instantaneously. This way to turn-on the device is optimized in terms of rejection of “pop and click” noises.

The device has the same behavior when it is turned-off by a logic low on the shutdown pin. During the shutdown mode, amplifier outputs are connected to the ground.

When a shutdown low level is applied, with 1 μ F bypass capacitor, it takes 65 ms before the DC output level is tied to Ground on each output. However, no audio signal will be provided to the BTL load only 1 μ s after the falling edge on the shutdown pin.

With 1 μ F bypass capacitor, turn on time is set to 90 ms. This fast turn on time added to a very low shutdown current saves battery life and brings flexibility when designing the audio section of the final application.

NCP2892 is a zero pop noise device when using a differential audio input. In case of a single ended one, there

is no audible pop click noise, especially when the input cut off frequency is higher than 100 Hz.

Shutdown Function

The device enters shutdown mode when shutdown signal is low. During the shutdown mode, the DC quiescent current of the circuit does not exceed 100 nA. In this configuration, the output impedance is 10 k Ω on each output.

Current Limit Circuit

The maximum output power of the circuit ($P_{orms} = 1.0$ W, $V_p = 5.0$ V, $R_L = 8.0$ Ω) requires a peak current in the load of 500 mA.

In order to limit the excessive power dissipation in the load when a short-circuit occurs, the current limit in the load is fixed to 800 mA. The current in the four output MOS transistors are real-time controlled, and when one current exceeds 800 mA, the gate voltage of the MOS transistor is clipped and no more current can be delivered.

Thermal Overload Protection

Internal amplifiers are switched off when the temperature exceeds 160°C, and will be switched on again only when the temperature decreases fewer than 140°C.

The NCP2892 is unity-gain stable and requires no external components besides gain-setting resistors, an input coupling capacitor and a proper bypassing capacitor in the typical application.

The first amplifier is externally configurable (R_f and R_{in}), while the second is fixed in an inverting unity gain configuration.

The differential-ended amplifier presents two major advantages:

- The possible output power is four times larger (the output swing is doubled) as compared to a single-ended amplifier under the same conditions.
- Output pins (OUTA and OUTB) are biased at the same potential $V_p/2$, this eliminates the need for an output coupling capacitor required with a single-ended amplifier configuration.

The differential closed loop-gain of the amplifier is given by $A_{vd} = 2 * \frac{R_f}{R_{in}} = \frac{V_{orms}}{V_{inrms}}$.

Output power delivered to the load is given by $P_{orms} = \frac{(V_{opeak})^2}{2 * R_L}$ (V_{opeak} is the peak differential output voltage).

When choosing gain configuration to obtain the desired output power, check that the amplifier is not current limited or clipped.

The maximum current which can be delivered to the load is 500 mA $I_{opeak} = \frac{V_{opeak}}{R_L}$.

NCP2892 Series

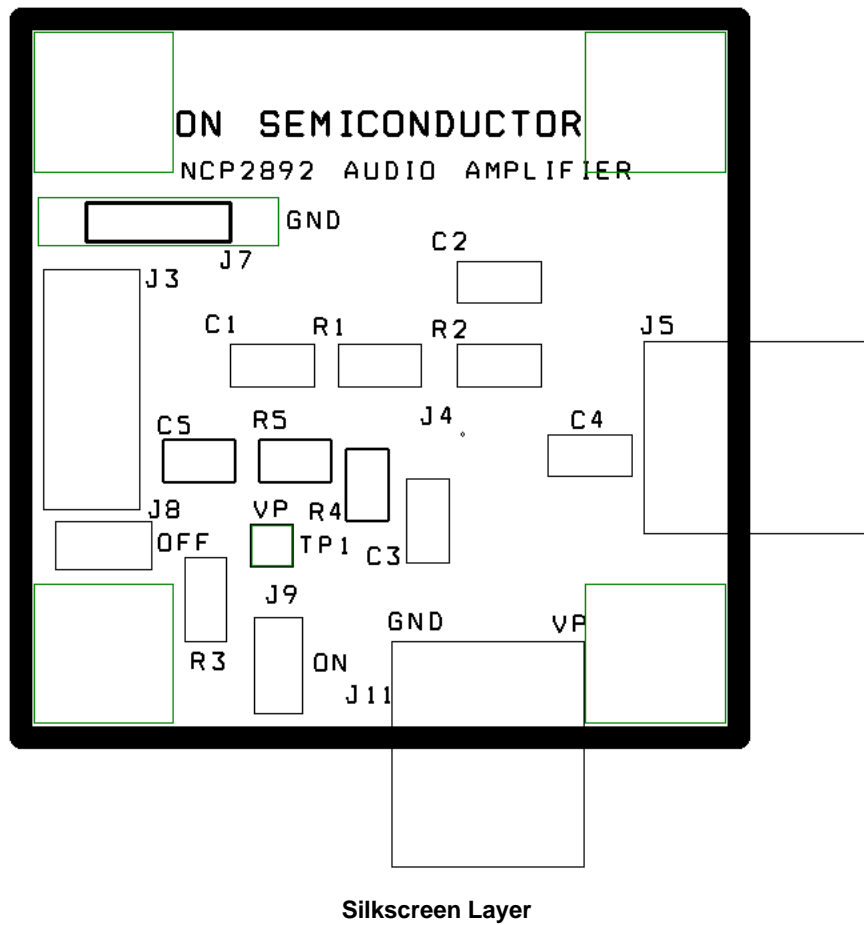

Figure 35. Demonstration Board for 9-Pin Flip-Chip CSP Device – PCB Layers

NCP2892 Series

BILL OF MATERIAL

Item	Part Description	Ref.	PCB Footprint	Manufacturer	Manufacturer Reference
1	NCP2892 Audio Amplifier	–	–	ON Semiconductor	NCP2892
2	SMD Resistor 20 K Ω	R1, R5	0805	Panasonic	ERJ-6GEYJ203V
3	SMD Resistor 100 K Ω	R2, R4	0805	Panasonic	ERJ-6GEYJ104V
4	SMD Resistor 150 K Ω	R3	0805	Panasonic	ERJ-6GEYJ154V
5	Ceramic Capacitor 100 nF, 100 V X7R	C1, C5	0805	TDK	C2012X7R2A473K
6	Ceramic Capacitor 1.0 μ F, 10 V X7R	C3, C4	0805	TDK	C2012X7R1A105K
7	Jumper Header Vertical Mount, 2 positions, 100 mils	J8, J9, J12	100 mils	Tyco Electronics / AMP	5-826629-0
8	I/O Connector, 2 positions	J5, J11	200 mils	Phoenix Contact	1757242
9	Jumper Connector	J7	400 mils	Harwin	D3082-B01
10	Not Mounted	C2, TP1	–	–	–

ORDERING INFORMATION

Device	Marking	Package	Shipping†
NCP2892AFCT2G	MAX	9-Pin Flip-Chip CSP (Pb-Free)	3000/Tape and Reel
NCP2892BFCT2G	MAZ	9-Pin Flip-Chip CSP (Pb-Free)	3000/Tape and Reel

†For information on tape and reel specifications, including part orientation and tape sizes, please refer to our Tape and Reel Packaging Specifications Brochure, BRD8011/D.

NOTE: The NCP2892AFCT2G version requires a lead-free solder paste and should not be used with a SnPb solder paste.

onsemi, **Onsemi**, and other names, marks, and brands are registered and/or common law trademarks of Semiconductor Components Industries, LLC dba "**onsemi**" or its affiliates and/or subsidiaries in the United States and/or other countries. **onsemi** owns the rights to a number of patents, trademarks, copyrights, trade secrets, and other intellectual property. A listing of **onsemi**'s product/patent coverage may be accessed at www.onsemi.com/site/pdf/Patent-Marking.pdf. **onsemi** reserves the right to make changes at any time to any products or information herein, without notice. The information herein is provided "as-is" and **onsemi** makes no warranty, representation or guarantee regarding the accuracy of the information, product features, availability, functionality, or suitability of its products for any particular purpose, nor does **onsemi** assume any liability arising out of the application or use of any product or circuit, and specifically disclaims any and all liability, including without limitation special, consequential or incidental damages. Buyer is responsible for its products and applications using **onsemi** products, including compliance with all laws, regulations and safety requirements or standards, regardless of any support or applications information provided by **onsemi**. "Typical" parameters which may be provided in **onsemi** data sheets and/or specifications can and do vary in different applications and actual performance may vary over time. All operating parameters, including "Typicals" must be validated for each customer application by customer's technical experts. **onsemi** does not convey any license under any of its intellectual property rights nor the rights of others. **onsemi** products are not designed, intended, or authorized for use as a critical component in life support systems or any FDA Class 3 medical devices or medical devices with a same or similar classification in a foreign jurisdiction or any devices intended for implantation in the human body. Should Buyer purchase or use **onsemi** products for any such unintended or unauthorized application, Buyer shall indemnify and hold **onsemi** and its officers, employees, subsidiaries, affiliates, and distributors harmless against all claims, costs, damages, and expenses, and reasonable attorney fees arising out of, directly or indirectly, any claim of personal injury or death associated with such unintended or unauthorized use, even if such claim alleges that **onsemi** was negligent regarding the design or manufacture of the part. **onsemi** is an Equal Opportunity/Affirmative Action Employer. This literature is subject to all applicable copyright laws and is not for resale in any manner.

ADDITIONAL INFORMATION

TECHNICAL PUBLICATIONS:

Technical Library: www.onsemi.com/design/resources/technical-documentation
onsemi Website: www.onsemi.com

ONLINE SUPPORT: www.onsemi.com/support

For additional information, please contact your local Sales Representative at www.onsemi.com/support/sales