

New

3-colour display Electromagnetic Type Digital Flow Switch



● Compact/Lightweight

● Weight: **340 g** (LFE1□3)

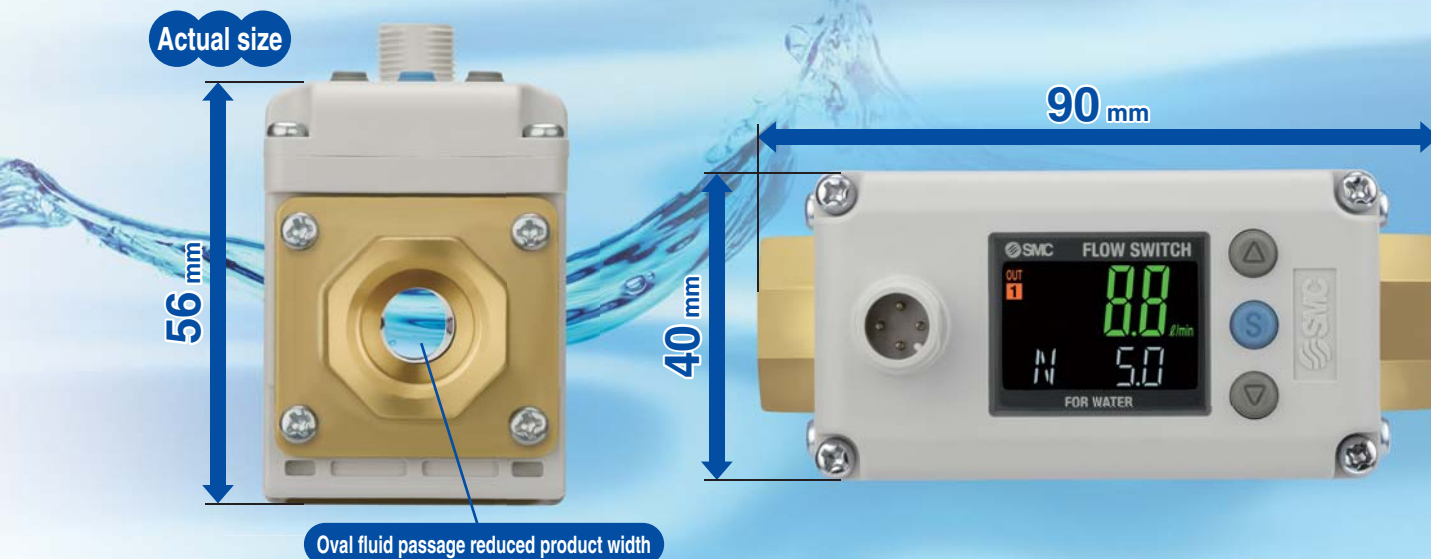

● Reverse flow can be detected.
Reverse flow error display

● Operating fluid temperature: **0 to 85 °C**
(Refer to page 4.)

● Current consumption: **45 mA**
Reduced by up to **10 %** when the display is off.



Reverse flow error (Code LLL)

Reverse flow

Integrated display type



● Applicable fluids: Water, Water-soluble coolant
(Refer to page 18.)

Variations

Integrated display type/ Remote type	Flow range							
	0.5 l/min	2 l/min	5 l/min	10 l/min	20 l/min	50 l/min	100 l/min	200 l/min
LFE1	Rated flow range				Display flow range			
LFE2	Rated flow range					Display flow range		
LFE3	Display flow range	Rated flow range						

Remote type



Sensor unit

3-colour display Monitor unit

Series **LFE** □



CAT.EUS100-107B-UK

● Pressure loss:
0.02 MPa or less



● Repeatability: **±1.5 % F.S.** (Analogue output)

● Flow direction can be changed after installation. ● **3-colour/2-screen display**

■ Default flow direction (Normal flow)



Instantaneous flow rate is displayed.

Parameters below can be set.

- Set value
- Flow direction
- Accumulated value
- Line name
- Peak/Bottom value

■ Flow direction can be changed after installation.

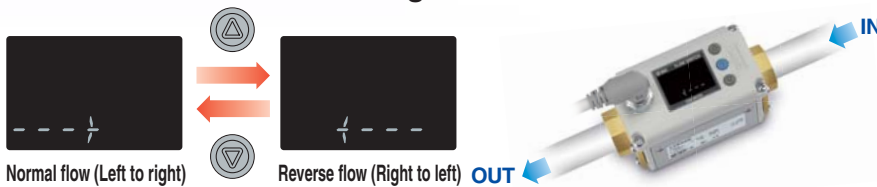

Application Examples

Flow control for pressurized cooling water for welding gun

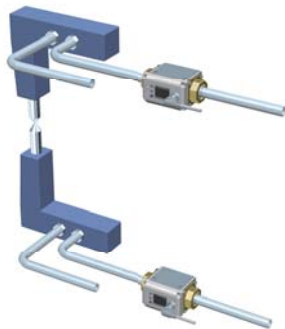

Flow control for water-soluble coolant

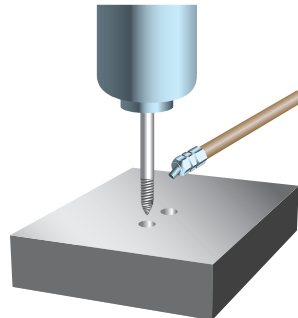

Flow control for cooling water for metal mold

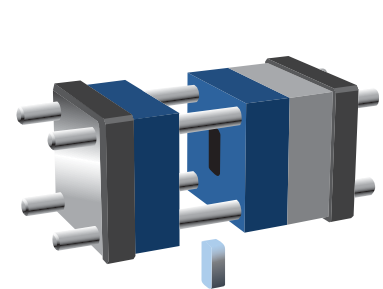

Principle

Faraday's law of induction

Measure the volume flow of inductive liquid by applying the Faraday's law of induction "when conductive object is moved through a magnetic field, electromotive force will be generated."



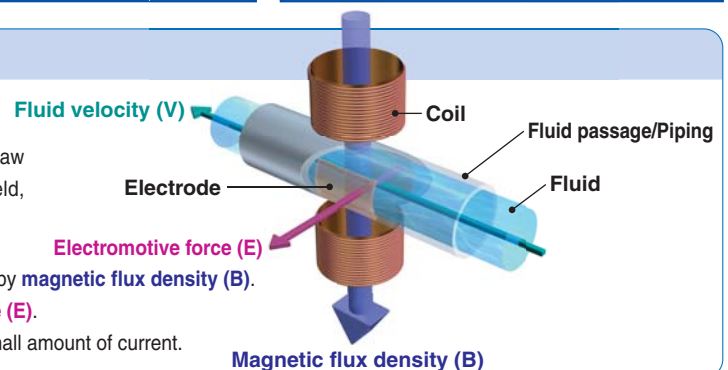

Electromotive force (E) is proportional to fluid velocity (V) multiplied by magnetic flux density (B).

Volume flow is calculated by converting measured electromotive force (E).

Oval fluid passage is used to improve the magnetic flux density by small amount of current.



Flow Switch for Liquid Variations

Series	Applicable fluid	Detection method	Minimum setting unit	Enclosure*	Display	Rated flow range [l/min]											
						0	0.5	2	5	10	20	30	40	50	100	150	200
LFE New 	Water/ Water-soluble coolant	Electromagnetic type	0.1 l/min	IP65	3-colour display	0.5	[Bar chart: 0.5 to 20]					20					
			0.5 l/min			2.5	[Bar chart: 2.5 to 100]					100					
			1 l/min			5	[Bar chart: 5 to 200]					200					
PF3W 	Water/ Ethylene glycol aqueous solution	Karman vortex	0.01 l/min	IP65	3-colour display	0.5	[Bar chart: 0.5 to 4]		4								
			0.1 l/min			2	[Bar chart: 2 to 16]		16								
			0.1 l/min			5	[Bar chart: 5 to 40]		40								
			1 l/min			10	[Bar chart: 10 to 100]		100								
			2 l/min			50	[Bar chart: 50 to 250]		250								
PVC piping type 	Water/ Ethylene glycol aqueous solution	Karman vortex	1 l/min	IP65	3-colour display	10	[Bar chart: 10 to 100]		100								
			2 l/min			30	[Bar chart: 30 to 250]		250								
PF2D 	Deionized water and Chemicals	Karman vortex	0.05 l/min	IP65	1-colour display	0.4	[Bar chart: 0.4 to 4]		4								
			0.1 l/min			1.8	[Bar chart: 1.8 to 20]		20								
			0.5 l/min			4	[Bar chart: 4 to 40]		40								

* For remote type monitor unit, only the front side is IP65 compliant. Other parts are IP40 compliant.

INDEX

3-Colour Display Electromagnetic Type Digital Flow Switch Series LFE

How to Order	P.1
Specifications (Integrated Display Type)	P.2
Specifications (Remote Type Sensor Unit)	P.3
Flow-rate Characteristics (Pressure Loss)	P.4
Internal Circuits and Wiring Examples	P.5
Parts Description	P.6
Dimensions	P.7

3-Colour Display Digital Flow Monitor Series LFE0

How to Order	P.8
Specifications	P.9
Internal Circuits and Wiring Examples	P.10
Parts Description (Remote Type Monitor Unit)	P.11
Dimensions	P.12

Function Details	P.13
Specific Product Precautions	P.16

3-colour display

Electromagnetic Type Digital Flow Switch

Series LFE



RoHS

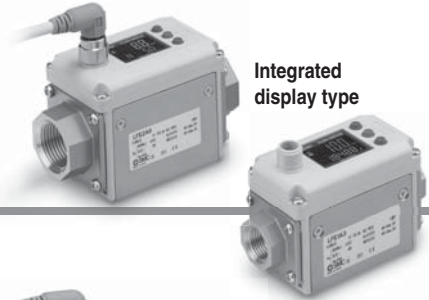

Integrated display type



Remote type sensor unit



Remote type monitor unit
(For details, refer to page 8.)

How to Order

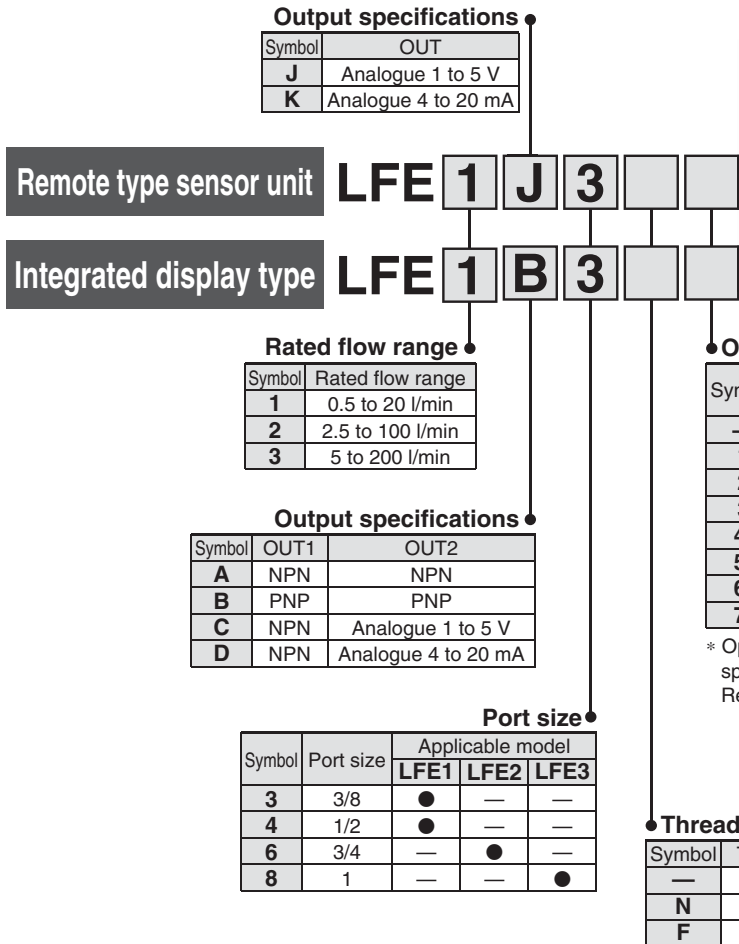

Option/Part No.

When only optional parts are required, order with the part number listed below.

Option	Part no.	Note	Weight
Lead wire with M12 connector	LFE-1-A3	Lead wire length 3 m	Approx. 175 g

Option	Part no.	Note	Weight
Bracket	LFE-1-D	Tapping screw for LFE1 (3 x 10), 4 pcs.	Approx. 45 g
	LFE-2-D	Tapping screw for LFE2 (3 x 10), 4 pcs.	Approx. 70 g
	LFE-3-D	Tapping screw for LFE3 (3 x 10), 4 pcs.	Approx. 70 g

Specifications (Integrated Display Type)

Model		LFE1	LFE2	LFE3
Applicable fluid <small>Note 1)</small>		Water, Conductive fluids which do not corrode the fluid contact materials. <small>Note 1)</small>		
Applicable fluid conductivity <small>Note 1)</small>		5 μ S/cm or more (micro siemens)		
Detection method		Electrostatic capacity type		
Ground <small>Note 10)</small>		Negative ground		
Rated flow range		0.5 to 20 l/min	2.5 to 100 l/min	5 to 200 l/min
Display flow range		0.4 to 24.0 l/min	2.0 to 120.0 l/min	4 to 240 l/min
Set flow range		0.4 to 24.0 l/min	2.0 to 120.0 l/min	4 to 240 l/min
Zero-cut flow <small>Note 2)</small>		0.4 l/min	2.0 l/min	4 l/min
Minimum setting unit		0.1 l/min	0.5 l/min	1 l/min
Accumulated volume per pulse (Pulse width: 50 ms)		0.1 l/pulse	0.5 l/pulse	1 l/pulse
Operating fluid temperature <small>Note 3)</small>		0 to 85 °C (with no freezing and condensation)		
Display units		Instantaneous flow rate l/min, Accumulated flow L		
Repeatability		Displayed values: ± 2 % F.S. Analogue output: ± 1.5 % F.S.		
Temperature characteristics	Ambient temperature	± 5 % F.S. (25 °C reference)		
	Fluid temperature	± 5 % F.S. (25 °C reference)		
Operating pressure range <small>Note 3)</small>		0 to 1 MPa		
Proof pressure <small>Note 3)</small>		2 MPa		
Accumulated flow range <small>Note 4)</small>		99999999.9 L by 0.1 L	99999999.9 L by 1 L	
Switch output		NPN or PNP open collector output		
Maximum load current		80 mA		
Maximum applied voltage		28 VDC		
Internal voltage drop		NPN: 1 V or less (at load current 80 mA) PNP: 1.5 V or less (at load current 80 mA)		
Response time <small>Note 5) 7)</small>		0.25 s/0.5 s/1 s/2 s/5 s		
Output protection		Short-circuit protection		
Output mode		Select from hysteresis mode, window comparator mode, accumulated output mode, or accumulated pulse output mode.		
Response time <small>Note 6) 7)</small>		0.25 s/0.5 s/1 s/2 s/5 s		
Analogue output	Voltage output	Output voltage: 1 to 5 V Output impedance: 1 k Ω		
	Current output	Output current: 4 to 20 mA Max. load impedance: 600 Ω		
Hysteresis		Variable		
Display method		2-screen (Main screen: 4-digit, 7-segment, 2-colour, Red/Green; Sub screen: 6-digit, 11-segment, White) Display values updated 5 times per second		
Status LED's		Output 1, Output 2: (Orange)		
Power supply voltage		24 VDC ± 10 %		
Current consumption		45 mA or less (Load current is not included.)		
Environmental resistance	Enclosure <small>Note 9)</small>	IP65		
	Operating temperature range	0 to 50 °C (with no freezing and condensation)		
	Operating humidity range	Operating, Storage: 35 to 85 % R.H. (with no condensation)		
Standards and regulations		CE marking, RoHS		
Parts material in contact with fluid		PPS, FKM, C37 (Brass)		
Port size		3/8 (10A)	1/2 (15A)	3/4 (20A)
Weight (Body) <small>Note 8)</small>		Approx. 340 g	Approx. 400 g	Approx. 520 g

Note 1) Refer to "Applicable Fluids List" on page 18.

Note 2) 0 l/min is displayed when the flow is less than zero-cut flow.

Note 3) When fluids with high temperature are used, the operating pressure range and proof pressure will be reduced. (For details, refer to "Operating Pressure Range" on page 4.)

Note 4) Cleared when the power supply is turned off. Hold function can be selected. (Interval of 2 or 5 minutes can be selected.) If the 5 minutes interval is selected, the life of the memory element (electronic parts) is limited to 1 million cycles. (If energized for 24 hours, life is calculated as 5 minutes x 1 million = 5 million minutes = about 9.5 years.) Therefore, if using the hold function, calculate the memory life for your operating conditions, and use within this life.

Note 5) The response time when the set value is 63 % in relation to the step input.

Note 6) The response time until the set value reaches 63 % in relation to the step input. There might be a 0.05 seconds delay at response time of 0.25 s or 0.5 s due to the timing of internal processing.

Note 7) The stability of display and analogue output is improved by increasing the response time setting. (For details, refer to "Stability" on page 4.)

Note 8) When options are used, add the weight of the optional parts.

Note 9) Enclosure is for digital flow switch with lead wire and M12 connector. With no lead wire and M12 connector, enclosure is IP40.

Note 10) Piping port is grounded to DC(-)/blue line. Power supply with positive ground cannot be used. Please consult SMC if the product is used for positive ground environment.

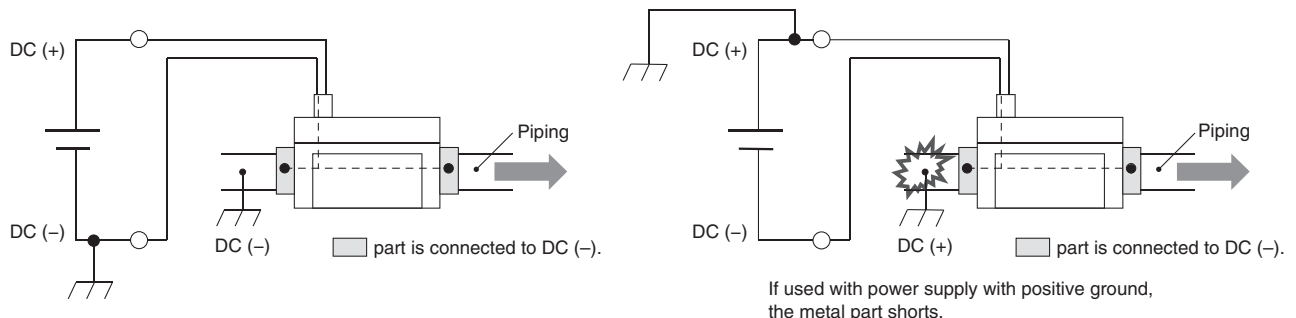

Specifications (Remote Type Sensor Unit)

Refer to page 9 for the monitor unit specifications.

Model	LFE1	LFE2	LFE3
Applicable fluid <small>Note 1)</small>	Water, Conductive fluids which do not corrode the fluid contact materials. <small>Note 1)</small>		
Applicable fluid conductivity <small>Note 1)</small>	5 μ S/cm or more (micro siemens)		
Detection method	Electrostatic capacity type		
Ground <small>Note 5)</small>	Negative ground		
Rated flow range	0.5 to 20 l/min	2.5 to 100 l/min	5 to 200 l/min
Operating fluid temperature <small>Note 2)</small>	0 to 85 °C (with no freezing and condensation)		
Repeatability	Analogue output: ± 1.5 % F.S.		
Temperature characteristics	Ambient temperature	± 5 % F.S. (25 °C reference)	
	Fluid temperature	± 5 % F.S. (25 °C reference)	
Operating pressure range <small>Note 2)</small>	0 to 1 MPa		
Proof pressure <small>Note 2)</small>	2 MPa		
Analogue output	Response time <small>Note 3)</small>	0.5 s	
	Voltage output	Output voltage: 1 to 5 V Output impedance: 1 k Ω	
	Current output	Output current: 4 to 20 mA Max. load impedance: 600 Ω	
Power supply voltage	24 VDC ± 10 %		
Current consumption	42 mA or less (Load current is not included.)		
Environmental resistance	Enclosure	IP65	
	Operating temperature range	0 to 50 °C (with no freezing and condensation)	
	Operating humidity range	Operating, Storage: 35 to 85 % R.H. (with no condensation)	
Standards and regulations	CE marking, RoHS		
Parts material in contact with fluid	PPS, FKM, C37 (Brass)		
Port size	3/8 (10A)	1/2 (15A)	3/4 (20A)
Weight (Body) <small>Note 4)</small>	Approx. 335 g	Approx. 395 g	Approx. 515 g

Note 1) Refer to "Applicable Fluids List" on page 18.

Note 2) When fluids with high temperature are used, the available pressure range will be reduced. (For details, refer to "Operating Pressure Range" on page 4.)

Note 3) The response time until the set value reaches 63 % in relation to the step input.

Note 4) When options are used, add the weight of the optional parts.

Note 5) Piping port and the metal part of the body are grounded to DC(-)/blue line. Power supply with positive ground cannot be used. Please consult SMC if the product is used for positive ground environment.

Analogue Output

Flow/Analogue output

	A	B	C
Voltage output	1 V	1.1 V	5 V
Current output	4 mA	4.4 mA	20 mA

Model	Rated flow [l/min]	
	Minimum	Maximum
LFE1	0.5	20
LFE2	2.5	100
LFE3	5	200

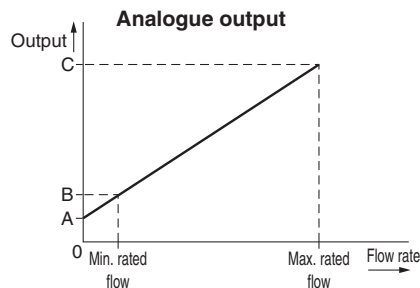

Flow-rate Characteristics (Pressure Loss)

LFE1

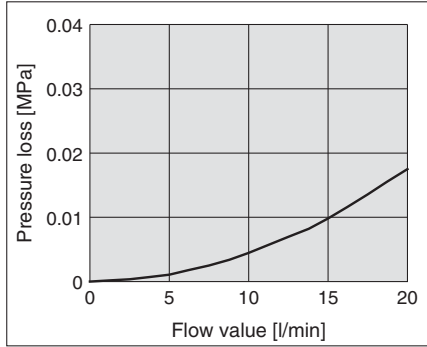

LFE2

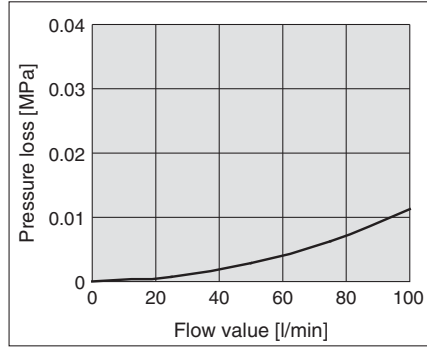

LFE3

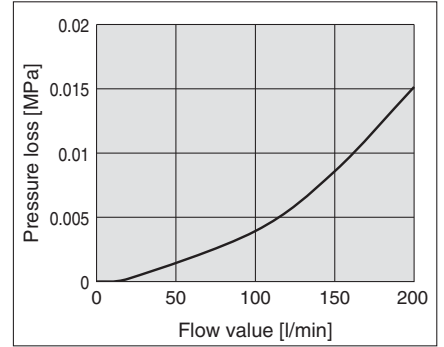

Straight Piping Length and Accuracy (Reference Value)

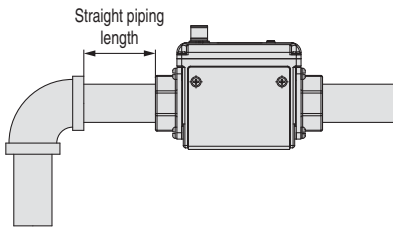

[Measurement conditions]	[Port size]
Fluid: Tap water	LFE1: 3/8 inch
Pressure: 0.2 MPa	LFE2: 3/4 inch
	LFE3: 1 inch

Accuracy change

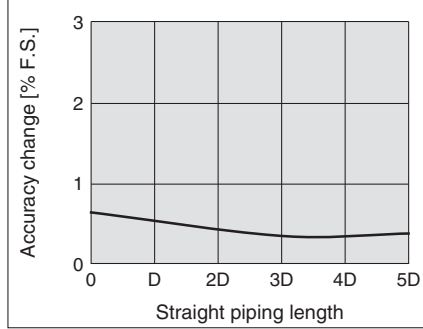

- The smaller the piping size, the more the product is affected by the straight piping length. The straight piping length shall be 5 times (5D) or more of the piping size to achieve the stable measurement.

Model	Straight piping length [mm]	
	D	5D
LFE1	11	55
LFE2	21	105
LFE3	27	135

Stability

- * Stability is improved by increasing the response time setting.
- * Stability indicates the fluctuation width of the display or analogue output.

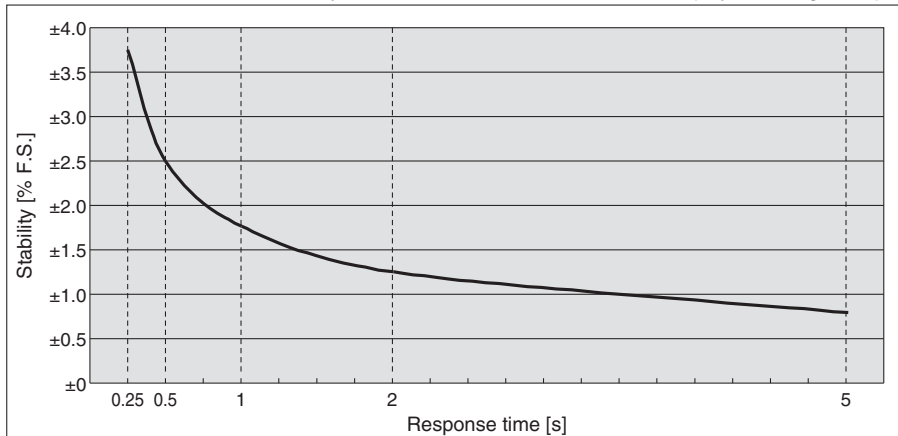

Operating Pressure Range

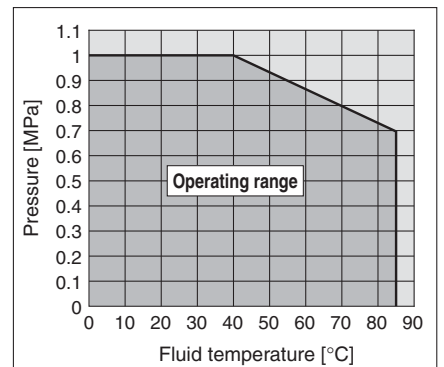

When fluids with high temperature are used, the operating pressure range will be reduced. Operate within the range mentioned above. The proof pressure is double the operating pressure range.

Series LFE

Internal Circuits and Wiring Examples (Integrated Display Type)

NPN 2 outputs type LFE□A□□□

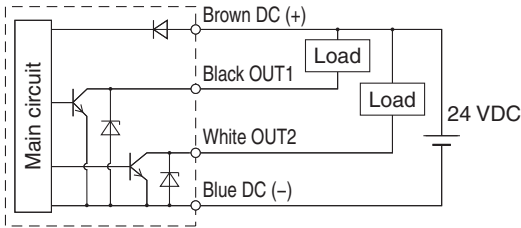

Max. 28 V, 80 mA
Internal voltage drop 1 V or less

PNP 2 outputs type LFE□B□□□

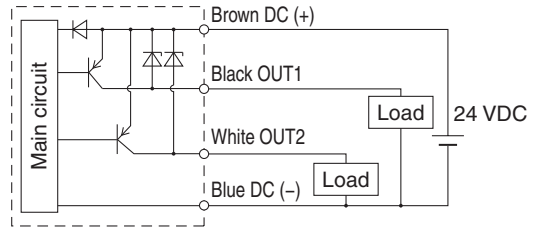

Max. 80 mA
Internal voltage drop 1.5 V or less

NPN + Analogue output type LFE□C□□□

NPN + Analogue output type LFE□D□□□

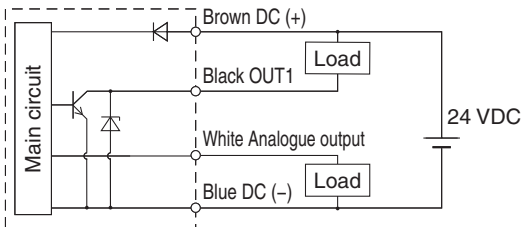

Max. 28 V, 80 mA
Internal voltage drop 1 V or less
C: Analogue output 1 to 5 V
Output impedance 1 kΩ
D: Analogue output 4 to 20 mA
Load impedance 50 to 600 Ω

Accumulated pulse output wiring examples

NPN 2 outputs type LFE□A□□□

NPN + Analogue output type LFE□C□□□/ LFE□D□□□

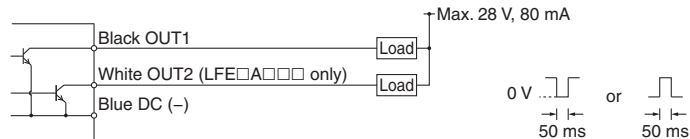

PNP 2 outputs type LFE□B□□□

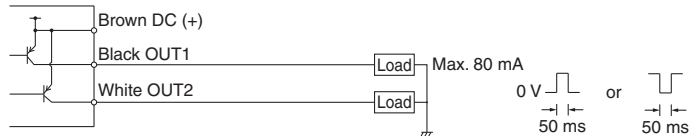

* When accumulated pulse output is selected, the indicator light is turned off.

Internal Circuits and Wiring Examples (Remote Type Sensor Unit)

Analogue output type

LFE□J□□□ (Voltage output type) LFE□K□□□ (Current output type)

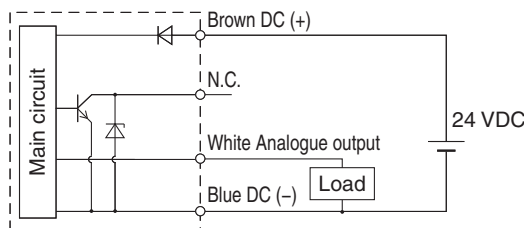

* Do not connect N.C.

Parts Description

Body

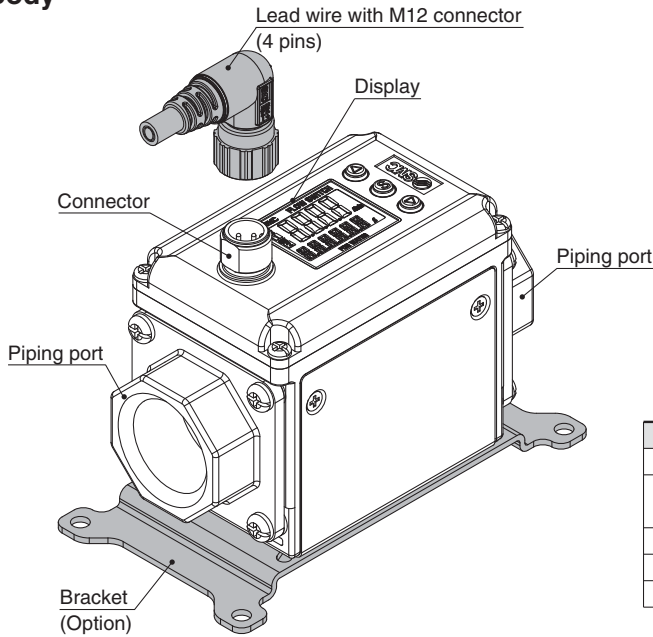

Description	Function
Connector	M12 connector for electrical connections
Lead wire with M12 connector	Cable for supplying power to the product and for receiving output
Piping port	For piping connections
Display	Displays the flow, set values and error information.
Bracket	Mounting bracket for installing the product

Display

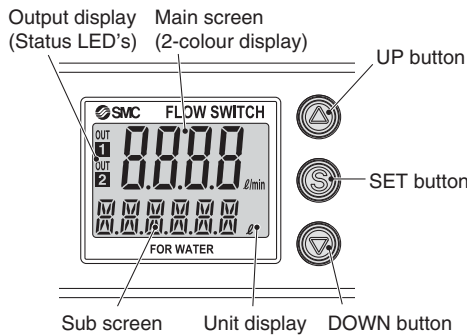

Description	Function
Main screen (2-colour display)	Displays the flow value, setting mode and error codes.
Sub screen	Displays the accumulated flow, set value, peak/bottom value, flow direction and line names. In setting mode, the set status is displayed. (For details, refer to page 13.)
Output display (Status LED's)	Displays the output condition of OUT1 and OUT2. When ON: Orange light turns on.
UP button	Selects the mode and the display shown on the sub screen, or increases the ON/OFF set value.
SET button	Used to make changes in each mode and to enter the set value.
DOWN button	Selects the mode and the display shown on the sub screen, or decreases the ON/OFF set value.
Unit display	Indicates the unit currently selected.

Fluid Passage Structure

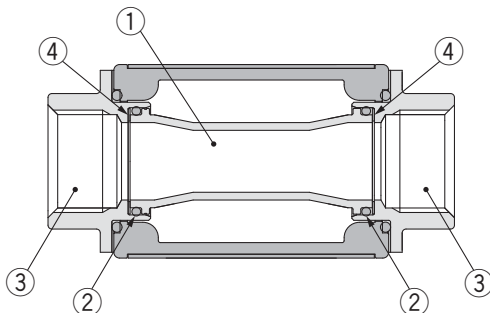

No.	Description	Material
1	Pipe	PPS
2	O-ring	FKM
3	Attachment	C37
4	Spacer	FKM

Series LFE

Dimensions

Integrated display type LFE1/2/3

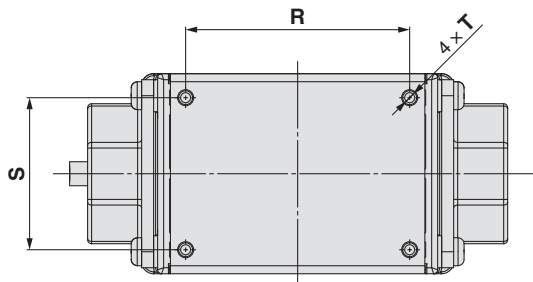

Without bracket (Bottom view)

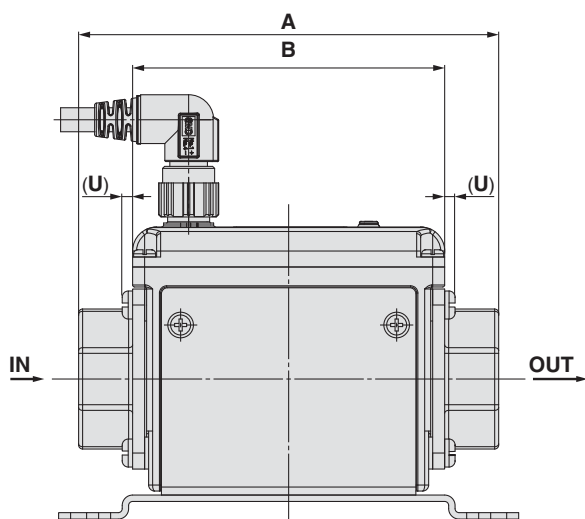

Bracket thickness is approx. 1.6 mm.

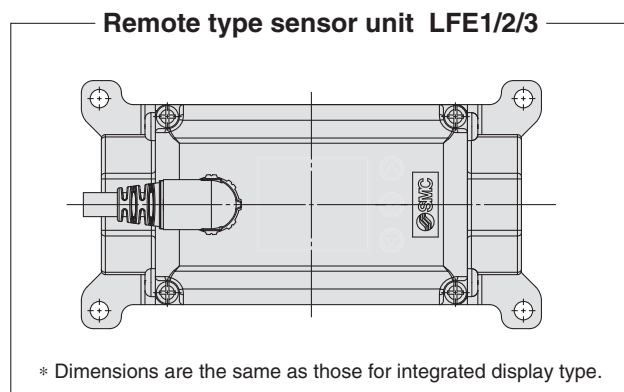
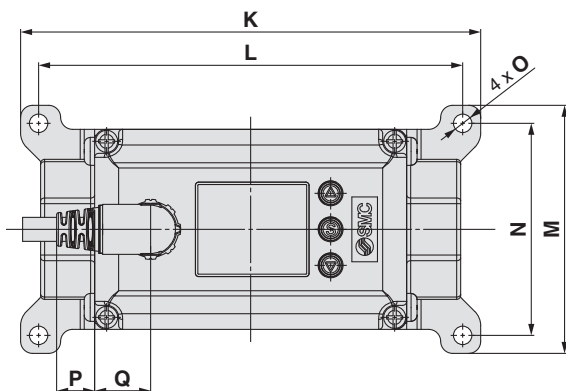

Note) The electrical entry for lead wire with M12 connector does not rotate and is limited to only one entry direction.

* For integrated display type

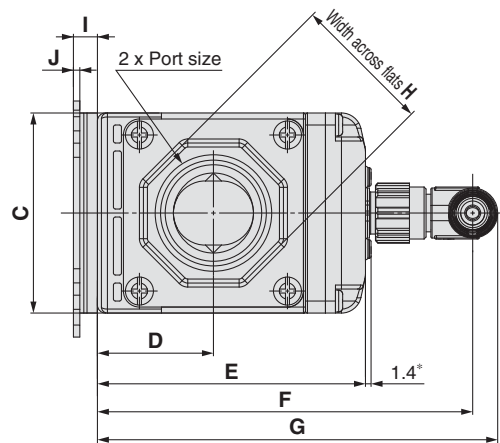

Model	Port size	A	B	C	D	E	F	G	H	I	J	K	L	M	N	O	P	Q	R	S	T	U
LFE1□3□	3/8	90	73	40	23.5	56	83	89	24	6	1.6	96	87	48	39	4.6	12	11.5	52	28	ø 2.5 depth 8.5	2
LFE1□4□	1/2	104	73	40	23.5	56	83	89	28	6	1.6	96	87	48	39	4.6	12	11.5	52	28	ø 2.5 depth 8.5	2
LFE2□	3/4	105	78	50	29	67	94	100	35	6	1.6	115	106	62	53	4.6	9.5	14	56	38	ø 2.5 depth 8.5	2.6
LFE3□	1	120	90	55	32	73	100	106	41	6	1.6	115	106	62	53	4.6	3.5	20	68	43	ø 2.5 depth 8.5	2.6

Note) If you are installing directly, choose the self tapping screw screw-in depth is to 8 mm. Tighten the screw with a torque of 0.7 to 0.8 N·m.

Lead wire with M12 connector

Pin no.	Pin description	Wire colour
1	DC (+)	Brown
2	OUT 2	White
3	DC (-)	Blue
4	OUT 1	Black

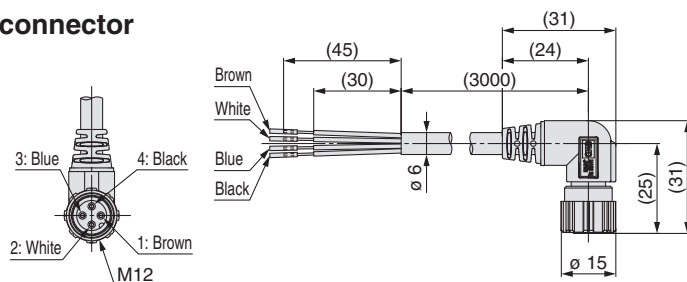

Cable Specifications

Conductor	Nominal cross section area	AWG21
	External diameter	Approx. 0.9 mm
Insulator	Material	Non-lead heat resistant PVC
	External diameter	Approx. 1.7 mm
Sheath	Material	Non-lead heat and oil resistant PVC
	Colours	Brown, White, Black, Blue
Finished external diameter		ø 6

3-colour display

Digital Flow Monitor

Series LFE0



How to Order

LFE0 B - M V C

Type

0 Remote type monitor unit

For remote type sensor unit, select the analogue output 1 to 5 V type.
Applicable sensors: LFE□J□□□

Output specifications

Symbol	OUT1	OUT2
A	NPN	NPN
B	PNP	PNP
C	NPN	Analogue 1 to 5 V
D	NPN	Analogue 4 to 20 mA

Lead wire

With power supply/output connection lead wire (2 m)

N Without power supply/output connection lead wire
Lead wire is not connected, but shipped together.

Remote type monitor unit/Unit specifications

Symbol	Instantaneous flow rate	Accumulated flow
M	l/min	L
G	gal/min	gal

Note) G: Made to Order
Reference: 1 [l/min] ↔ 0.2642 [gal/min]
1 [gal/min] ↔ 3.785 [l/min]

Option 2

Without connector
Sensor connector (1 pc.)

C Connector is not connected, but shipped together.

Option 1

None
Panel mount adapter

T Waterproof seal (Accessory), Panel mount adapter, Mounting screw (M3 x 8L) (Accessory), Panel

Front protective cover + Panel mount adapter
Front protective cover

V Waterproof seal (Accessory), Panel mount adapter, Mounting screw (M3 x 8L) (Accessory), Panel

Option/Part No.

When only optional parts are required, order with the part numbers listed below.

Description	Part no.	Note
Panel mount adapter	ZS-26-B	With waterproof seal, mounting screw
Front protective cover + Panel mount adapter	ZS-26-C	With waterproof seal, mounting screw
Front protective cover only	ZS-26-01	Separately order panel mount adapter etc.
Power supply/output connection lead wire	ZS-40-W	Lead wire length 2 m
Sensor connector (e-con)	ZS-28-C-5	1 pc.
Lead wire with connector for copying	ZS-40-Y	Connect up to 10 slave units

Series LFE0

Specifications

Model	LFE0		
Display flow range	0.4 to 24.0 l/min (Flow under 0.4 l/min is displayed as "0.00")	2.0 to 120.0 l/min (Flow under 2.0 l/min is displayed as "0.0")	4 to 240 l/min (Flow under 4 l/min is displayed as "0.0")
Set flow range	0.4 to 24.0 l/min	2.0 to 120.0 l/min	4 to 240 l/min
Minimum setting unit	0.1 l/min	0.5 l/min	1 l/min
Accumulated volume per pulse	0.1 l/pulse	0.5 l/pulse	1 l/pulse
Display units	Instantaneous flow rate l/min, Accumulated flow L		
Accuracy	Displayed values: $\pm 0.5\%$ F.S., Analogue output: $\pm 0.5\%$ F.S.		
Repeatability	$\pm 0.5\%$ F.S.		
Temperature characteristics	$\pm 0.5\%$ F.S. (25 °C reference)		
Accumulated flow range ^{Note 1)}	9999999.9 L by 0.1 L	99999999 L by 1 L	
Switch output	NPN or PNP open collector output		
Maximum load current	80 mA		
Maximum applied voltage	28 VDC		
Internal voltage drop	NPN: 1 V or less (at load current 80 mA) PNP: 1.5 V or less (at load current 80 mA)		
Response time ^{Note 2)}	0.5 s/1 s/2 s/5 s		
Output protection	Short-circuit protection		
Output mode	Select from hysteresis mode, window comparator mode, accumulated output mode, or accumulated pulse output mode.		
Flow rate Temperature	Select from hysteresis mode or window comparator mode.		
Response time ^{Note 3)}	0.5 s/1 s/2 s/5 s (linked with the switch output)		
Analogue output	Output voltage: 1 to 5 V Output impedance: 1 k Ω		
Voltage output	Output current: 4 to 20 mA Max. load impedance: 300 Ω for 12 VDC, 600 Ω for 24 VDC		
Current output			
Hysteresis	Variable		
Input/output	Input for copy mode		
Display method	2-screen (Main screen: 4-digit, 7-segment, 2-colour, Red/Green; Sub screen: 6-digit, 11-segment, White) Display values updated 5 times per second		
Status LED's	Output 1, Output 2: (Orange)		
Power supply voltage	24 VDC $\pm 10\%$		
Current consumption	50 mA or less		
Connection	Power supply output 5P connector, sensor connection 4P connector (e-con)		
Environmental resistance	Enclosure	IP40 (Only front face of the panel is IP65 when panel mount adapter and waterproof seal of optional parts are used.)	
	Operating temperature range	0 to 50 °C (with no freezing and condensation)	
	Operating humidity range	Operating, Storage: 35 to 85 % R.H. (with no condensation)	
	Withstand voltage	1000 VAC for 1 minute between terminals and housing	
Standards and regulations	Insulation resistance 50 M Ω or more (500 VDC measured via megohmmeter) between terminals and housing CE marking, RoHS		
Weight	Without power supply/output connection lead wire	50 g	
	With power supply/output connection lead wire	100 g	

Note 1) Cleared when the power supply is turned off. Hold function can be selected. (Interval of 2 or 5 minutes can be selected.) If the 5 minutes interval is selected, the life of the memory element (electronic parts) is limited to 1 million cycles. (If energized for 24 hours, life is calculated as 5 minutes x 1 million = 5 million minutes = about 9.5 years.) Therefore, if using the hold function, calculate the memory life for your operating conditions, and use within this life.

Note 2) The response time when the set value is 63 % in relation to the step input.

Note 3) The response time until the set value reaches 63 % in relation to the step input.

Analogue Output

Flow/Analogue output

	A	B	C
Voltage output	1 V	1.1 V	5 V
Current output	4 mA	4.4 mA	20 mA

Connected sensor	Rated flow [l/min]	
	Minimum	Maximum
LFE1	0.5	20
LFE2	2.5	100
LFE3	5	200

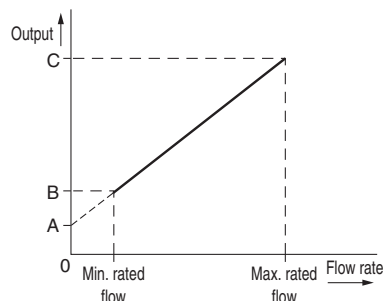

Internal Circuits and Wiring Examples

NPN 2 outputs type LFE0A

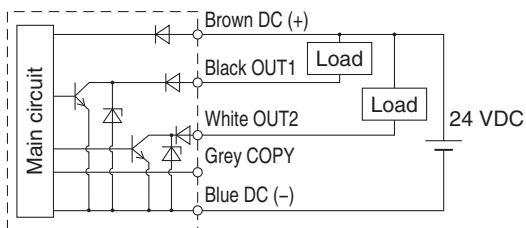

PNP 2 outputs type LFE0B

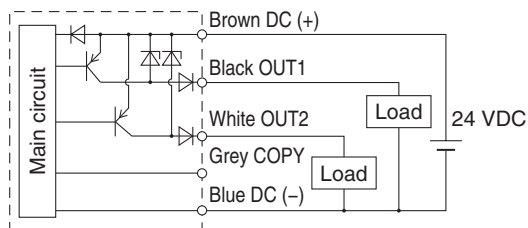

NPN + Analogue output type LFE0C

NPN + Analogue output type LFE0D

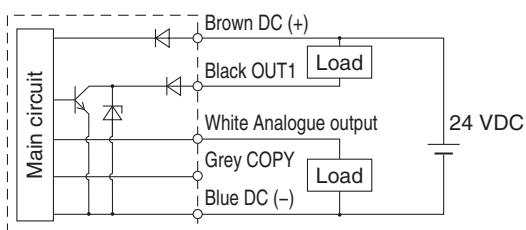

Sensor input circuit

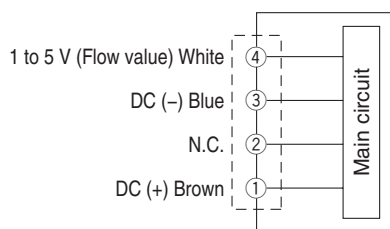

* Do not connect N.C.

Accumulated pulse output wiring examples

NPN 2 outputs type LFE0A

NPN + Analogue output type LFE0C/LFE0D

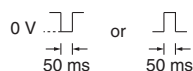
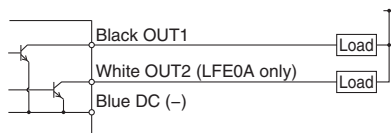

PNP 2 outputs type LFE0B

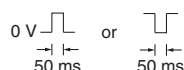
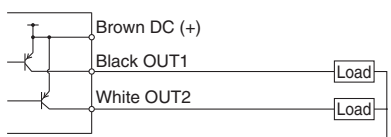

* When accumulated pulse output is selected, the indicator light is turned off.

Series LFE0

Parts Description (Remote Type Monitor Unit)

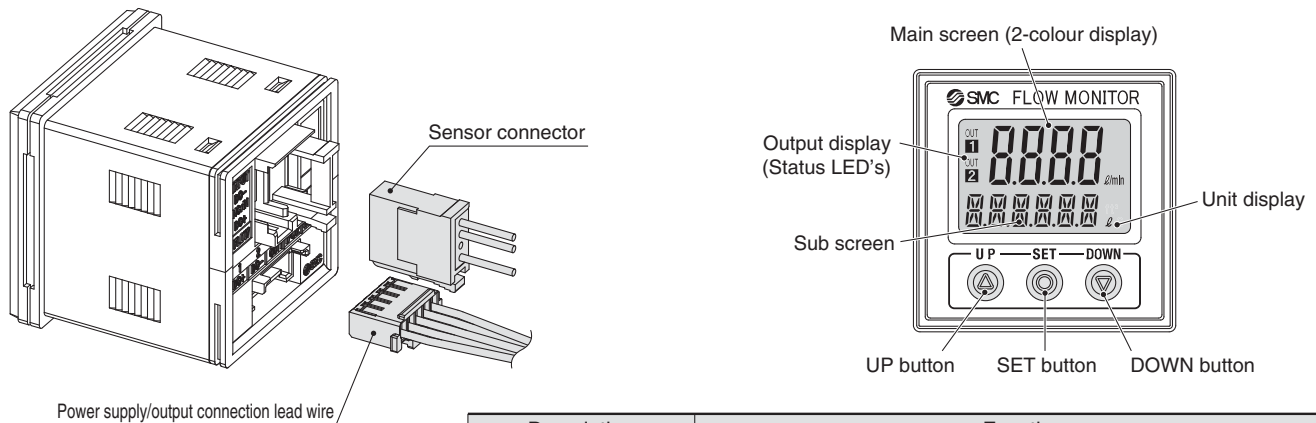

Description	Function
Main screen (2-colour display)	Displays the flow value, setting mode and error codes.
Sub screen	Displays the accumulated flow, set value, peak/bottom value, fluid temperature and line names. In the setting mode, the set status is displayed. (For details, refer to page 13.)
Output display (Status LED's)	Displays the output condition of OUT1 and OUT2. When ON: Orange light turns on.
Unit display	Indicates the unit currently selected.
UP button	Selects the mode and the display shown on the sub screen, or increases the ON/OFF set value.
SET button	Press this button to change the mode and to set a value.
DOWN button	Selects the mode and the display shown on the sub screen, or decreases the ON/OFF set value.

Sensor connector

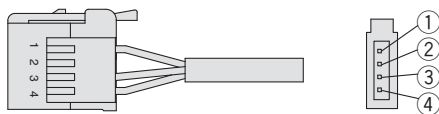

Pin no.	Terminal	Connector no.	Lead wire colour *
①	DC (+)	1	Brown
②	N.C./IN	2	Not used
③	DC (-)	3	Blue
④	INPUT	4	White (Flow sensor 1 to 5 V input)

* When using the lead wire with M12 connector included with the LFE□J series.
Do not connect black.

Power supply/output connection lead wire

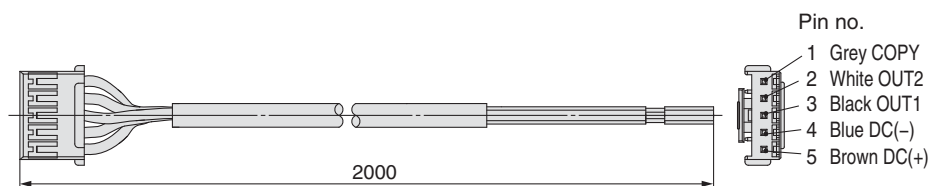

Cable Specifications

Conductor	Nominal cross section area	AWG26
	External diameter	Approx. 0.5 mm
Insulator	Material	Cross-linked vinyl
	External diameter	Approx. 1.0 mm
Colours	Brown, Blue, Black, White, Grey	
Sheath	Material	Oil and heat resistant vinyl
Finished external diameter	ø 3.5	

Dimensions

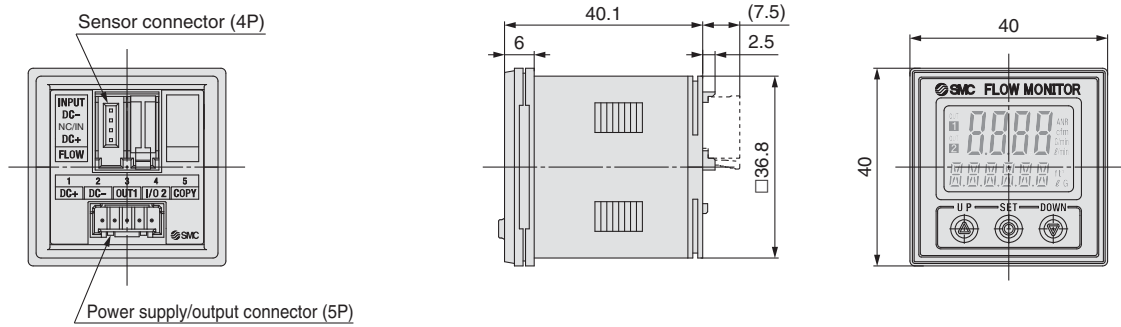

Front protective cover + Panel mount adapter

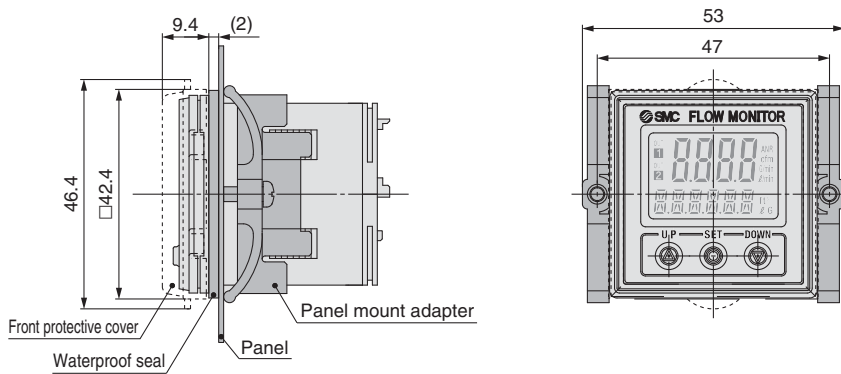

Panel fitting dimensions

Applicable panel thickness:
 0.5 to 8 mm (Without waterproof seal)
 0.5 to 6 mm (With waterproof seal)

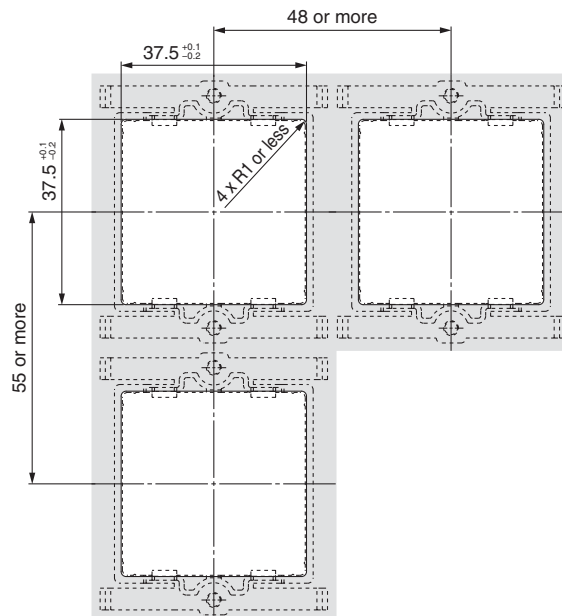

Series LFE

Function Details

Output operation

The output operation can be selected from the following:
Output (hysteresis mode and window comparator mode) corresponding to instantaneous flow rate, output corresponding to accumulated flow, or accumulated pulse output

Note) At the time of shipment from the factory, it is set to hysteresis mode and normal output.

Display colour

The display colour can be selected for each output condition. The selection of the display colour provides visual identification of abnormal values. (The display colour depends on OUT1 setting.)

ON: Green, OFF: Red
ON: Red, OFF: Green
Always: Red
Always: Green

Setting of response time

The response time can be selected depending on the application. (1 second for default setting)
The flickering of the display can be reduced by setting the response time slower. If you need faster detection of the problem such as leakage of tip cooling water for welding gun, switch output or analogue output can be faster by setting the response time faster. In this case, widen the hysteresis to prevent chattering of the switch output.

Response time	Stability
0.25 seconds	±3.7 % F.S.
0.5 seconds	±2.5 % F.S.
1 second	±1.7 % F.S.
2 seconds	±1.2 % F.S.
5 seconds	±0.8 % F.S.

Selection of display on sub screen

The display on the sub screen in measuring mode can be set.

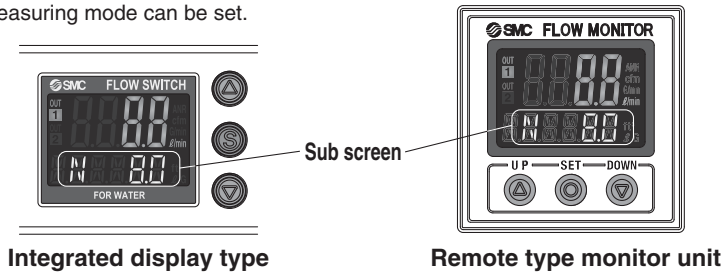

Forced output function

Output is turned ON/OFF compulsorily when starting the system or during maintenance. This enables confirmation of the wiring and prevents system errors due to unexpected output.

For the analogue output type, the output will be 5 V or 20 mA for ON and 1 V or 4 mA for OFF.

* Also, the increase or decrease of the flow will not change the on/off status of the output while the forced output function is activated.

Accumulated value hold function

Accumulated value is not cleared even when the power supply is turned off. The accumulated value is memorized every 2 or 5 minutes during measurement, and continues from the last memorized value when the power supply is turned on again.

The life time of the memory element is 1 million access cycles. Take this into consideration before using this function.

Switching of flow direction

Flow direction can be changed after installation.

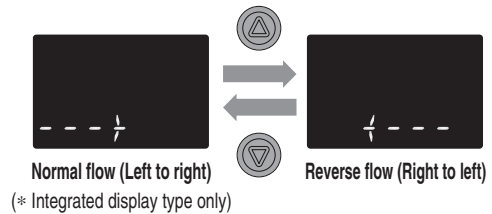

Integrated display type	Remote type monitor unit		
Set value display Displays the set value. (The set value of OUT2 cannot be displayed.) 	Accumulated value display Displays the accumulated value. (The accumulated value of OUT2 cannot be displayed.) 	Peak value display Displays the peak value. 	Bottom value display Displays the bottom value.
Flow direction display Displays the flow direction. (* Integrated display type only) 	Line name display Displays the line name. (Up to 6 alphanumeric characters can be input.) 	Off Displays nothing. 	

■ **Selection of power saving mode**

The display can be turned off to reduce the power consumption (Approx. 10 %). In power saving mode, only decimal points blink. If any button is pressed during power saving mode, the display is recovered for 30 seconds to check the flow etc.

■ **Setting of security code**

Users can select whether a security code must be entered to release key lock. At the time of shipment from the factory, it is set such that the security code is not required.

■ **Peak/Bottom value display**

The maximum (minimum) flow value is detected and updated from when the power supply is turned on. In peak (bottom) value display mode, this maximum (minimum) flow value is displayed.

■ **Keylock function**

Prevents operation errors such as accidentally changing set values.

■ **[F22] Setting of analogue output**

This function can be used only when the optional analogue output is present. The flow value that generates the output voltage (= 5 V) or output current (= 20 mA) at the span side of analogue output can be varied.

<Operation>

Press the or button in function selection mode to display [F22] on the main screen.

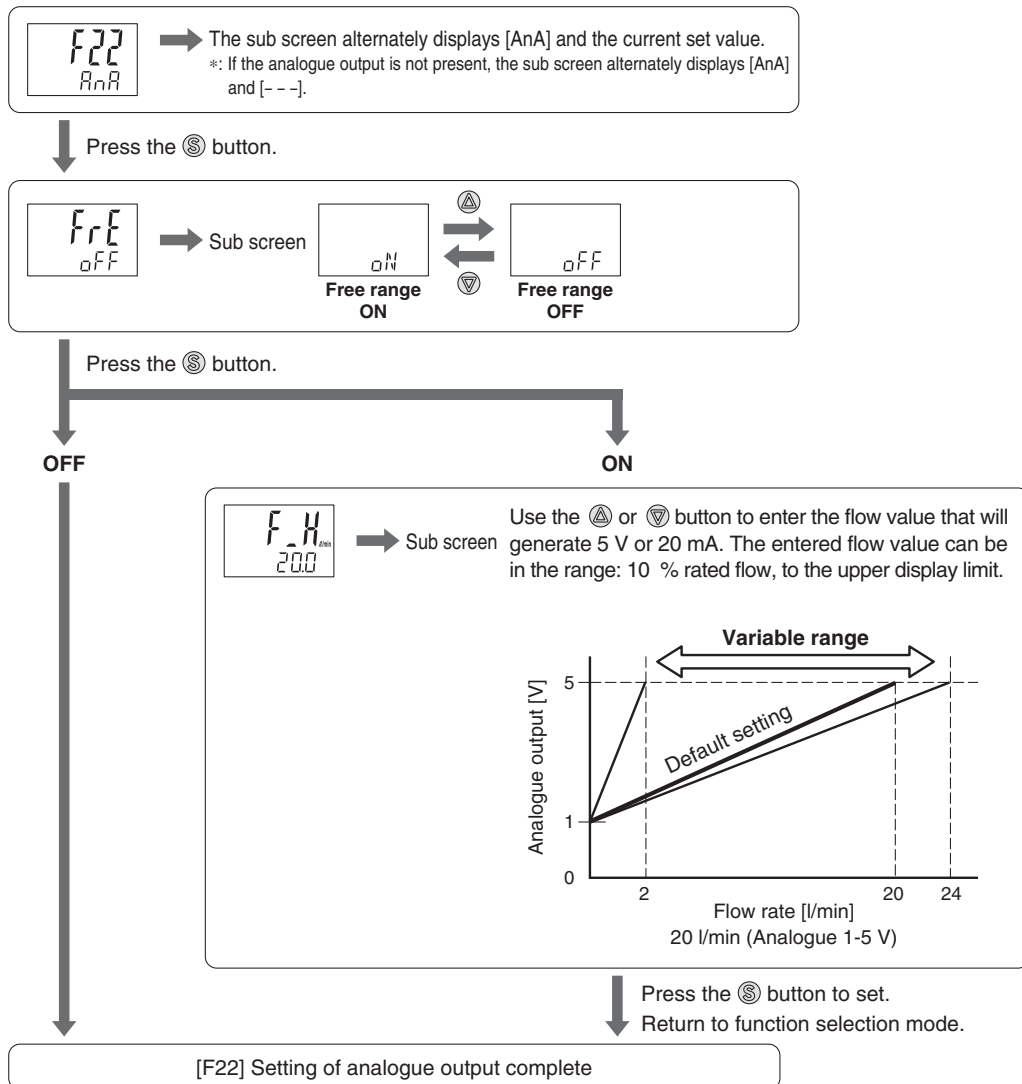

Series LFE

■ Error display function

When a failure or abnormality occurs, the location and contents are displayed.

Display	Description	Contents	Action
Er1	OUT1 over current error	Load current of 80 mA or more is applied to the switch output (OUT1).	Eliminate the cause of the over current by turning off the power supply and then turn it on again.
Er2	OUT2 over current error	Load current of 80 mA or more is applied to the switch output (OUT2).	
HHH	Excessive instantaneous flow rate error	Flow has exceeded the display flow range.	Decrease the flow.
LLL	Reverse flow error	Flow is flowing in the reverse direction of the setting.	Change the setting for the flow direction.
9999999999 (alternately displays [999] and [999999])	Excessive accumulated flow error	Flow has exceeded the accumulated flow range.	Clear the accumulated flow. (This error does not matter when the accumulated flow is not used.)
Er0	System error	Displayed if an internal error has occurred.	Turn off the power supply and then turn it on again. If the failure cannot be solved, please contact SMC for investigation.
Er4			
Er6			
Er8			
Er10	Sensor error	Power supply voltage exceeds 24 V \pm 10 %.	Check the power supply voltage, and turn off the power supply and then turn it on again.



Series LFE

Specific Product Precautions 1

Be sure to read this before handling. Refer to the back cover for Safety Instructions, "Handling Precautions for SMC Products" (M-E03-3) and Operation Manual for Flow Switch Precautions. Please download it via our website, <http://www.smc.eu>

Installation

Warning

1. Since the type of fluid varies depending on the product, be sure to verify the specifications.

The switches do not have an explosion proof rating. To prevent a possible fire hazard, do not use with inflammable gases or fluids.

2. Install the system, so that the fluid always fills the detection passage.

If the product is used when the detection passage is not filled, correct detection signal is not output from the electrodes, making correct measurement impossible. Especially for vertical mounting, introduce the fluid from the bottom to the top because bubbles may be generated when applying fluid from the top to the bottom, leading to operation failure.

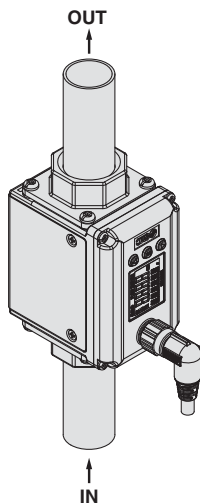

When the product is mounted horizontally, place the display vertical to the floor to prevent bubbles from occurring.

Mounting orientation: ○ Mounting orientation: ×

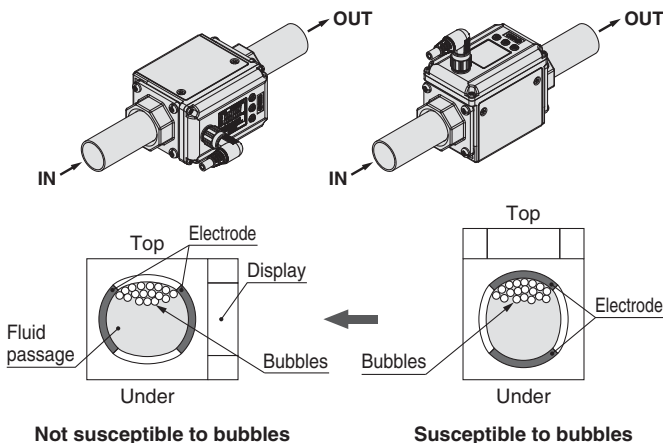

Mounting

Warning

1. Piping port is grounded to DC(-)/blue line.

Do not use the power supply with positive ground.

2. Avoid piping in which the piping size of the IN side of the switch changes suddenly.

If the piping size is reduced sharply or there is a restrictor such as a valve on the IN side, fluid velocity distribution in the piping will be disturbed, leading to improper measurement. Therefore, the above-mentioned piping should be connected on the OUT side.

If the OUT side is opened, or flow rate is excessive, cavitations may be generated, which may result in improper measurement. As a measure against this, it is possible to reduce the cavitations by increasing the fluid pressure. Take action such as mounting an orifice on the OUT side of the switch, and confirm that there is no malfunction before handling. If the orifice of the OUT side is fully closed to operate the pump, the switch may malfunction due to the effect of pulsation (pressure fluctuation). Ensure that there is no malfunction before usage.

3. When multiple sensors are used in parallel, install them outside of the area as shown below. (Uninstallable area) If the product is mounted in the area where installation is prohibited, the accuracy will decrease.

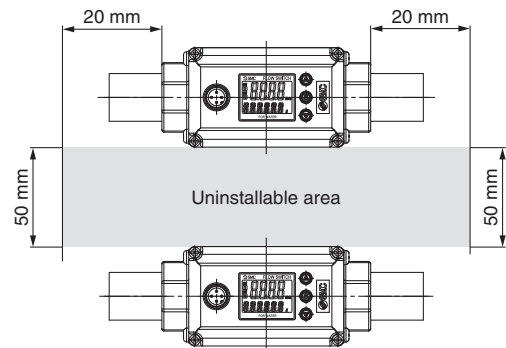

4. Use caution that the electrical entry for lead wire with M12 connector does not rotate and is limited to only one direction.



Series LFE

Specific Product Precautions 2

Be sure to read this before handling. Refer to the back cover for Safety Instructions, "Handling Precautions for SMC Products" (M-E03-3) and Operation Manual for Flow Switch Precautions. Please download it via our website, <http://www.smc.eu>

Mounting

Caution

- When connecting the piping to the switch, do not rotate the switch. Apply a wrench to the metal part of the piping port to turn the fitting.

Using a wrench on other parts may damage the product. Specifically, make sure that the wrench does not damage the M12 connector. This will damage the connector.

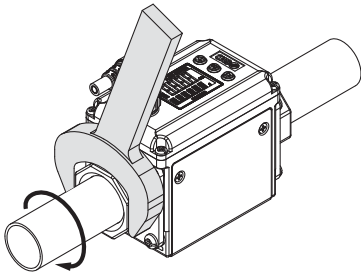

Width across flats of attachment

3/8	24 mm
1/2	28 mm
3/4	35 mm
1	41 mm

Refer to the tightening torque in the right table for connecting steel piping. Torque lower than the value in the table leads to fluid leakage. For mounting the fittings on the market, refer to the torque specified for each.

Nominal thread size	Proper tightening torque (N·m)
Rc (NPT) 3/8	22 to 24
Rc (NPT) 1/2	28 to 30
Rc (NPT) 3/4	28 to 30
Rc (NPT) 1	36 to 38

- The product body is made of resin. Do not impose stress, vibration or impact directly on the product during piping work in order to prevent failure, damage and water leakage.

In particular, never mount a product in a location that will be used as a foothold.

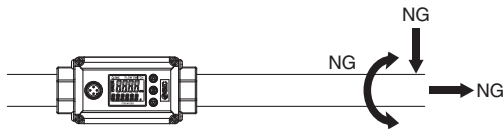

- Secure the front and rear pipes as close to the product as possible in order to prevent stress, vibration and impact from being imposed directly on the product.

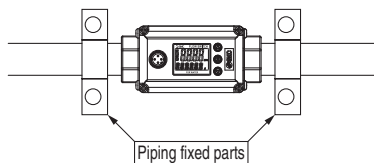

- If stress, vibration and impact imposed on the product cannot be reduced, secure each pipe at multiple positions.

- Inflexible piping such as steel piping tends to be affected by spread of excessive moment load or vibration from the piping side. Lay flexible tubing between the steel pipe and the product to prevent such effects.

In particular, if the piping is off center with the product, load will be imposed on the piping for a long period even after the piping work, possibly resulting in failure, damage or water leakage.

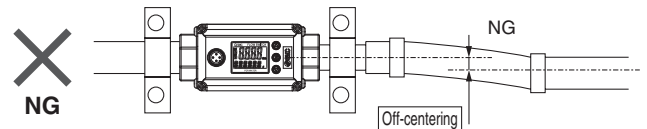
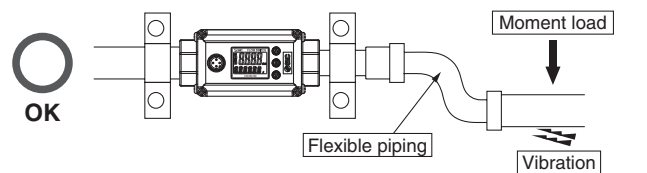

- When using a One-touch fitting, hold the fitting by hand to prevent the load required for connecting or disconnecting the tube from being imposed directly on the product.

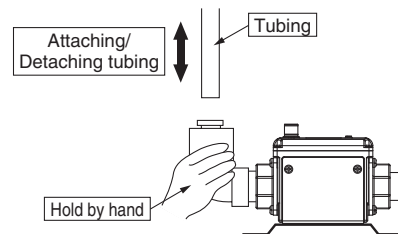

- The straight piping length on the primary side of the product shall be 5 times (5D) or more of the piping size to achieve stable measurement. (Refer to page 4.)
- The operating pressure range and operating temperature range of the product vary depending on the operating conditions. The fluid pressure and temperature should fall within their respective allowable ranges during operation. (Refer to page 4.)



Series LFE

Specific Product Precautions 3

Be sure to read this before handling. Refer to the back cover for Safety Instructions, "Handling Precautions for SMC Products" (M-E03-3) and Operation Manual for Flow Switch Precautions. Please download it via our website, <http://www.smc.eu>

Operating Precautions

Warning

1. Product temperature becomes high when hot fluid is used. Use caution, as there is a danger of being burned if a valve is touched directly.
2. Enclosure is for this product with lead wire with M12 connector. Be careful when handling the product without connector.

Operating Environment

Warning

1. Never use in the presence of explosive gases.
The switch does not have an explosion proof construction. If it is used in an environment where explosive gases are used, it may cause an explosive disaster. Therefore, never use it in such an environment.
2. Observe the specified fluid and ambient temperature range.
The operating fluid temperature range is 0 to 85 °C, and ambient temperature range is 0 to 50 °C. Take measures to prevent moisture from freezing in a piping circuit when using at 5 °C or less, since this may cause damage to the product and lead to malfunction. Even when the ambient temperature range is within the specifications, do not use in locations where there are rapid temperature changes.
3. If the temperature of the fluid is lower than the ambient temperature, condensation will be generated which may damage the product or cause malfunction.

Maintenance

Warning

1. Take precautions when using the switch for an interlock circuit.
When a pressure switch is used for the interlock circuit, devise a multiple interlock system to prevent trouble or malfunction, and verify the operation of the switch and interlock function on a regular basis.

Fluid

Warning

1. Check regulators and flow adjustment valves before introducing the fluid.
If pressure or flow rate beyond the specified range are applied to the switch, the sensor unit may be damaged.

Fluid

Caution

1. Operate fluids with electric conductivity of 5 μS/cm or more.
Note that this product cannot be used for fluids with low conductivity. This product cannot be used for fluids that do not conduct electricity such as deionised water (pure water) and oil.

Applicable Fluids List

Substance description	Judgement	Note
Water	○	Electric conductivity of tap water: 100 to 200 μS/cm
Deionised water (pure water)	×	Electric conductivity is too low.
Water-soluble coolant	○	When the ratio of water is 50 % or more.
Oil	×	Electric conductivity is too low.
Oil-based coolant	×	Electric conductivity is too low.
Sea water	×	Corrosive to the product.
GALDEN®	×	Electric conductivity is too low.
Fluorinert™	×	Electric conductivity is too low.

* Use the applicable fluids list as a guide. ○: Acceptable ×: Not acceptable

The electric conductivity is a ratio which shows how easily the electricity flows.

2. If insulating material gets stuck inside of the piping, it may cause an error.
Remove the foreign material stuck inside of the piping with a brush for washing test tubes so that internal rubber piping will not be damaged.
3. If conductive material such as metal gets stuck to the whole surface in the piping, the switch may malfunction.
Remove the foreign material as mentioned above.
4. If the fluid with stray current running inside is measured, the switch may malfunction.
Beware that earth leakage from the equipment around the switch such as pump and stray current caused by ground fault should not flow into the fluid to be measured.



Series LFE

Specific Product Precautions 4

Be sure to read this before handling. Refer to the back cover for Safety Instructions, "Handling Precautions for SMC Products" (M-E03-3) and Operation Manual for Flow Switch Precautions. Please download it via our website, <http://www.smc.eu>

Others

Warning

1. After the power is turned on, the switch's output remains off while a message is displayed. (Approx. 3 sec.) Therefore, start the measurement after a value is displayed.
2. Perform settings after stopping control systems.
3. Keep the switch away from the strong magnet and magnetic field to prevent the switch from malfunctioning.

Set Flow Range and Rated Flow Range

Caution



Set the flow rate within the rated flow range.

The set flow range is the range of flow rate that is possible in setting.

The rated flow range is the range of flow rate that satisfies the sensor product specifications (such as accuracy, repeatability).



It is possible to set a value outside of the rated flow range if it is within the set flow range, however, the specification is not guaranteed.

Sensor	Flow range							
	0.5 l/min	2 l/min	5 l/min	10 l/min	20 l/min	50 l/min	100 l/min	200 l/min
LFE1	0.5 l/min				20 l/min			
	0.4 l/min				24 l/min			
	0.4 l/min				24 l/min			
LFE2		2.5 l/min					100 l/min	
		2 l/min					120 l/min	
		2 l/min					120 l/min	
LFE3			5 l/min					200 l/min
			4 l/min					240 l/min
			4 l/min					240 l/min

 Rated flow range
 Display flow range
 Set flow range

Safety Instructions

These safety instructions are intended to prevent hazardous situations and/or equipment damage. These instructions indicate the level of potential hazard with the labels of “Caution,” “Warning” or “Danger.” They are all important notes for safety and must be followed in addition to International Standards (ISO/IEC)*1), and other safety regulations.

-  **Caution:** Caution indicates a hazard with a low level of risk which, if not avoided, could result in minor or moderate injury.
-  **Warning:** Warning indicates a hazard with a medium level of risk which, if not avoided, could result in death or serious injury.
-  **Danger:** Danger indicates a hazard with a high level of risk which, if not avoided, will result in death or serious injury.

- *1) ISO 4414: Pneumatic fluid power – General rules relating to systems.
ISO 4413: Hydraulic fluid power – General rules relating to systems.
IEC 60204-1: Safety of machinery – Electrical equipment of machines.
(Part 1: General requirements)
- ISO 10218-1: Manipulating industrial robots - Safety.
etc.

Warning

1. The compatibility of the product is the responsibility of the person who designs the equipment or decides its specifications.

Since the product specified here is used under various operating conditions, its compatibility with specific equipment must be decided by the person who designs the equipment or decides its specifications based on necessary analysis and test results. The expected performance and safety assurance of the equipment will be the responsibility of the person who has determined its compatibility with the product. This person should also continuously review all specifications of the product referring to its latest catalogue information, with a view to giving due consideration to any possibility of equipment failure when configuring the equipment.

2. Only personnel with appropriate training should operate machinery and equipment.

The product specified here may become unsafe if handled incorrectly. The assembly, operation and maintenance of machines or equipment including our products must be performed by an operator who is appropriately trained and experienced.

3. Do not service or attempt to remove product and machinery/equipment until safety is confirmed.

1. The inspection and maintenance of machinery/equipment should only be performed after measures to prevent falling or runaway of the driven objects have been confirmed.
2. When the product is to be removed, confirm that the safety measures as mentioned above are implemented and the power from any appropriate source is cut, and read and understand the specific product precautions of all relevant products carefully.
3. Before machinery/equipment is restarted, take measures to prevent unexpected operation and malfunction.

4. Contact SMC beforehand and take special consideration of safety measures if the product is to be used in any of the following conditions.

1. Conditions and environments outside of the given specifications, or use outdoors or in a place exposed to direct sunlight.
2. Installation on equipment in conjunction with atomic energy, railways, air navigation, space, shipping, vehicles, military, medical treatment, combustion and recreation, or equipment in contact with food and beverages, emergency stop circuits, clutch and brake circuits in press applications, safety equipment or other applications unsuitable for the standard specifications described in the product catalogue.
3. An application which could have negative effects on people, property, or animals requiring special safety analysis.
4. Use in an interlock circuit, which requires the provision of double interlock for possible failure by using a mechanical protective function, and periodical checks to confirm proper operation.

Limited warranty and Disclaimer/ Compliance Requirements

The product used is subject to the following “Limited warranty and Disclaimer” and “Compliance Requirements”.

Read and accept them before using the product.

Limited warranty and Disclaimer

1. The warranty period of the product is 1 year in service or 1.5 years after the product is delivered, whichever is first.*2)
Also, the product may have specified durability, running distance or replacement parts. Please consult your nearest sales branch.
2. For any failure or damage reported within the warranty period which is clearly our responsibility, a replacement product or necessary parts will be provided. This limited warranty applies only to our product independently, and not to any other damage incurred due to the failure of the product.
3. Prior to using SMC products, please read and understand the warranty terms and disclaimers noted in the specified catalogue for the particular products.

*2) Vacuum pads are excluded from this 1 year warranty.

A vacuum pad is a consumable part, so it is warranted for a year after it is delivered.

Also, even within the warranty period, the wear of a product due to the use of the vacuum pad or failure due to the deterioration of rubber material are not covered by the limited warranty.

Compliance Requirements

1. The use of SMC products with production equipment for the manufacture of weapons of mass destruction (WMD) or any other weapon is strictly prohibited.
2. The exports of SMC products or technology from one country to another are governed by the relevant security laws and regulations of the countries involved in the transaction. Prior to the shipment of a SMC product to another country, assure that all local rules governing that export are known and followed.

Caution

1. The product is provided for use in manufacturing industries.

The product herein described is basically provided for peaceful use in manufacturing industries.

If considering using the product in other industries, consult SMC beforehand and exchange specifications or a contract if necessary.

If anything is unclear, contact your nearest sales branch.

Caution

SMC products are not intended for use as instruments for legal metrology.

Measurement instruments that SMC manufactures or sells have not been qualified by type approval tests relevant to the metrology (measurement) laws of each country.

Therefore, SMC products cannot be used for business or certification ordained by the metrology (measurement) laws of each country.

Safety Instructions

Be sure to read “Handling Precautions for SMC Products” (M-E03-3) before using.

SMC Corporation (Europe)

Austria	☎ +43 (0)2262622800	www.smc.at	office@smc.at	Lithuania	☎ +370 5 2308118	www.smclt.lt	info@smclt.lt
Belgium	☎ +32 (0)33551464	www.smcpn pneumatics.be	info@smcpneumatics.be	Netherlands	☎ +31 (0)205318888	www.smcpn pneumatics.nl	info@smcpneumatics.nl
Bulgaria	☎ +359 (0)2807670	www.smc.bg	office@smc.bg	Norway	☎ +47 67129020	www.smc-norge.no	post@smc-norge.no
Croatia	☎ +385 (0)13707288	www.smc.hr	office@smc.hr	Poland	☎ +48 222119600	www.smc.pl	office@smc.pl
Czech Republic	☎ +420 541424611	www.smc.cz	office@smc.cz	Portugal	☎ +351 226166570	www.smc.eu	postpt@smc.smces.es
Denmark	☎ +45 70252900	www.smcdk.com	smc@smcdk.com	Romania	☎ +40 213205111	www.smcromania.ro	smcromania@smcromania.ro
Estonia	☎ +372 6510370	www.smcpn pneumatics.ee	smc@smcpneumatics.ee	Russia	☎ +7 8127185445	www.smc-pneumatik.ru	info@smc-pneumatik.ru
Finland	☎ +358 207513513	www.smc.fi	smc@smc.fi	Slovakia	☎ +421 (0)413213212	www.smc.sk	office@smc.sk
France	☎ +33 (0)164761000	www.smc-france.fr	info@smc-france.fr	Slovenia	☎ +386 (0)73885412	www.smc.si	office@smc.si
Germany	☎ +49 (0)61034020	www.smc.de	info@smc.de	Spain	☎ +34 902184100	www.smc.eu	post@smc.smces.es
Greece	☎ +30 210 2717265	www.smchellas.gr	sales@smchellas.gr	Sweden	☎ +46 (0)86031200	www.smc.nu	post@smc.nu
Hungary	☎ +36 23511390	www.smc.hu	office@smc.hu	Switzerland	☎ +41 (0)523963131	www.smc.ch	info@smc.ch
Ireland	☎ +353 (0)14039000	www.smcpn pneumatics.ie	sales@smcpneumatics.ie	Turkey	☎ +90 212 489 0 440	www.smcpnomatik.com.tr	info@smcpnomatik.com.tr
Italy	☎ +39 0292711	www.smcitalia.it	mailbox@smcitalia.it	UK	☎ +44 (0)845 121 5122	www.smcpn pneumatics.co.uk	sales@smcpneumatics.co.uk
Latvia	☎ +371 67817700	www.smc.lv	info@smclv.lv				

SMC CORPORATION Akihbara UDX 15F, 4-14-1, Sotokanda, Chiyoda-ku, Tokyo 101-0021, JAPAN Phone: 03-5207-8249 FAX: 03-5298-5362