

CKT NO	PART NO	DIM A
2	170001-0102	8.35
4	170001-0104	12.05
6	170001-0106	17.75
8	170001-0108	23.45 <sup>+0.40</sup> <sub>-0.25</sub>
10	170001-0110	29.15 <sup>+0.40</sup> <sub>-0.25</sub>
12	170001-0112	34.85 <sup>+0.40</sup> <sub>-0.25</sub>

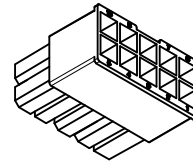

170001-0110

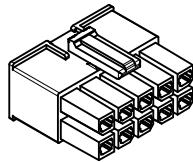
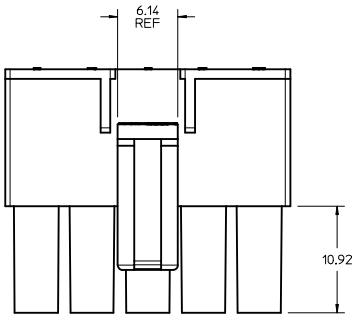
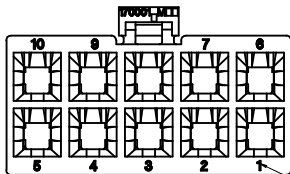
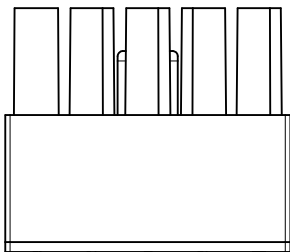
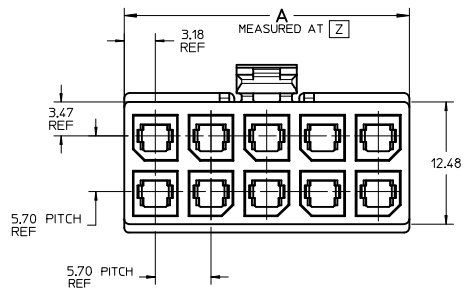
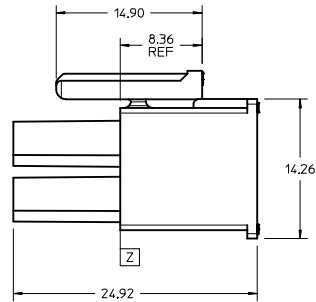

CIRCUIT #

NOTES:

1. MATERIAL:  
HOUSING: NYLON, UL94V-2, GLOW WIRE CAPABLE PER IEC-60335-1 5TH EDITION, COLOR: BLACK.
2. FINISH: NOT APPLICABLE.
3. PRODUCT SPECIFICATION PS-76823-100.
4. PACKAGING BULK PACK PER PK-170001-001.
5. PART MATES WITH MOLEX SERIES NUMBER 76825, 172064, 76829 AND 172065.
6. PART IS FOR USE WITH MOLEX FEMALE TERMINALS 76823 OR 172063 SERIES.
7. APPLICATION SPECIFICATION: AS-76823-100.
8. PARTS CONFORM TO CLASS 'B' REQUIREMENTS OF COSMETIC SPECIFICATION PS-45499-002 WITH THE EXCEPTION OF DISCOLORATION MEETS CLASS 'C' REQUIREMENTS.

REVISE RIBS IEC NO: UCP2015-2016 2015/01/09 DRAWN: BELL 2015/01/09 CHKD: BELL 2015/03/10 APPR: F. SMITH 2015/03/10	QUALITY SYMBOLS ∇=0 ∇=0 ∇=0	GENERAL TOLERANCES (UNLESS SPECIFIED): mm INCH		DIMENSION STYLE MM ONLY		SCALE 4:1	DESIGN UNITS METRIC	THIRD ANGLE PROJECTION
		4 PLACES ±--- ±--- 3 PLACES ±--- ±--- 2 PLACES ±0.25 ±--- 1 PLACE ±--- ±--- 0 PLACE ± ±	DRAWN BY MKARADIMAS DATE 2010/11/23	CHECKED BY DATE	TITLE MEGA-FIT RECEPTACLE HOUSING 2-12 CKT GLOW WIRE			APPROVED BY APATEL DATE 2012/06/13
DRAFT WHERE APPLICABLE MUST REMAIN WITHIN DIMENSIONS		ANGULAR ±1/2°		SIZE D THIS DRAWING CONTAINS INFORMATION THAT IS PROPRIETARY TO MOLEX INCORPORATED AND SHOULD NOT BE USED WITHOUT WRITTEN PERMISSION		SHEET NO. 1 OF 2		

20 19 18 17 16 15 14 13 12 11 10 9 8 7 6 5 4 3 2 1

2 CKTS

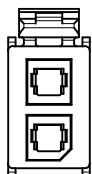

4 CKT

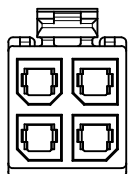

6 CKT

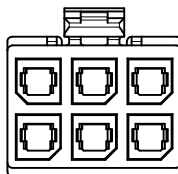

8 CKT

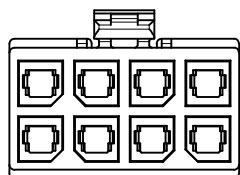

10 CKTS

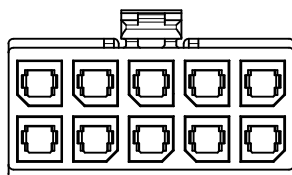

12 CKTS

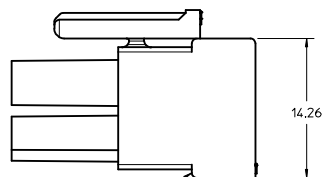
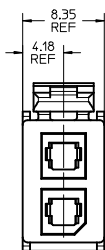
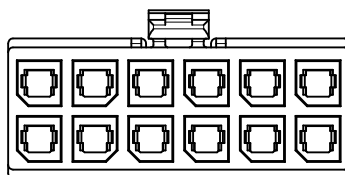

BOTTOM RIBS  
ON 2 CKT ONLY

170001-0102

SEE SHT 1 IEC NO: UCP2015-2016 DRAWN: BELL 2015/01/09 CHECKED: BELL 2015/01/09 APPR: FSW TH 2015/03/10 REV DESCRIPTION	QUALITY SYMBOLS	GENERAL TOLERANCES (UNLESS SPECIFIED)	DIMENSION STYLE	SCALE	DESIGN UNITS	THIRD ANGLE PROJECTION
	▽=0	4 PLACES ± mm ± INCH	MM ONLY	4:1	METRIC	☉
	▽=0	3 PLACES ± 0.25				
	▽=0	2 PLACES ±				
		ANGULAR ±1/2°				
		DRAFT WHERE APPLICABLE MUST REMAIN WITHIN DIMENSIONS				
			MATERIAL NO.	APPROVED BY	DATE	TITLE
			SEE CHART	APATEL	2012/06/13	MEGA-FIT RECEPTACLE HOUSING 2-12 CKT GLOW WIRE
						<b>molex</b>
						DOCUMENT NO. SD-170001-0100
						SHEET NO. 2 OF 2
						THIS DRAWING CONTAINS INFORMATION THAT IS PROPRIETARY TO MOLEX INCORPORATED AND SHOULD NOT BE USED WITHOUT WRITTEN PERMISSION

19 18 17 16 15 14 13 12 11 10 9 8 7 6 5 4 3 2 1

CKT NO	PART NO	DIM A
2	171692-0102	8.35
4	171692-0104	12.05
6	171692-0106	17.75
8	171692-0108	23.45 +0.40
10	171692-0110	29.15 +0.40
12	171692-0112	34.85 +0.40

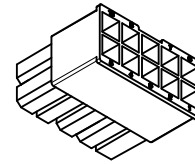
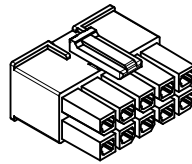
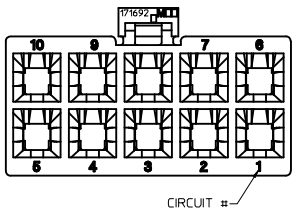
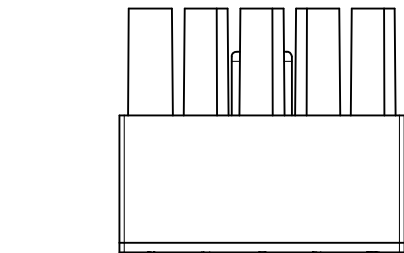
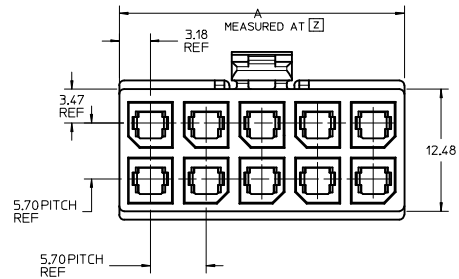
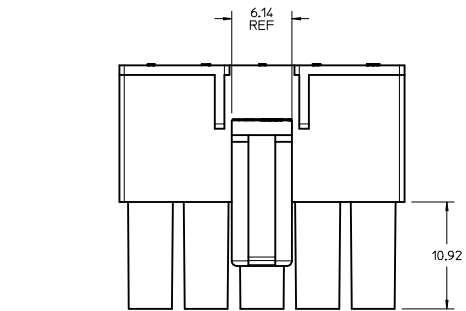

171692-0110

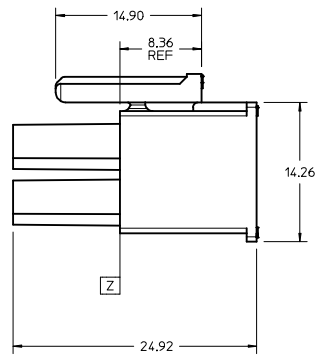

NOTES:

- MATERIAL:  
HOUSING: PBT, UL 94V-0, COLOR: BLACK.
- FINISH: NOT APPLICABLE.
- PRODUCT SPECIFICATION: PS-76823-100.
- PACKAGING: BULK PACK PER PK-170001-001
- PART MATES WITH MOLEX SERIES NUMBERS 76825, 76829, 172064, AND 172065.
- PART IS FOR USE WITH MOLEX FEMALE TERMINAL 76823 OR 172063 SERIES.
- APPLICATION SPECIFICATION: AS-76823-100.
- PARTS CONFORM TO CLASS B REQUIREMENTS OF COSMETIC SPECIFICATION PS-45499-002 WITH THE EXCEPTION OF DISCOLORATION MEETS CLASS "C" REQUIREMENTS.

REVISE RIBS EEC NO: UCP2015-2016 DRAWN: BELL 2015/01/09 CHKD: BELL 2015/01/09 APPR: F SMITH 2015/03/10	QUALITY SYMBOLS ∇=0 ∇=0 ∇=0	GENERAL TOLERANCES (UNLESS SPECIFIED): mm INCH		DIMENSION STYLE MM ONLY		SCALE 4:1	DESIGN UNITS METRIC	THIRD ANGLE PROJECTION
		4 PLACES ±--- ±--- 3 PLACES ±--- ±--- 2 PLACES ±0.25 ±--- 1 PLACE ±--- ±--- 0 PLACE ±--- ±---	DRAWN BY MKARADIMAS DATE 2012/08/01	CHECKED BY A. PATEL DATE 2012/08/17	TITLE MEGA-FIT RECEPTACLE HOUSING 2-12 CKT			
MATERIAL NO. SEE CHART		DOCUMENT NO. SD-171692-0100		SHEET NO. 1 OF 2				
THIS DRAWING CONTAINS INFORMATION THAT IS PROPRIETARY TO MOLEX INCORPORATED AND SHOULD NOT BE USED WITHOUT WRITTEN PERMISSION								

20 19 18 17 16 15 14 13 12 11 10 9 8 7 6 5 4 3 2 1

2 CKTS

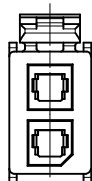

4 CKT

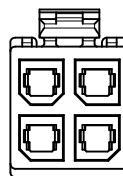

6 CKT

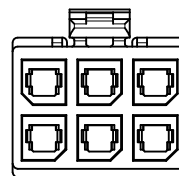

8 CKT

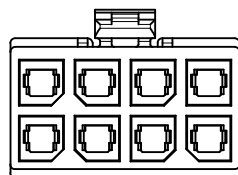

10 CKTS

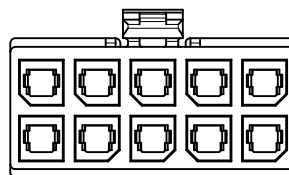

12 CKTS

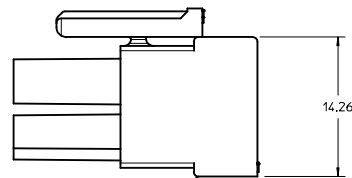
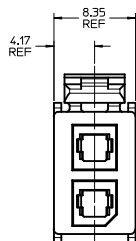
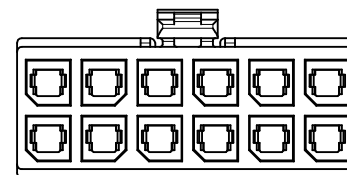

BOTTOM RIB ON  
2 CKT ONLY

171692-0102

SEE SHT 1 IEC NO: UCP2015-2016 DRAWN: J.BELL 2015/01/09 CHECKED: J.BELL 2015/01/09 APPROVED: F.S.MITH 2015/03/10	QUALITY SYMBOLS ∇=0 ∇=0 ∇=0	GENERAL TOLERANCES (UNLESS SPECIFIED)		DIMENSION STYLE <b>MM ONLY</b>	SCALE <b>4:1</b>	DESIGN UNITS <b>METRIC</b>	THIRD ANGLE PROJECTION		
		4 PLACES ±--- ±---	3 PLACES ±--- ±---	2 PLACES ±0.25 ±---	1 PLACE ±--- ±---	0 PLACE ±--- ±---	DRAWN BY MKARADIMAS	DATE 2012/08/01	TITLE MEGA-FIT RECEPTACLE HOUSING 2-12 CKT
		ANGULAR ±1/2°		DRAFT WHERE APPLICABLE MUST REMAIN WITHIN DIMENSIONS		MATERIAL NO. <b>SEE CHART</b>	APPROVED BY APATEL	DATE 2012/08/17	DOCUMENT NO. SD-171692-0100
		SIZE D		THIS DRAWING CONTAINS INFORMATION THAT IS PROPRIETARY TO MOLEX INCORPORATED AND SHOULD NOT BE USED WITHOUT WRITTEN PERMISSION		SHEET NO. 2 OF 2			

19 18 17 16 15 14 13 12 11 10 9 8 7 6 5 4 3 2 1