

---

## Description

---

The AP3503 is a 340kHz fixed frequency, current mode, PWM synchronous buck (step-down) DC-DC converter, capable of driving a 3A load with high efficiency, excellent line and load regulation. The device integrates N-channel power MOSFET switches with low on-resistance. Current mode control provides fast transient response and cycle-by-cycle current limit.

The AP3503 employs complete protection to ensure system security. Including output Over Voltage Protection, input Under Voltage LockOut, programmable soft-start, Over Temperature Protection to safeguard the circuit.

This IC is available in PSOP-8 package.

---

## Features

---

- Input Voltage Range: 4.5V to 18V
- Fixed 340kHz Frequency
- High Efficiency: up to 95%
- Output Current: 3A
- Current Mode Control
- Built-In Over Current Protection
- Built-In Thermal Shutdown Function
- Built-In UVLO Function
- Built-In Over Voltage Protection
- Programmable Soft-start

---

## Pin Assignments

---

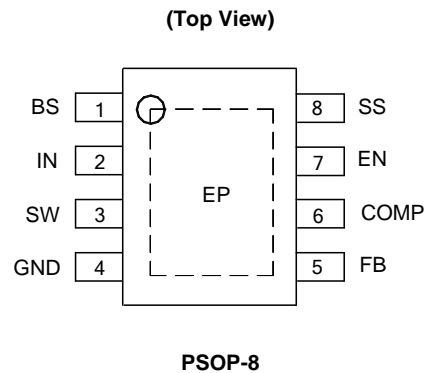

---

## Applications

---

- LCD TV
- Set Top Box
- Portable DVD
- Digital Photo Frame

## Typical Applications Circuit

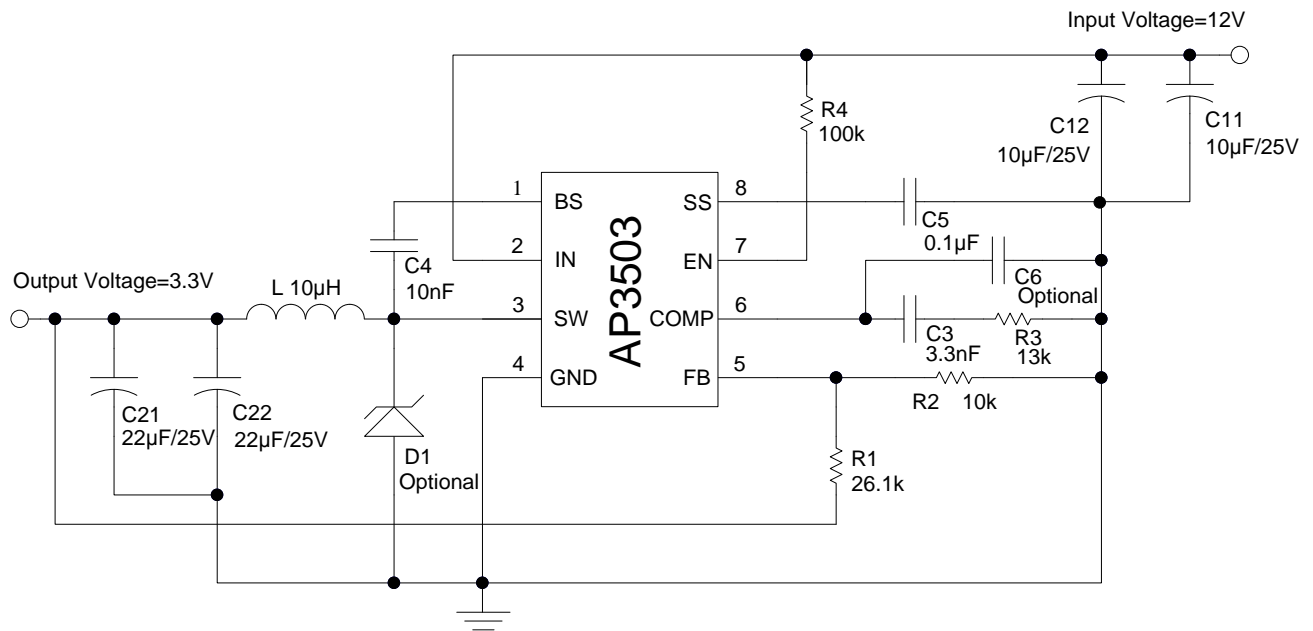

## Pin Descriptions

Pin Number	Pin Name	Function
1	BS	Bootstrap pin. A bootstrap capacitor is connected between the BS pin and SW pin. The voltage across the bootstrap capacitor drives the internal high-side power MOSFET
2	IN	Supply power input pin. A capacitor should be connected between the IN pin and GND pin to keep the input voltage constant
3	SW	Power switch output pin. This pin is connected to the inductor and bootstrap capacitor
4	GND	Ground pin
5	FB	Feedback pin. This pin is connected to an external resistor divider to program the system output voltage. When the FB pin voltage exceeds 1.1V, the over voltage protection is triggered. When the FB pin voltage is below 0.3V, the oscillator frequency is lowered to realize short circuit protection
6	COMP	Compensation pin. This pin is the output of the transconductance error amplifier and the input to the current comparator. It is used to compensate the control loop. Connect a series RC network from this pin to GND. In some cases, an additional capacitor from this pin to GND pin is required
7	EN	Control input pin. EN is a digital input that turns the regulator on or off. Drive EN high/low to turn on/off the regulator. Pull up with 100kΩ resistor for automatic startup
8	SS	Soft-start control input pin. SS controls the soft-start period. Connect a capacitor from SS to GND to set the soft-start period. A 0.1µF capacitor sets the soft-start period to 15ms. To disable the soft-start feature, leave SS unconnected
	EP	Exposed pad. It should be connected to GND in PCB layout

**Functional Block Diagram**

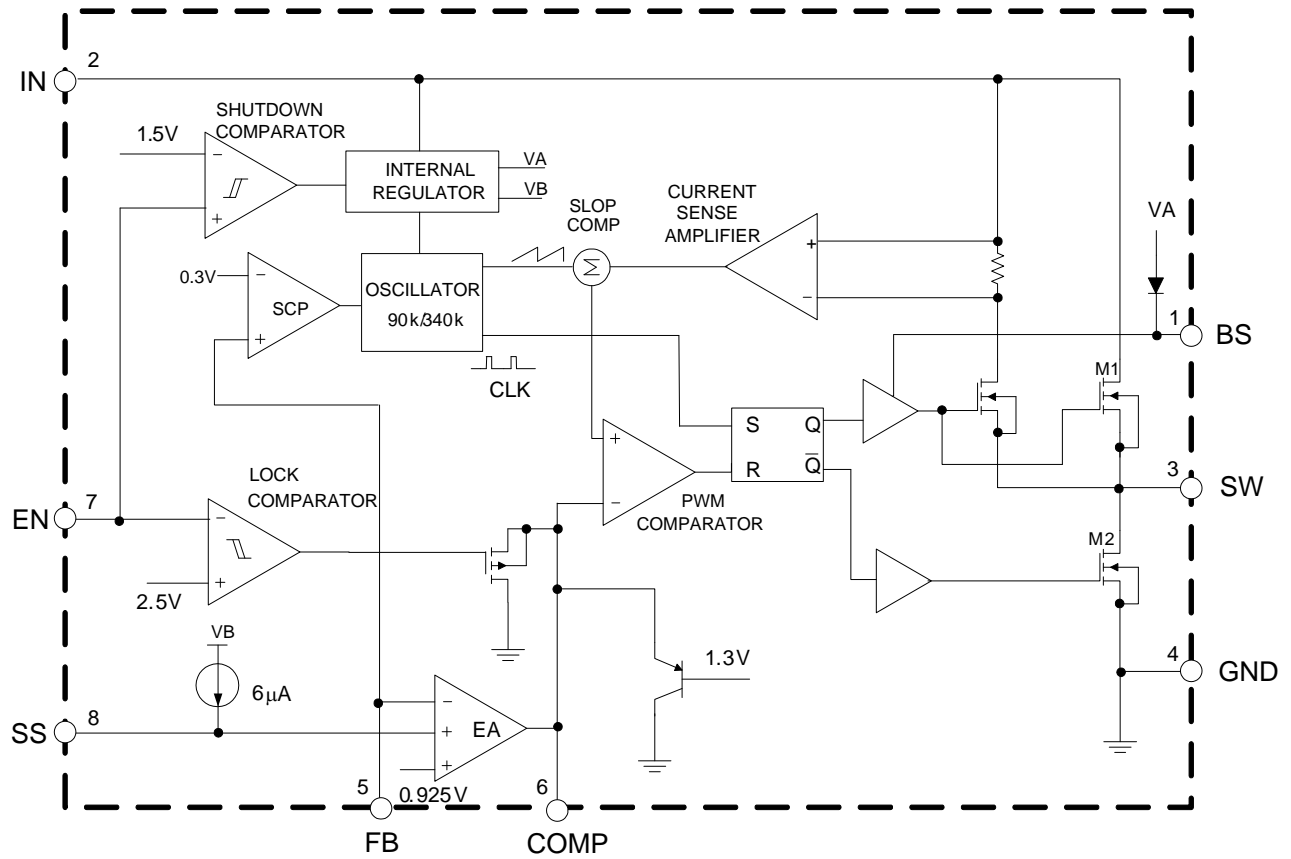

## Absolute Maximum Ratings (Note 1)

Symbol	Parameter	Value	Unit
$V_{IN}$	IN Pin Voltage	-0.3 to 20	V
$V_{EN}$	EN Pin Voltage	-0.3 to $V_{IN}$	V
$V_{SW}$	SW Pin Voltage	21	V
$V_{BS}$	BS Pin Voltage	-0.3 to $V_{SW}+6$	V
$V_{FB}$	FB Pin Voltage	-0.3 to 6	V
$V_{COMP}$	COMP Pin Voltage	-0.3 to 6	V
$V_{SS}$	SS Pin Voltage	-0.3 to 6	V
$\theta_{JA}$	Thermal Resistance	60	°C/W
$T_J$	Operating Junction Temperature	+150	°C
$T_{STG}$	Storage Temperature	-65 to +150	°C
$T_{LEAD}$	Lead Temperature (Soldering, 10sec)	+260	°C
$V_{HBM}$	ESD (Human Body Model)	2000	V
$V_{MM}$	ESD (Machine Model)	200	V

Note 1: Stresses greater than those listed under "Absolute Maximum Ratings" may cause permanent damage to the device. These are stress ratings only, and functional operation of the device at these or any other conditions beyond those indicated under "Recommended Operating Conditions" is not implied. Exposure to "Absolute Maximum Ratings" for extended periods may affect device reliability.

## Recommended Operating Conditions

Symbol	Parameter	Min	Max	Unit
$V_{IN}$	Input Voltage	4.5	18	V
$T_A$	Operating Ambient Temperature	-40	+85	°C

**Electrical Characteristics** ( $T_A=+25^{\circ}\text{C}$ ,  $V_{IN}=V_{EN}=12\text{V}$ ,  $V_{OUT}=3.3\text{V}$ , unless otherwise specified.)

Symbol	Parameter	Conditions	Min	Typ	Max	Unit
<b>SUPPLY VOLTAGE (IN PIN)</b>						
$V_{IN}$	Input Voltage	–	4.5	–	18	V
$I_Q$	Quiescent Current	$V_{FB}=1\text{V}, V_{EN}=3\text{V}$	–	1.2	1.4	mA
$I_{SHDN}$	Shutdown Supply Current	$V_{EN}=0\text{V}$	–	0.1	10	$\mu\text{A}$
<b>UNDER VOLTAGE LOCKOUT</b>						
$V_{UVLO}$	Input UVLO Threshold	$V_{IN}$ Rising	3.65	4.00	4.25	V
$V_{HYS}$	Input UVLO Hysteresis	–	–	200	–	mV
<b>ENABLE (EN PIN)</b>						
–	EN Shutdown Threshold Voltage	–	1.1	1.5	2	V
–	EN Shutdown Threshold Voltage Hysteresis (Note 2)	–	–	350	–	mV
–	EN Lockout Threshold Voltage	–	2.2	2.5	2.7	V
–	EN Lockout Hysteresis	–	–	210	–	mV
<b>VOLTAGE REFERENCE (FB PIN)</b>						
$V_{FB}$	Feedback Voltage	–	0.907	0.925	0.943	V
$V_{FBOV}$	Feedback Over Voltage Threshold	–	–	1.1	–	V
$I_{FB}$	Feedback Bias Current	$V_{FB}=1\text{V}$	-0.1	–	0.1	$\mu\text{A}$
<b>MOSFET</b>						
$R_{DS(ON)H}$	High-side Switch On-resistance (Note 3)	$I_{SW}=0.2\text{A}/0.7\text{A}$	–	100	–	m $\Omega$
$R_{DS(ON)L}$	Low-side Switch On-resistance (Note 3)	$I_{SW}=-0.2\text{A}/-0.7\text{A}$	–	100	–	m $\Omega$
<b>CURRENT LIMIT</b>						
$I_{LEAKH}$	High-side Switch Leakage Current	$V_{IN}=18\text{V}, V_{EN}=V_{SW}=0\text{V}$	–	0.1	10	$\mu\text{A}$
$I_{LIMH}$	High-side Switch Current Limit	–	4.3	5.6	–	A
$I_{LIML}$	Low-side Switch Current Limit	From drain to Source	–	1.4	–	A
<b>SWITCHING REGULATOR</b>						
$f_{OSC1}$	Oscillator Frequency	–	280	340	400	kHz
$f_{OSC2}$	Short Circuit Oscillator Frequency	–	–	90	–	kHz
$D_{MAX}$	Max. Duty Cycle	$V_{FB}=0.85\text{V}$	–	90	–	%
$D_{MIN}$	Min. Duty Cycle	$V_{FB}=1\text{V}$	–	–	0	%

**Electrical Characteristics** (Cont.  $T_A=+25^{\circ}\text{C}$ ,  $V_{IN}=V_{EN}=12\text{V}$ ,  $V_{OUT}=3.3\text{V}$ , unless otherwise specified.)

Symbol	Parameter	Conditions	Min	Typ	Max	Unit
<b>ERROR AMPLIFIER</b>						
$A_{EA}$	Error Amplifier Voltage Gain (Note 2)	–	–	400	–	V/V
$G_{EA}$	Error Amplifier Transconductance	–	–	800	–	$\mu\text{A/V}$
$G_{CS}$	COMP to Current Sense Transconductance	–	–	5.2	–	A/V
<b>THERMAL SHUTDOWN</b>						
$T_{OTSD}$	Thermal Shutdown (Note 2)	–	–	+160	–	$^{\circ}\text{C}$
$T_{HYS}$	Thermal Shutdown Hysteresis (Note 2)	–	–	+20	–	$^{\circ}\text{C}$
<b>SOFT START (SS PIN)</b>						
$t_{SS}$	Soft-start Time (Note 2)	$C_{SS}=0.1\mu\text{F}$	–	15	–	ms
–	Soft-start Current	$V_{SS}=0\text{V}$	–	6	–	$\mu\text{A}$

Notes: 2. Not tested, guaranteed by design.

$$3. R_{DS(on)} = \frac{V_{SW1} - V_{SW2}}{I_{SW1} - I_{SW2}}$$

**Performance Characteristics** ( $T_A=+25^\circ\text{C}$ ,  $V_{IN}=12\text{V}$ ,  $V_{OUT}=3.3\text{V}$ , unless otherwise noted.)

**Efficiency vs. Output Current**

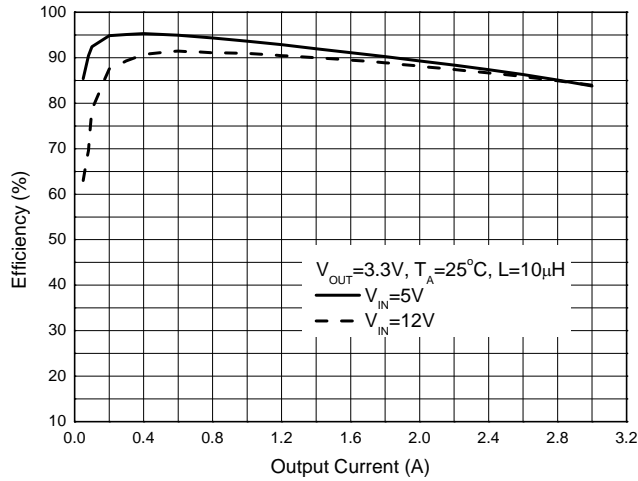

**Quiescent Current vs. Case Temperature**

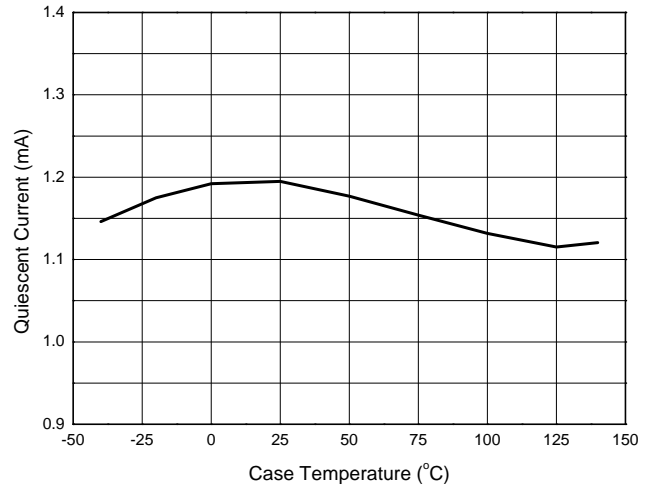

**Feedback Voltage vs. Case Temperature**

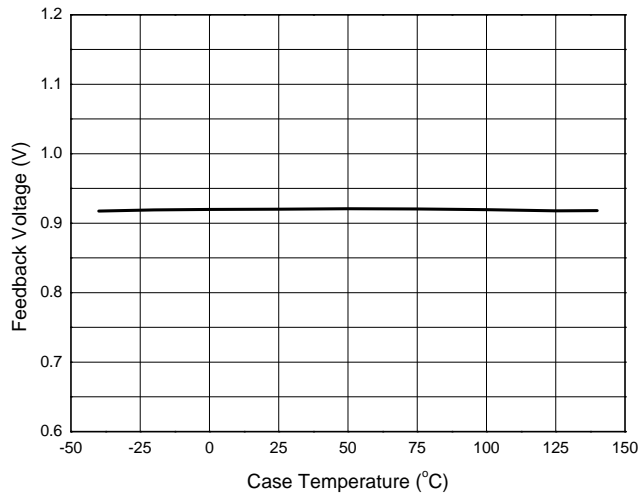

**Output Voltage vs. Output Current**

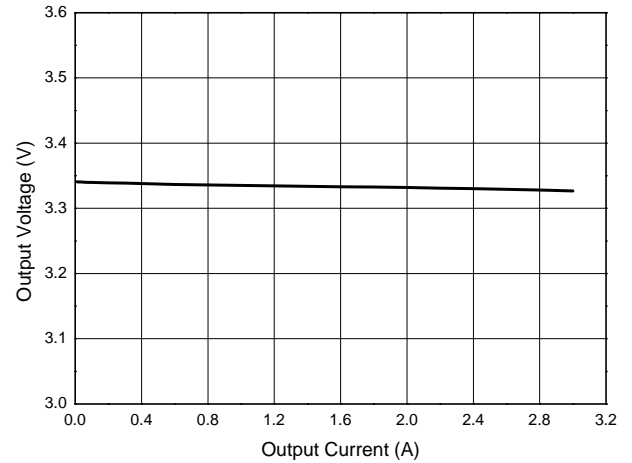

**High-side Switch On-resistance vs. Case Temperature**

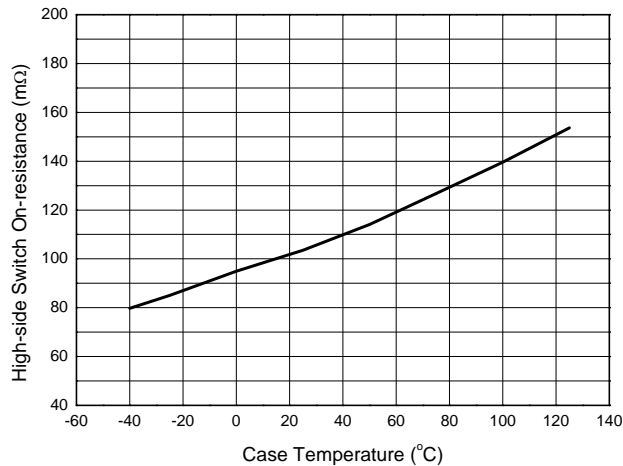

**Low-side Switch On-resistance vs. Case Temperature**

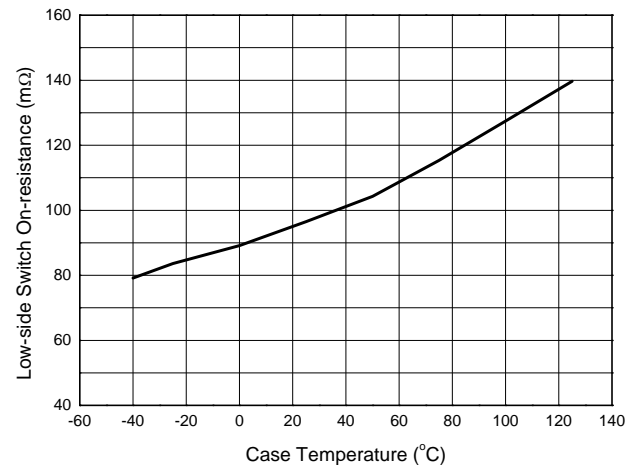

**Performance Characteristics** (Cont.  $V_{IN}=12V$ ,  $V_{OUT}=3.3V$ , unless otherwise noted.)

**Output Ripple ( $I_{OUT}=3A$ )**

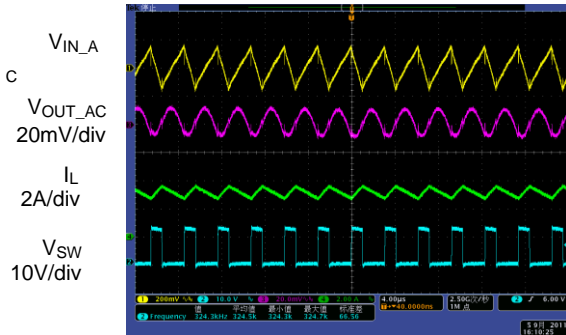

Time 4µs/div

**Load Transient ( $I_{OUT} = 1.5A$  to  $3A$ )**

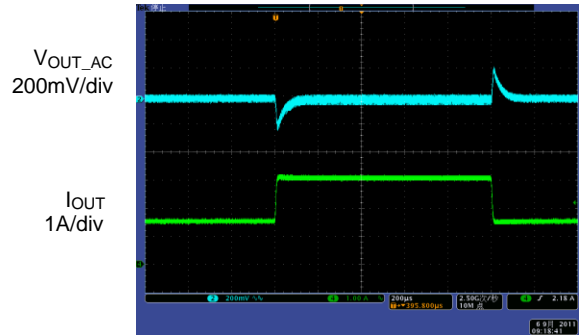

Time 200µs/div

**Enable Turn on Characteristic**  
( $V_{IN}=12V$ ,  $V_{EN}=3.3V$ ,  $V_{OUT}=3.3V$ ,  $I_L=3A$ )

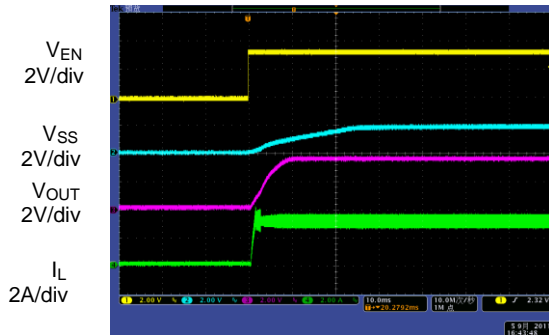

Time 10ms/div

**Enable Turn off Characteristic**  
( $V_{IN}=12V$ ,  $V_{EN}=3.3V$ ,  $V_{OUT}=3.3V$ ,  $I_L=3A$ )

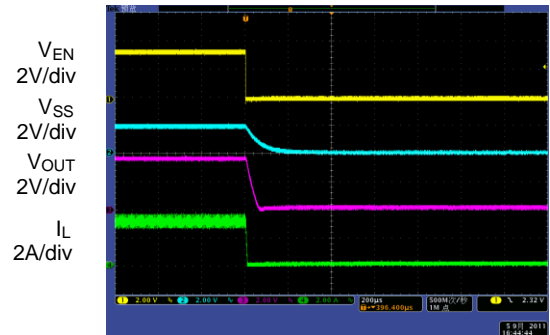

Time 200µs/div

**Short Circuit Protection ( $I_{OUT}=0A$ )**

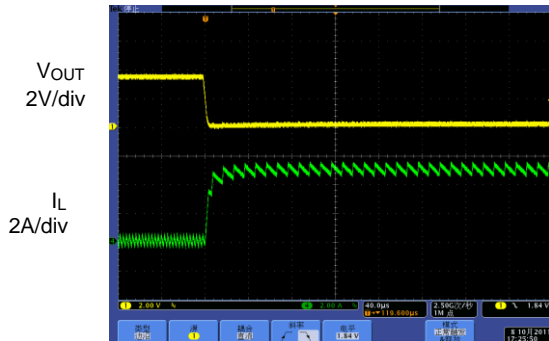

Time 40µs/div

**Short Circuit Recovery ( $I_{OUT}=0A$ )**

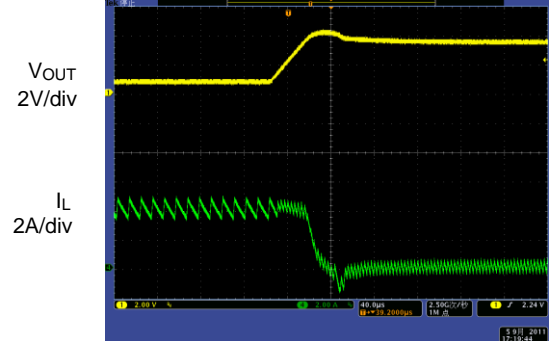

Time 40µs/div



**Ordering Information**

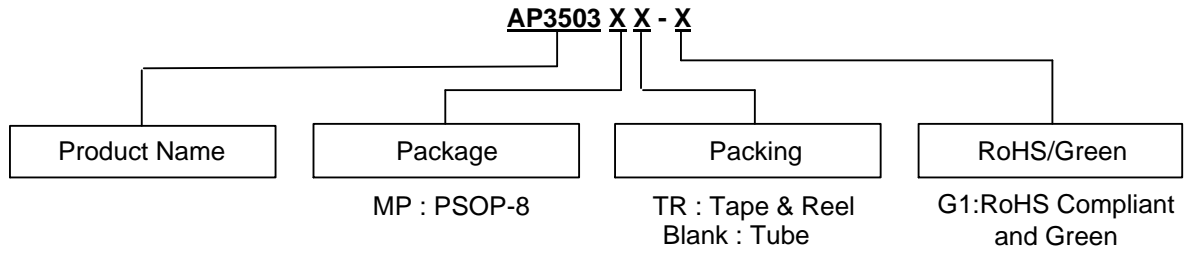

Package	Temperature Range	Part Number	Marking ID	Packing
PSOP-8	-40 to +85°C	AP3503MP-G1	3503MP-G1	Tube
		AP3503MPTR-G1	3503MP-G1	Tape & Reel

**Package Outline Dimensions** (All dimensions in mm(inch).)

(1) Package Type: PSOP-8

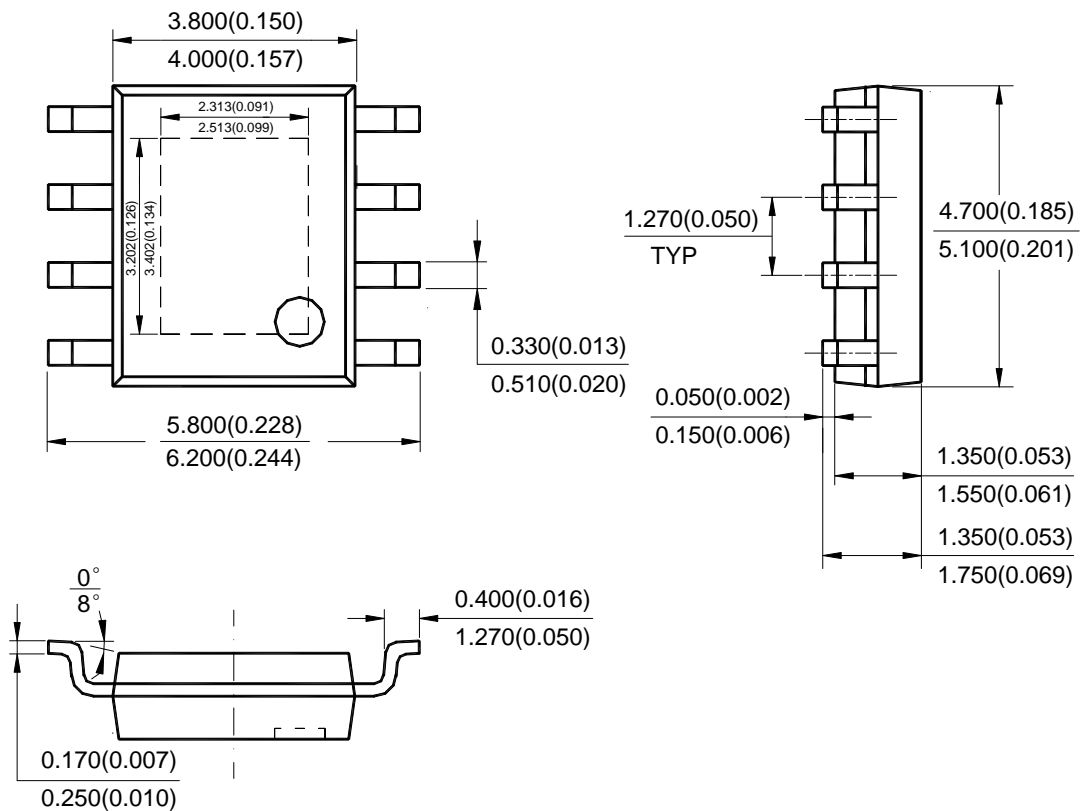

Note: Eject hole, oriented hole and mold mark is optional.

**IMPORTANT NOTICE**

DIODES INCORPORATED MAKES NO WARRANTY OF ANY KIND, EXPRESS OR IMPLIED, WITH REGARDS TO THIS DOCUMENT, INCLUDING, BUT NOT LIMITED TO, THE IMPLIED WARRANTIES OF MERCHANTABILITY AND FITNESS FOR A PARTICULAR PURPOSE (AND THEIR EQUIVALENTS UNDER THE LAWS OF ANY JURISDICTION).

Diodes Incorporated and its subsidiaries reserve the right to make modifications, enhancements, improvements, corrections or other changes without further notice to this document and any product described herein. Diodes Incorporated does not assume any liability arising out of the application or use of this document or any product described herein; neither does Diodes Incorporated convey any license under its patent or trademark rights, nor the rights of others. Any Customer or user of this document or products described herein in such applications shall assume all risks of such use and will agree to hold Diodes Incorporated and all the companies whose products are represented on Diodes Incorporated website, harmless against all damages.

Diodes Incorporated does not warrant or accept any liability whatsoever in respect of any products purchased through unauthorized sales channel. Should Customers purchase or use Diodes Incorporated products for any unintended or unauthorized application, Customers shall indemnify and hold Diodes Incorporated and its representatives harmless against all claims, damages, expenses, and attorney fees arising out of, directly or indirectly, any claim of personal injury or death associated with such unintended or unauthorized application.

Products described herein may be covered by one or more United States, international or foreign patents pending. Product names and markings noted herein may also be covered by one or more United States, international or foreign trademarks.

This document is written in English but may be translated into multiple languages for reference. Only the English version of this document is the final and determinative format released by Diodes Incorporated.

**LIFE SUPPORT**

Diodes Incorporated products are specifically not authorized for use as critical components in life support devices or systems without the express written approval of the Chief Executive Officer of Diodes Incorporated. As used herein:

A. Life support devices or systems are devices or systems which:

1. are intended to implant into the body, or
2. support or sustain life and whose failure to perform when properly used in accordance with instructions for use provided in the labeling can be reasonably expected to result in significant injury to the user.

B. A critical component is any component in a life support device or system whose failure to perform can be reasonably expected to cause the failure of the life support device or to affect its safety or effectiveness.

Customers represent that they have all necessary expertise in the safety and regulatory ramifications of their life support devices or systems, and acknowledge and agree that they are solely responsible for all legal, regulatory and safety-related requirements concerning their products and any use of Diodes Incorporated products in such safety-critical, life support devices or systems, notwithstanding any devices- or systems-related information or support that may be provided by Diodes Incorporated. Further, Customers must fully indemnify Diodes Incorporated and its representatives against any damages arising out of the use of Diodes Incorporated products in such safety-critical, life support devices or systems.

Copyright © 2018, Diodes Incorporated

[www.diodes.com](http://www.diodes.com)