

# Kinghelm®

REV.	BCN NO OR DESCRIPTION	REVISED	DATE
A	PROPOSE ONLY	ERIC	2014.08.13

**SPECIFICATIONS:**

**1. ELECTRICAL CHARACTERISTICS:**

- 1-1. CONTACT RESISTANCE: 30m MAX.  $\leq$
- 1-2. DIELECTRIC WITHSTANDING VOLTAGE: 100V AC FOR ONE MINUTE.
- 1-3. INSULATION RESISTANCE: 100M MIN. MEASURED BY 500 VDC

**2. MECHANICAL CHARACTERISTICS:**

- 2-1. INSERTION FORCE :0.5-2.0Kgf(REF.)
- 2-2. WITHDRAWAL FORCE :0.8-2.0Kgf(REF.)

**3. LIFE TEST: 10,000 CYCLES.**

**4. TO CONFORM TO THE KRCONN HAZARDOUS SUBSTANCE FREE SPEC.**

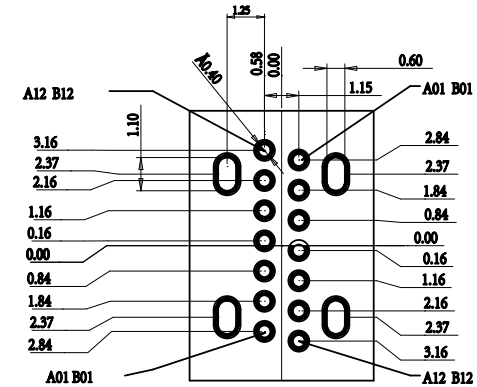
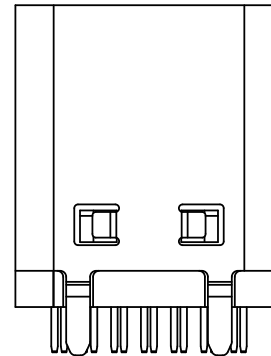
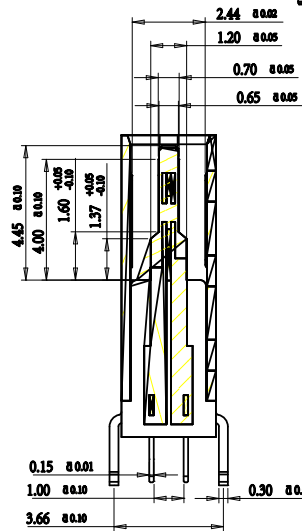
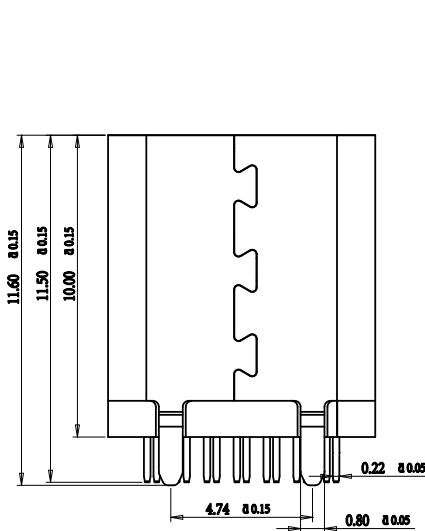
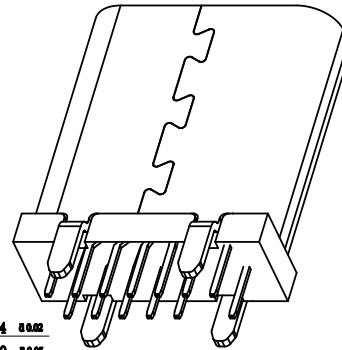
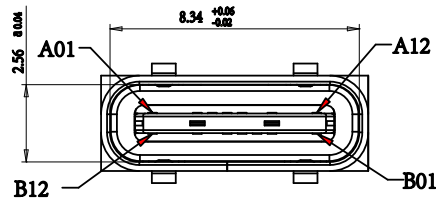

截面 1-1

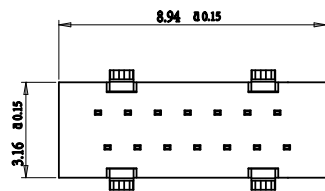

PIN	SIGNAL NAME	PIN	SIGNAL NAME
A1	GND	B12	GND
A4	VBUS	B9	VBUS
A5	CC1		
A6	DP1	B7	DN2
A7	DN1	B6	DP2
		B5	CC2
A9	VBUS	B4	VBUS
A12	GND	B1	GND

NO.	DESCRIPTION	MATERIAL	REMARKS	QTY
6	SHELL	STAINLESS STEEL	NI Plated	1PCS
5	SHIELDING PLATE	STAINLESS STEEL	---	1PCS
4	MD	HIGH TEMPERATURE PLASTIC	BLACK	1PCS
3	CONTACT	COPPER ALLOY	Au/Ni Plated	1SFT
2	CONTACT	COPPER ALLOY	Au/Ni Plated	1SFT
1	HOUSING	HIGH TEMPERATURE PLASTIC	BLACK	1PCS

深圳市金航标电子有限公司 WWW.BDS666.COM  
KH-TYPE-C-4L10-14P 0755-83044319

DECIMALS:		ANGLES:		TITLE	
X	:±0.5	X	:±2'	DWN	Johnie
XX	:±0.10	XX	:±1'	CHKD	Kevin.d
XXX	:±0.05			APVD	Simon.Mo
XXX	:±0.02				

TYPE-C 母 180度插板 10.0  
DG-JSX-USB3.1-14BK-01U-002  
SCALE:1:1 UNIT: mm  
SIZE: A4 SHEET:1/0F1 REV: A  
CUSTOMER COPY