

"weatherproof", for outdoor installation

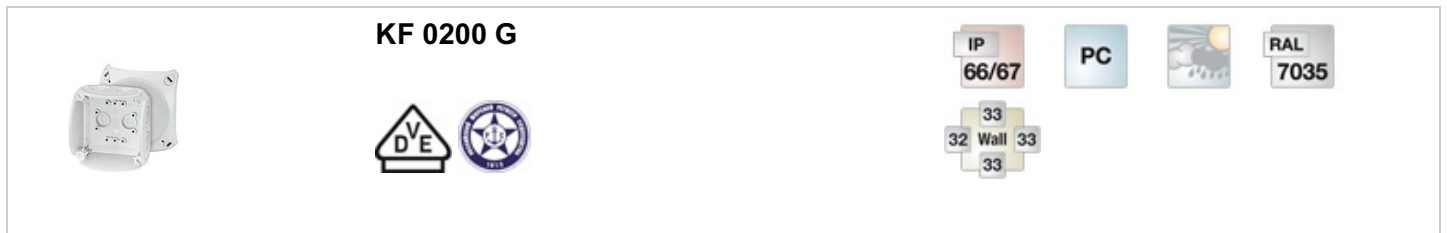

- without terminals
- Cable entries via knockouts, order AKM separately (see cable entry systems LES)
- "weatherproof" resistant to weather influences (UV due to solar radiation, protected against rainwater, temperature resistant, impact resistant, etc.)
- saltwater-proof
- "Offshore applications"
- lid fasteners sealable without accessories
- colour: grey, RAL 7035

Degree of protection:	IP 66 / IP 67 temporary submersion up to 1 meter, max. 15 minutes
Material:	PC (Polycarbonate)
mounting width	74 mm
mounting height	74 mm
max. installation depth	47 mm
width	93 mm
height:	93 mm
depth	62 mm
Weight	0,11 kg
in accordance with	IEC 60 670-22
in accordance with	Russian Maritime Register of Shipping, technical documentation is approved by the letter No. 250-A-1180-108795

Drawings

Dimension drawing

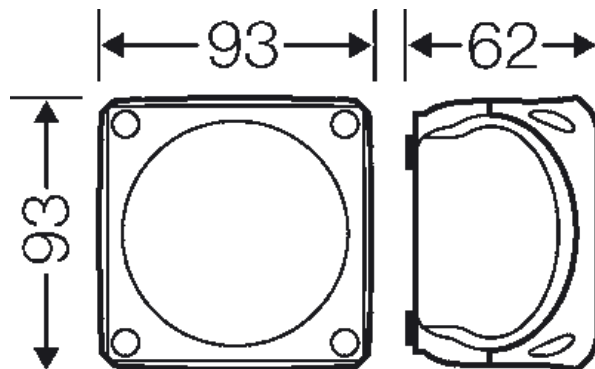

"weatherproof", for outdoor installation



KF 0200 G





Detail mass

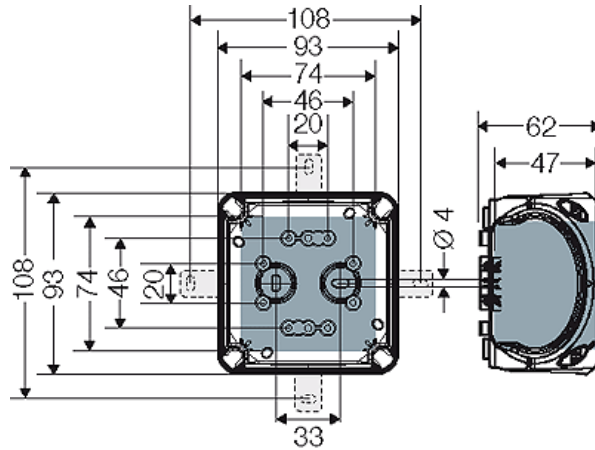

Box walls



32



1 x M 20

33



2 x M 20

Operating and ambient conditions

Application area	Suitable for outdoor installation (harsh environment and/or outdoor). To reduce the formation and accumulation of condensed water see technical information.
Resistant to occasional cleaning procedures (direct jet)	Resistant to occasional cleaning procedures (direct jet) with high-pressure cleaner without additives, water pressure: max. 100 bar, water temperature: max. 80° C, distance => 0,15 m, in accordance with the requirements IP 69K, enclosure and cable glands at least IP 65
Ambient temperature	Average value over 24 hours + 55 °C Maximum value + 70 °C Minimum value - 25 °C
Fire protection in the event of internal faults	Demands placed on electrical devices from standards and laws Minimum requirements - Glow wire test in accordance with IEC 60 695-2-11: - 650°C for boxes and cable glands - 850°C for parts of insulating material necessary to retain current carrying parts in position
Burning behaviour	Glow wire test IEC 60 695-2-11: 960 °C UL Subject 94: V-0 flame-retardant self-extinguishing

"weatherproof", for outdoor installation



KF 0200 G





Degree of protection against mechanical load	IK09 (10 Joule)
Toxic behaviour	halogen-free silicone-free "halogen-free" in accordance with the examination of the cables and insulated wires - corrosiveness of fumes - as per IEC 60 754-2
Note:	For material properties see technical data.