

### SPLIT-TYPE FORK TURRETS

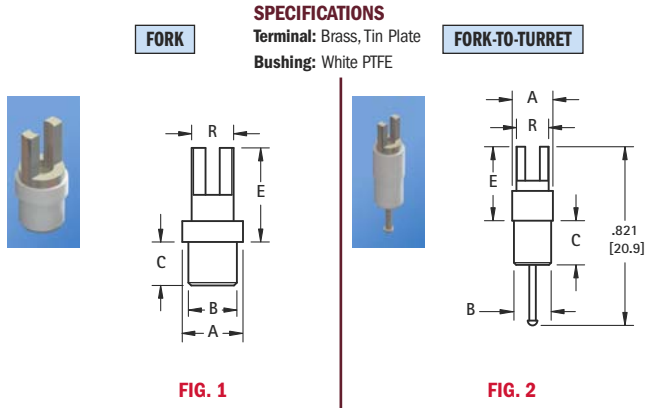

CAT. NO.	FIG. NO.	A	B	C	E	R	Mtg. Hole Dia.
11100	1	.172 (4.4)	.148 (3.8)	.125 (3.2)	.250 (6.4)	.125 (3.2)	.136 (3.5)
11111	1	.187 (4.8)	.171 (4.3)	.150 (3.8)	.390 (9.9)		
11112	1	.187 (4.8)	.171 (4.3)	.150 (3.8)	.453 (11.5)		
11113	1	.187 (4.8)	.171 (4.3)	.150 (3.8)	.328 (8.3)	.148 (3.8)	.158 (4.0)
11114	1	.187 (4.8)	.171 (4.3)	.150 (3.8)	.390 (9.9)		
11115	1	.187 (4.8)	.171 (4.3)	.150 (3.8)	.453 (11.5)		
11116	2	.187 (4.8)	.171 (4.3)	.212 (5.4)	.390 (9.9)		

### THREADED TURRET TERMINALS

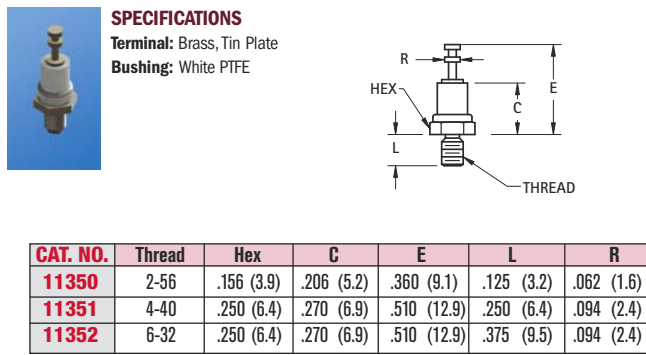

### THREADED FEED - THRU TERMINALS

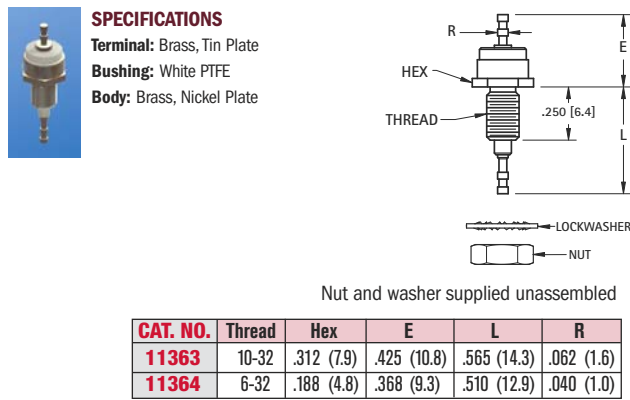
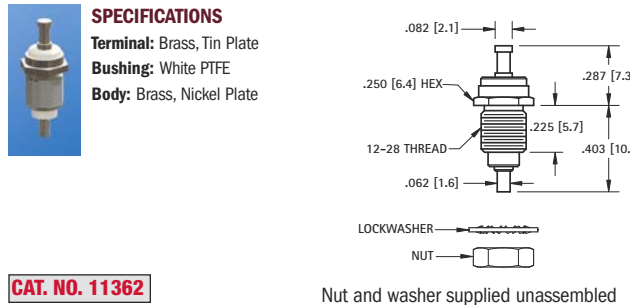
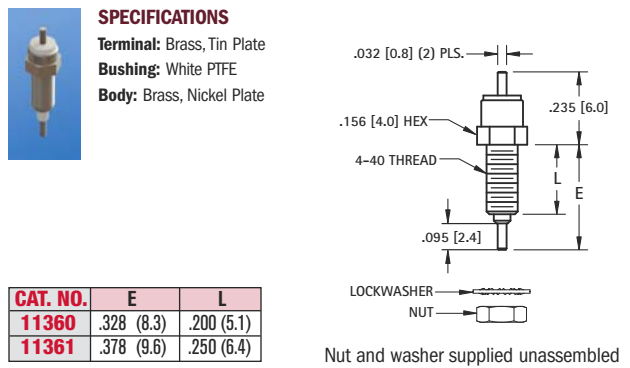

### MOLDED DIALLYL PHTHALATE INSULATED THREADED TERMINALS

**MATERIAL:**  
**Terminal:** Brass, Tin Plate  
**Insulator:** Blue Molded Diallyl Phthalate, SDGF  
**Base:** Brass, Tin Plate

**Properties:**

- High Dielectric Breakdown
- Continuous Use Temperature up to 350°F (176 °C)
- UL 94 V-0 Rated
- Other platings and insulator colors available upon request

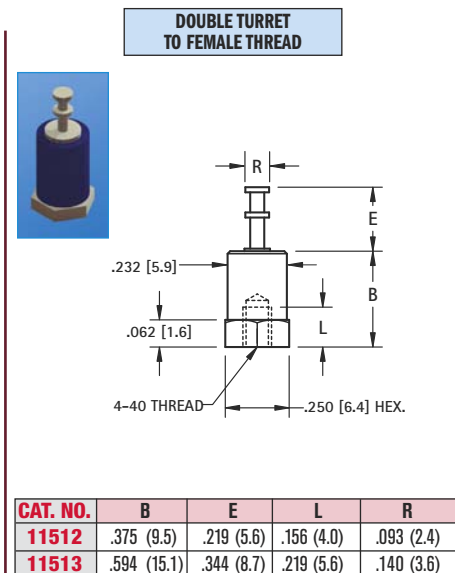
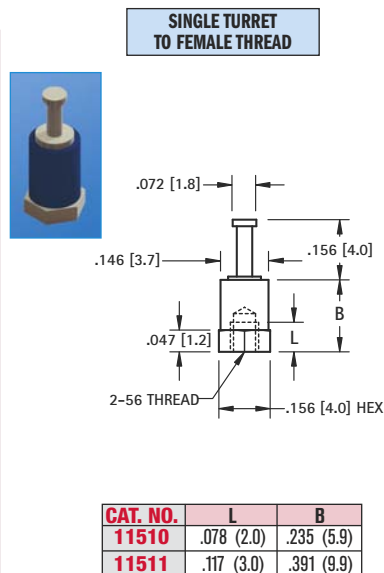
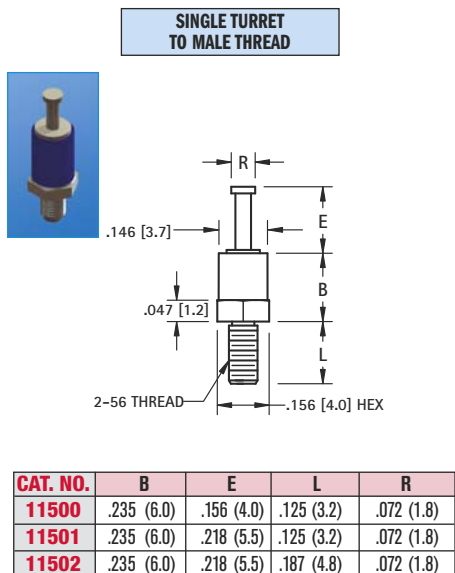

INSULATED TERMINALS