

# High Voltage NPN Transistor with Diode

**TO-251**

**TO-252**

**Pin Definition:**

1. Base
2. Collector
3. Emitter

**PRODUCT SUMMARY**

<b><math>BV_{CEO}</math></b>	400V
<b><math>BV_{CBO}</math></b>	700V
<b><math>I_C</math></b>	4A
<b><math>V_{CE(SAT)}</math></b>	1.5V @ $I_C / I_B = 4A / 1A$

**Features**

- Build-in Free-wheeling Diode Makes Efficient Anti-saturation Operation
- No Need to Interest an hfe Value Because of Low Variable Storage-time Spread Even Though Corner Spirit Product.
- Low Base Drive Requirement
- Suitable for Half Bridge Light Ballast Application

**Structure**

- Silicon Triple Diffused Type
- NPN Silicon Transistor
- Integrated Anti-parallel Collector-Emitter Diode

**Ordering Information**

Part No.	Package	Packing
SL5304DCP	TO-252	2.5Kpcs / 13" Reel
SL5304I	TO-251	75pcs / Tube

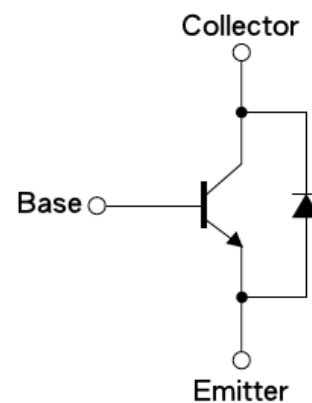
**Block Diagram**

**Absolute Maximum Rating** ( $T_a = 25^\circ\text{C}$  unless otherwise noted)

Parameter	Symbol	Limit	Unit
Collector-Base Voltage	$V_{CBO}$	700	V
Collector-Emitter Voltage @ $V_{BE}=0V$	$V_{CES}$	700	V
Collector-Emitter Voltage	$V_{CEO}$	400	V
Emitter-Base Voltage	$V_{EBO}$	9	V
Collector Current	$I_C$	4	A
Collector Peak Current ( $t_p < 5ms$ )	$I_{CM}$	8	A
Base Current	$I_B$	2	A
Base Peak Current ( $t_p < 5ms$ )	$I_{BM}$	4	A
Power Total Dissipation @ $T_c=25^\circ\text{C}$	$P_{TOT}$	35	W
Maximum Operating Junction Temperature	$T_J$	+150	$^\circ\text{C}$
Storage Temperature Range	$T_{STG}$	-55 to +150	$^\circ\text{C}$

**Thermal Performance**

Parameter	Symbol	Limit	Unit
Thermal Resistance - Junction to Case	$R_{\theta_{JC}}$	3.57	$^{\circ}\text{C/W}$
Thermal Resistance - Junction to Ambient	$R_{\theta_{JA}}$	68	$^{\circ}\text{C/W}$

**Electrical Specifications** ( $T_a = 25^{\circ}\text{C}$  unless otherwise noted)

Parameter	Conditions	Symbol	Min	Typ	Max	Unit
<b>Static</b>						
Collector-Base Voltage	$I_C = 1\text{mA}, I_B = 0$	$BV_{CBO}$	700	--	--	V
Collector-Emitter Breakdown Voltage	$I_C = 10\text{mA}, I_E = 0$	$BV_{CEO}$	400	--	--	V
Emitter-Base Breakdown Voltage	$I_E = 1\text{mA}, I_C = 0$	$BV_{EBO}$	9	--	--	V
Collector Cutoff Current	$V_{CB} = 700\text{V}, I_E = 0$	$I_{CBO}$	--	--	100	$\mu\text{A}$
Collector Cutoff Current	$V_{CE} = 400\text{V}, I_B = 0$	$I_{CEO}$	--	--	250	$\mu\text{A}$
Emitter Cutoff Current	$V_{EB} = 7\text{V}, I_C = 0$	$I_{EBO}$	--	--	10	$\mu\text{A}$
Collector-Emitter Saturation Voltage	$I_C = 0.5\text{A}, I_B = 0.1\text{A}$	$V_{CE(SAT)1}$	--	0.25	0.7	V
	$I_C = 1\text{A}, I_B = 0.2\text{A}$	$V_{CE(SAT)2}$	--	0.5	1	
	$I_C = 2.5\text{A}, I_B = 0.5\text{A}$	$V_{CE(SAT)3}$	--	1.2	1.5	
	$I_C = 4\text{A}, I_B = 1\text{A}$	$V_{CE(SAT)4}$	--	0.5	--	
Base-Emitter Saturation Voltage	$I_C = 1\text{A}, I_B = 0.2\text{A}$	$V_{BE(SAT)1}$	--	--	1.1	V
	$I_C = 2\text{A}, I_B = 0.5\text{A}$	$V_{BE(SAT)2}$	--	--	1.2	
DC Current Gain	$V_{CE} = 5\text{V}, I_C = 10\text{mA}$	Hfe	10	--	--	
	$V_{CE} = 5\text{V}, I_C = 1\text{A}$		17	--	27	
	$V_{CE} = 5\text{V}, I_C = 2\text{A}$		12	--	32	
Forward Voltage Drop	$I_F = 2\text{A}$	Vf	--	--	2	V
Turn On Time	$V_{CC} = 250\text{V}, I_C = 1\text{A},$	$t_{ON}$	--	0.2	0.6	$\mu\text{S}$
Storage Time	$I_{B1} = I_{B2} = 0.2\text{A}, t_p = 25\mu\text{S}$	$t_{STG}$	--	3.0	4.5	$\mu\text{S}$
Fall Time	Duty Cycle < 1%	$t_f$	--	0.2	0.3	$\mu\text{S}$

 Notes: Pulsed duration = 380 $\mu\text{S}$ , duty cycle  $\leq 2\%$

**Electrical Characteristics Curve** ( $T_a = 25^\circ\text{C}$ , unless otherwise noted)

**Figure 1. Static Characteristics**

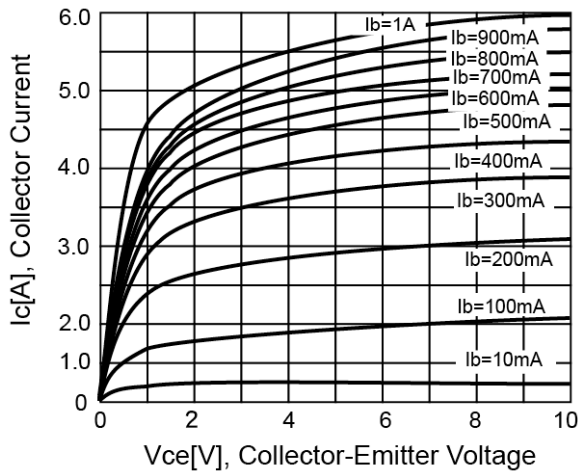

**Figure 2. DC Current Gain**

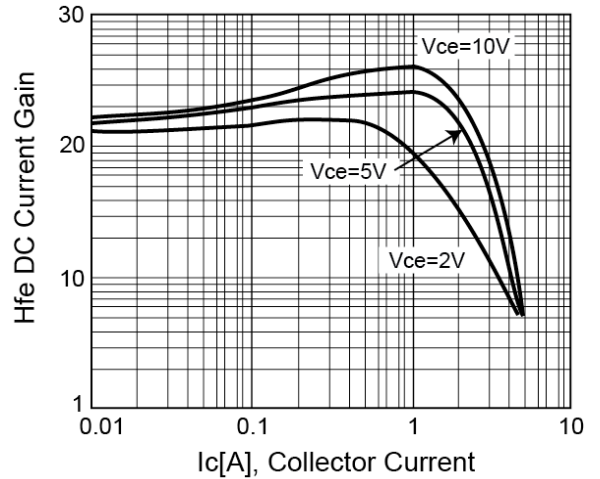

**Figure 3.  $V_{ce(sat)}$  v.s.  $V_{be(sat)}$**

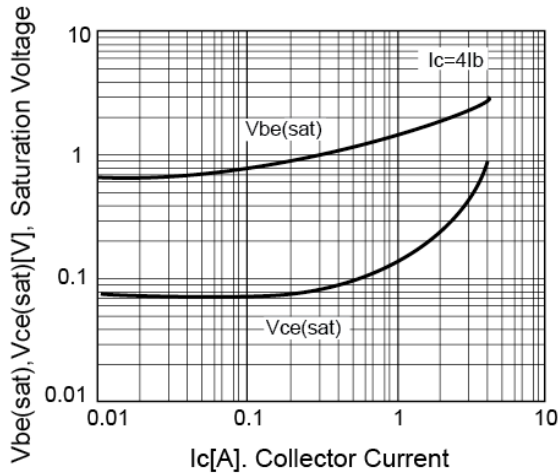

**Figure 4. Power Derating**

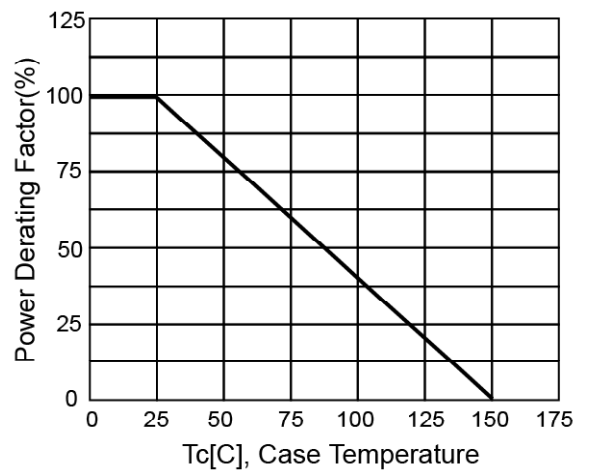

**Figure 5. Reverse Bias SOA**

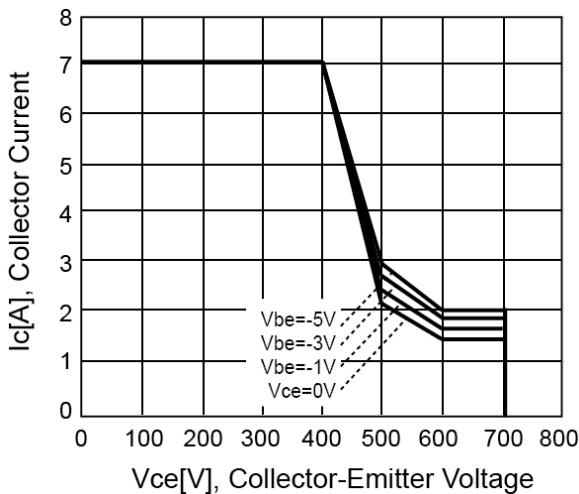

**Figure 6. Safety Operating Area**

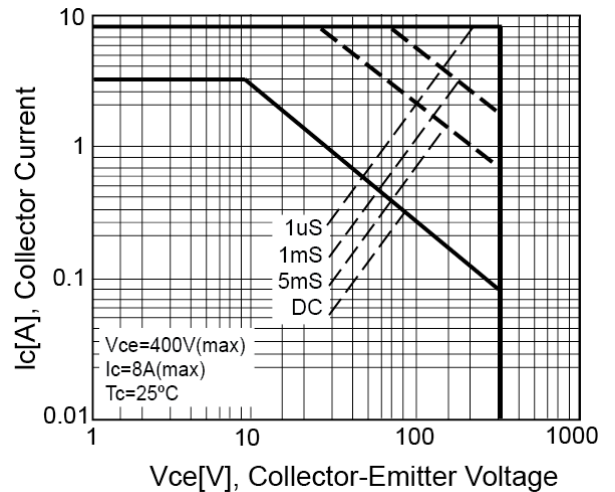

## TO-252 Mechanical Drawing

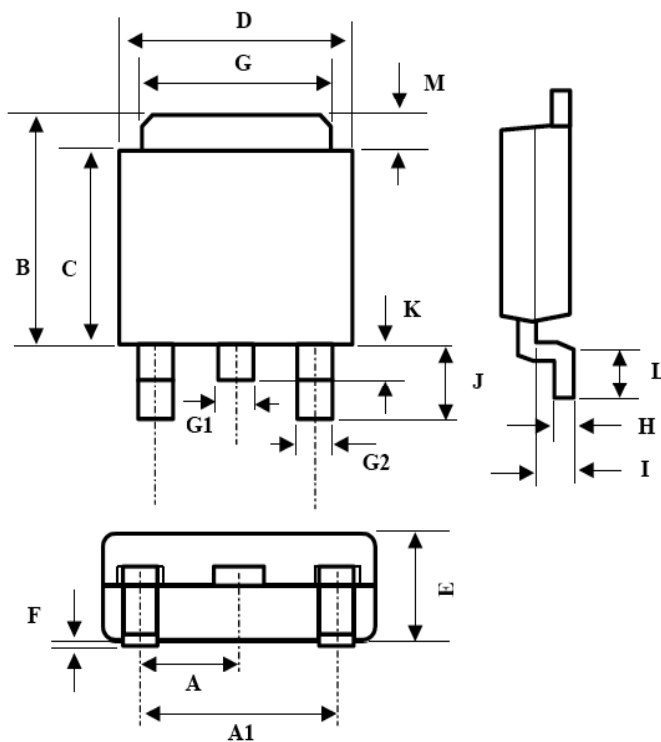

TO-252 DIMENSION				
DIM	MILLIMETERS		INCHES	
	MIN	MAX	MIN	MAX
A	2.290 BSC		0.090 BSC	
A1	4.600 BSC		0.180 BSC	
B	7.000	7.200	0.275	0.283
C	6.000	6.200	0.236	0.244
D	6.400	6.604	0.252	0.260
E	2.210	2.387	0.087	0.094
F	0.010	0.127	0.000	0.005
G	5.232	5.436	0.206	0.214
G1	0.814	0.889	0.032	0.035
G2	0.814	0.889	0.032	0.035
H	0.508 REF		0.020 REF	
I	0.900	1.500	0.035	0.059
J	2.743 REF		0.108 REF	
K	0.660	0.094	0.026	0.037
L	1.397	1.651	0.055	0.065
M	1.100 REF		0.043 REF	

## TO-251 Mechanical Drawing

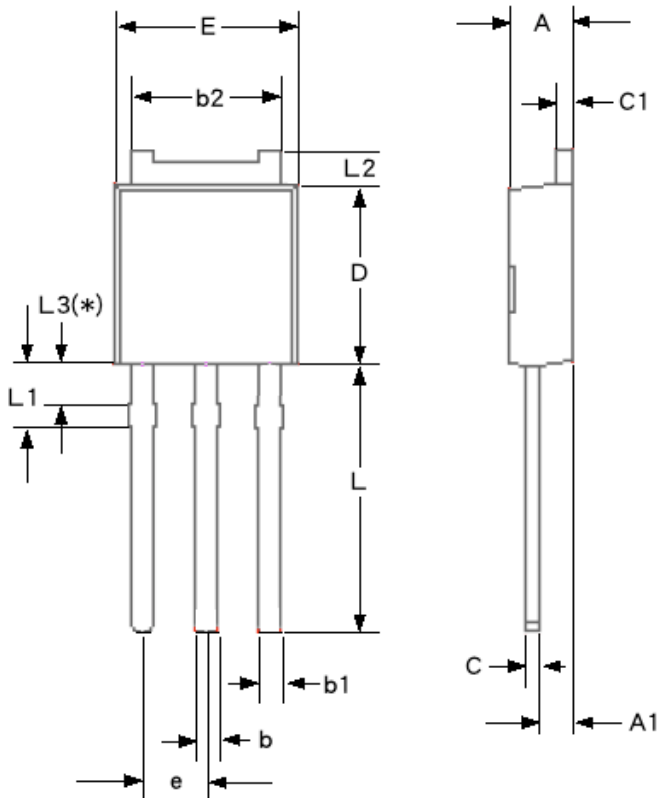

DIM	TO-251 DIMENSION			
	MILLIMETERS		INCHES	
	MIN	MAX	MIN	MAX
A	2.190	2.380	0.0862	0.0937
A1	0.890	1.140	0.0350	0.0449
b	0.640	0.890	0.0252	0.0350
b1	0.760	1.140	0.0299	0.0449
b2	5.210	5.460	0.2051	0.2150
C	0.460	0.580	0.0181	0.0228
C1	0.460	0.580	0.0181	0.0228
D	5.970	6.100	0.2350	0.2402
E	6.350	6.730	0.2500	0.2650
e	2.280 BSC		0.0898 BSC	
L	8.890	9.650	0.3500	0.3799
L1	1.910	2.280	0.0752	0.0898
L2	0.890	1.270	0.0350	0.0500
L3	1.150	1.520	0.0453	0.0598