



# UM7500

## POWER PIN DIODES

### DESCRIPTION

The UM7500 series features Microsemi's innovative passivated chip design which takes advantage of the latest silicon wafer bonding and junction passivation techniques. This new series of PIN diodes incorporates all of the desirable RF properties of previous Microsemi diodes plus extremely low leakages and very stable reverse characteristics. Power dissipation capability is assured by Microsemi's metallurgically bonded, fused in glass construction. This technique continues to be the optimum approach for applications requiring reliable, high power diodes.

Low leakage distortion is achieved by maintaining high carrier lifetime and accurately controlling I-region thickness throughout the process. The UM7500 series is designed for use in a broad range of RF and microwave switch and attenuator circuits. The packages make this series suitable for many high-end medical applications such as MRI and CAT scan equipment. For military applications, the new series is capable of meeting all the requirements of MIL-STD-750 including HTRB screening at 80% of rated voltage at 150 °C.

### KEY FEATURES

- Voltage Ratings to 1400 Volt
- Fully Passivated PIN Chip
- Low Leakage, IR < 0.5 μA
- Void Less, Particle Free Construction
- Hermetic Fused in Glass
- Low Loss, Low Distortion
- Surface Mount Package Available
- Metallurgically Bonded, Thermally Matched Construction
- Compatible with automatic insertion equipment

**IMPORTANT:** For the most current data, consult MICROSEMI's website: <http://www.microsemi.com>

### ABSOLUTE MAXIMUM RATINGS AT 25° C (UNLESS OTHERWISE SPECIFIED)

| Package                                 | Condition                                       | PD                 | θ                  |
|---|---|--------------------|--------------------|
| A                                       | 25 °C Pin Temperature                           | 10 W               | 15 °C/W            |
| B & E                                   | ½ in. total length to 25 °C Contact<br>Free Air | 5.5 W              | 27.5 °C/W<br>1.5 W |
| C                                       | 25 °C Stud Temperature                          | 10 W               | 15 °C/W            |
| D                                       | 25 °C Stud Temperature                          | 7.5 W              | 20 °C/W            |
| SM                                      | 25 °C End Cap Temperature                       | 7.5 W              | 20 °C/W            |
| All                                     | 1 us pulse (Single)                             | 35 kW              |                    |
| OPERATING AND STORAGE TEMPERATURE RANGE |   | -65 °C to + 175 °C |                    |

### APPLICATIONS/BENEFITS

- Isolated stud package available
- Surface mount package available
- RoHS compliant packaging available: use UMX7501B, etc.

### VOLTAGE RATINGS

#### Reverse Voltage @ 0.5 uA

|       |        |
|-------|--------|
| 100V  | UM7501 |
| 200V  | UM7502 |
| 400V  | UM7504 |
| 600V  | UM7506 |
| 800V  | UM7508 |
| 1000V | UM7510 |
| 1200V | UM7512 |
| 1400V | UM7514 |

**ELECTRICAL PARAMETERS @ 25°C (unless otherwise specified)**

| Parameter                        | Symbol        | Conditions                           | MIN. | TYPICAL | MAX. | Units         |
|----------------------------------|---------------|--------------------------------------|------|---------|------|---------------|
| Total Capacitance                | CT            | $V_R=100V, F=1\text{ MHz}$           |      | 0.8     | 1.0  | pF            |
| Series Resistance                | $R_S$         | $I_f=50\text{ mA}, F=100\text{ MHz}$ |      | 0.8     | 1.0  | Ohms          |
| Parallel Resistance              | $R_p$         | $V_R=100\text{ V}, F=100\text{ MHz}$ | 100k | 150k    |      | Ohms          |
| Parallel Resistance              | $R_p$         | $V_R=0\text{ V}, F=100\text{ MHz}$   | 10k  | 15k     |      | Ohms          |
| Carrier Lifetime                 | $\tau$        | $I_f=10\text{ mA}$                   | 2.5  | 3.5     |      | $\mu\text{s}$ |
| Reverse Current                  | $I_R$         | $V_R = \text{Voltage rating}$        |      | 0.1     | 0.5  | $\mu\text{A}$ |
| I-Region Width                   | W             | -                                    |      | 100     |      | $\mu\text{m}$ |
| Forward Voltage                  | $V_F$         | $I_f=50\text{ mA}$                   |      | 0.8     | 1.0  |               |
| Forward Bias Harmonic Distortion | (R2a/a,R3a/a) | 100 MHz, P=30W, $I_f=50\text{mA}$    | 80   | 90      |      | dBc           |
| Reverse Bias Harmonic Distortion | (R2a/a,R3a/a) | 100 MHz, P=0dBm, $V_R=0V$            | 60   | 70      |      | dBc           |

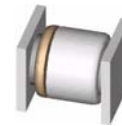
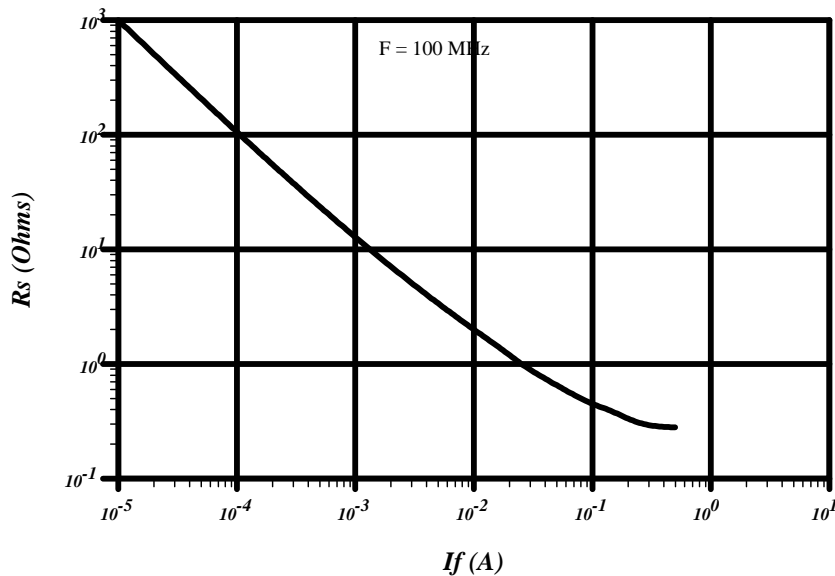
**Style "B"**

**Style "SM"**
**UM7500  
TYPICAL**

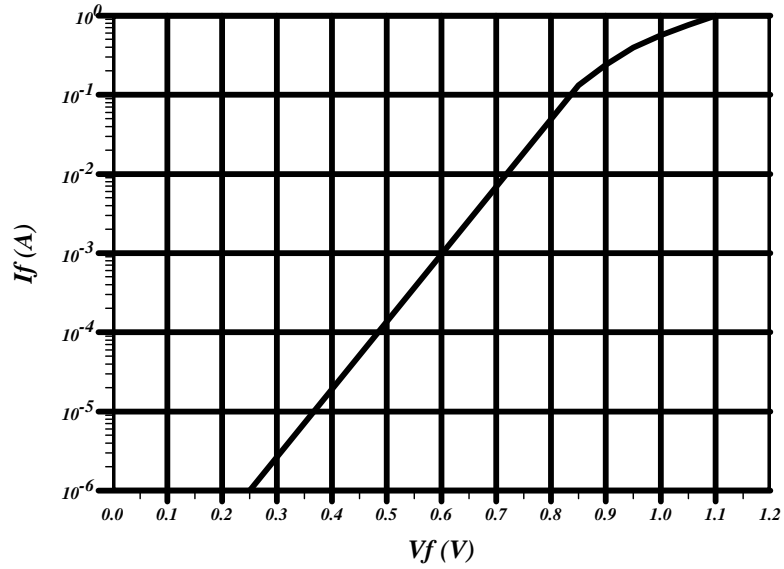
*UM7500  
TYPICAL*

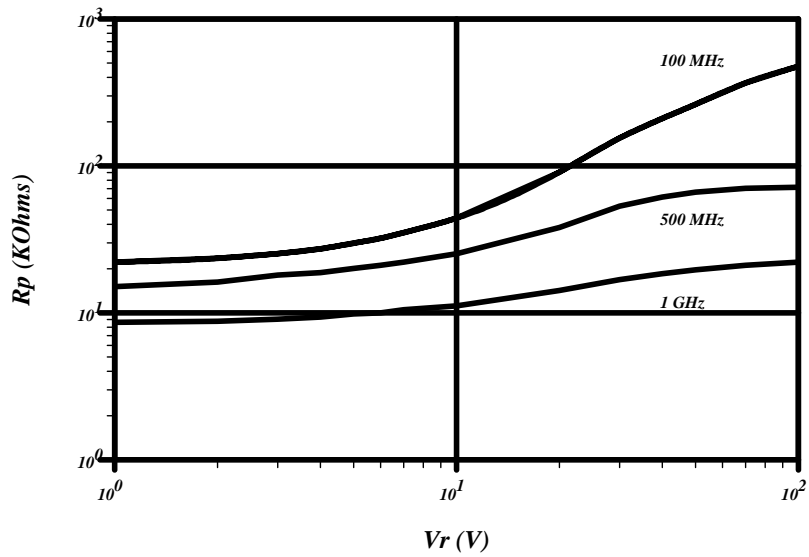

*UM7500  
TYPICAL*



UM7500  
TYPICAL

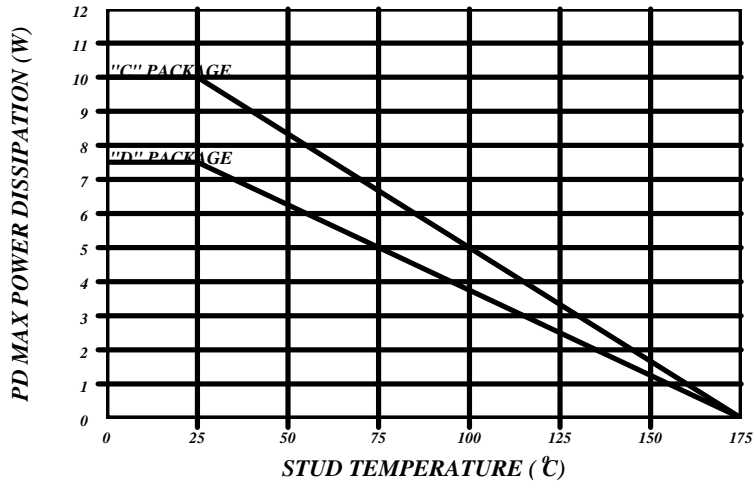

UM7500  
TYPICAL

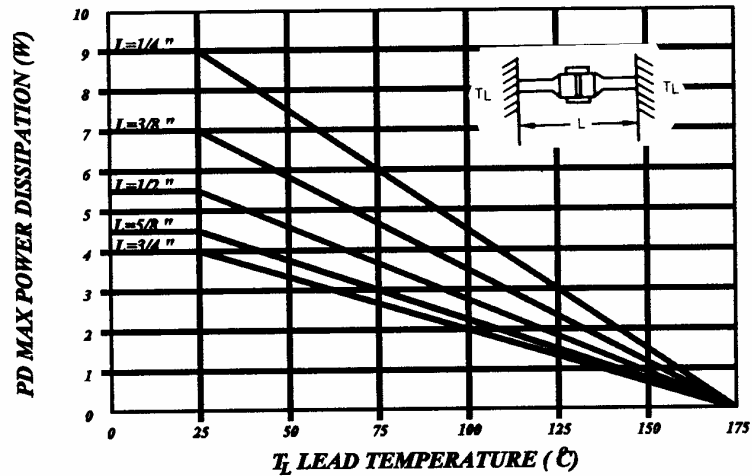

UM7500  
TYPICAL

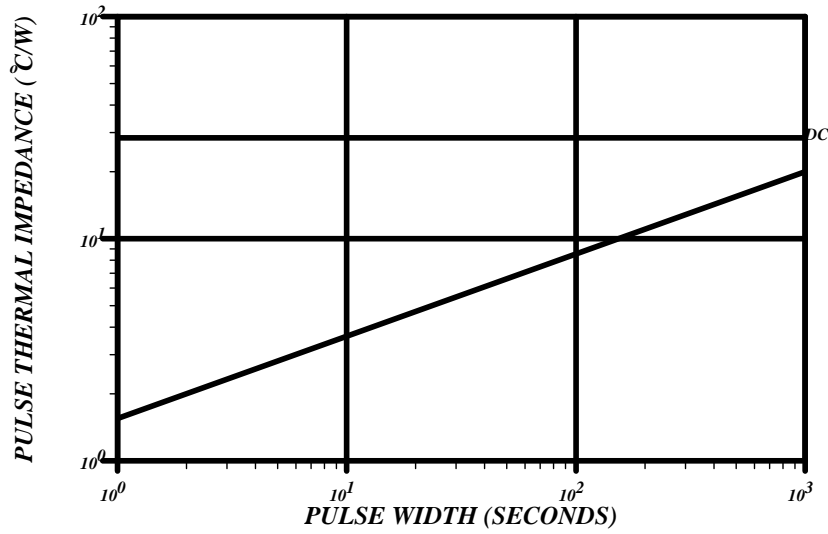

UM7500  
TYPICAL

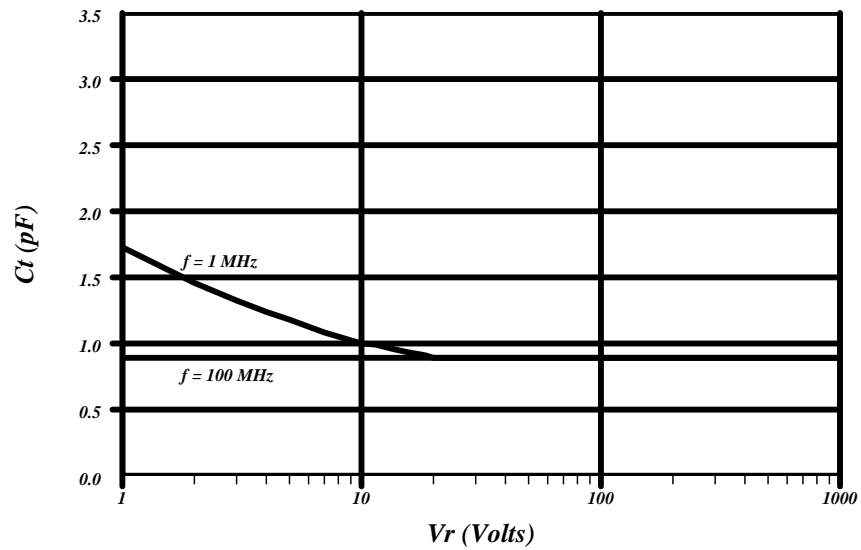

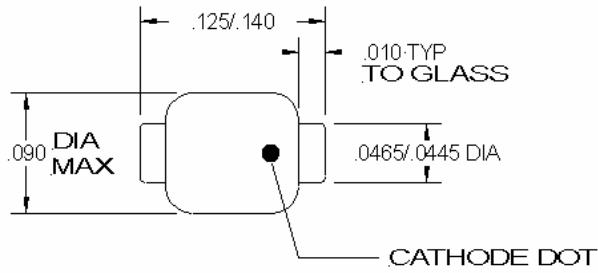
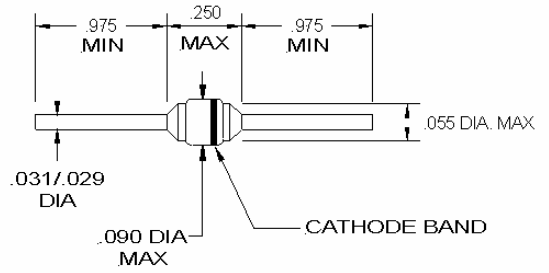
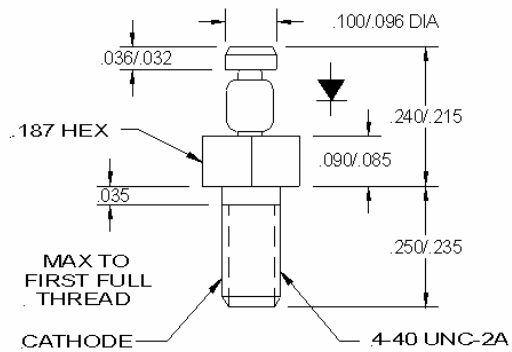
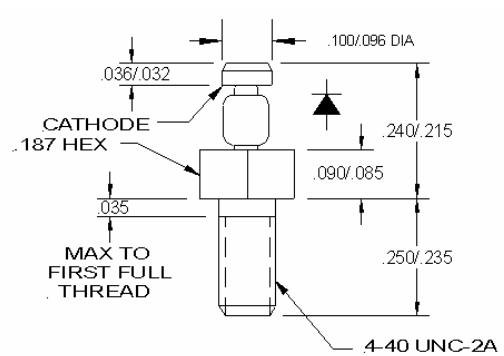
**STYLE "A"**

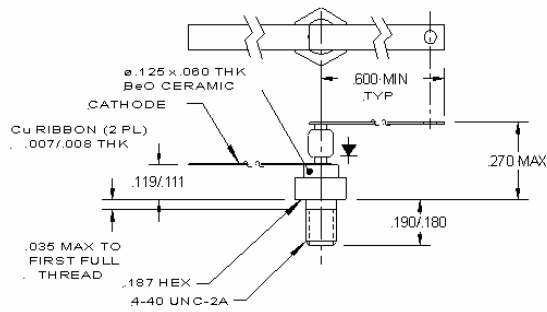
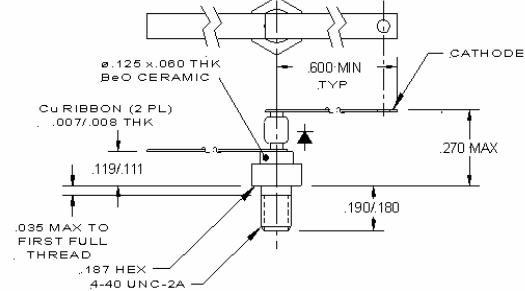
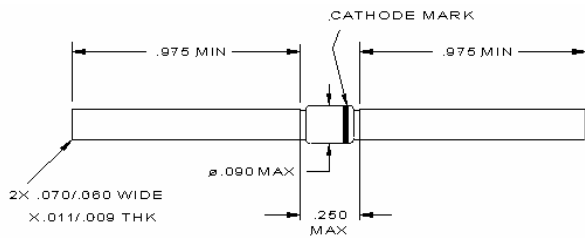
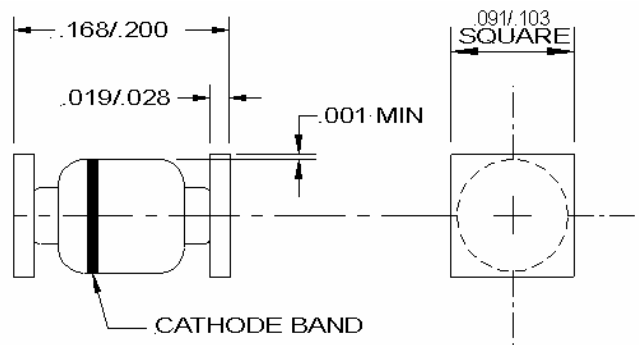
**STYLE "B"**

**STYLE "C"**

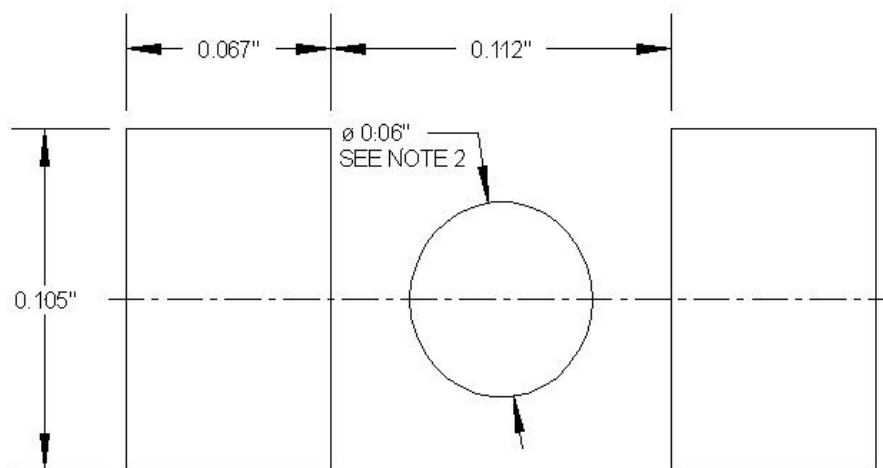
**STYLE "CR"**

**STYLE "D"**

**STYLE "DR"**

**STYLE "E"**

**STYLE "SM"**

## STYLE "SM" FOOTPRINT

A SIZE  
(STANDARD SMALL  
SQUARE END CAP OUTLINE)

## NOTES:

1. These dimensions will match the terminals and provide for additional solder fillets at the outboard ends at least as wide as the terminals themselves, assuming accuracy of placement within 0.005"
2. If the mounting method chosen requires use of an adhesive separate from the solder compound, a round (or square) spot of cement as shown should be centrally located.





UM7500

POWER PIN DIODES

NOTES: