



■ 概述

MAX485EESA是用于RS-485 与 RS-422 通信的低功耗收发器, 其中包含一个驱动器和一个接收器, 且MAX485EESA的驱动器摆率不受限制, 可以实现最高2.5Mbps 的传输速率, 属于半双工应用设计。

MAX485EESA工作在5V单电源下, 另外, MAX485EESA有驱动使能(DE) 和接收使能(RE)管脚, 其驱动器具有短路电流限制, 并可以通过热关断电路将驱动器输出置为高阻状态, 防止过度的功率损耗。接收器输入具有失效保护特性, 当输入开路时, 可以确保逻辑高电平输出。

■ 引脚定义



Pin 1

SOP-8
(SOIC-8)

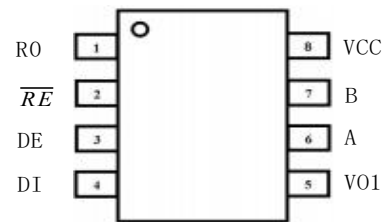

■ 描述

- 三态输出。
- 半双工设计。
- 汇流排允许多达 256 个收发器。
- SOP-8(SOIC-8) 封装

■ 应用领域

- 低功耗 RS-485 收发器。
- 低功耗 RS-422 收发器。
- 电平转换器。
- 用于 EMI 敏感应用的收发器。
- 工业控制局域网

■ 引脚描述

序号	符号	功能描述
1	RO	接收器输出: 若 $V_A > V_B$ 200mV时, RO为高电平, 若 $V_A < V_B$ 200mV时, RO为低电平
2	\overline{RE}	接收器输出使能端: 低电平有效, \overline{RE} 为高时, 接收输出为高阻
3	DE	发送使能端: 高电平有效, DE为低电平时, 发送输出为高阻。DE为高电平时, 晶片工作在发送状态, DE为低电平且 \overline{RE} 为低电平时晶片工作在接收状态。
4	DI	驱动器输入端: DI为低电平时, A输出高电平B输出低电平, DI为高电平时正好相反。
5	GND	地, 电源负端
6	A	接收器同相输入端和驱动器同相输出端
7	B	接收器反相输入端和驱动器反相输出端
8	VCC	电源正端



■ 电气特性参数 (注 1)

符号	参数说明	测试条件		最小	典型	最大	单位
VIH	输入高电压	DE, RE		2	-	-	V
		DI		2.8	-	-	V
VIL	输入低电压	DE, RE		-	-	0.8	V
		DI		-	-	1.6	V
IIN1	输入电流	DE, RE, DI		-	-	±2	uA
IIN2	输入电流 (A, B)	DE=0V VCC=5V	VIN=5V	-	60	150	uA
			VIN=0V	-	180	400	
VTH	接收差分阈值电压	-		-0.2	-	0.2	V
ΔVTH	接收输入滞后	-		-	70	-	mV
VOH	接收输出高电压	IO=-4mA, VID=200mV		3.5	4.5	-	V
VOL	接收输出低电压	IO=4mA, VID=-200mV		-	0.2	0.4	V
IOZR	接收三态(高阻) 输出电流	0.4V ≤ VO ≤ 2.4V		-	-	±1	uA
RIN	接收输入阻抗	-		-	48	-	KΩ
ICC	无负载供电电流	RE, DI=0 or VCC	DE=VCC	-	1.2	1.6	mV
			DE=0	-	1.1	1.5	
IOSD1	驱动短路电流 (VO=High)	DE=RE=5V, DI=0, VA=5V		-	120	250	mA
IOSD2	驱动短路电流 (VO=Low)	DE=RE=5V, DI=0, VB=0		-	120	250	mA
IOSR	接收短路电流	0V ≤ VO ≤ VCC		-	60	100	mA
	ESD 保护	A 和 B 引脚, 使用人体模型进行测试		-	±4	-	KV

注1: 所有输入到管脚的电流为正, 所有从管脚输出的电流为负; 如无特别指出, 则电压指对地电压, TA=25℃, VCC=5V。

■ 极限参数 (注 2)

符号	参数	测试条件	最小值	典型值	最大值	单位
VCC	供电电压	-	-	-	10	V
RE, DE	控制输入电压	-	-0.5	-	+10	V
DI	驱动输入电压	-	-0.5	-	+10	V
A, B	驱动输出电压	-	-0.5	-	+15	V
A, B	接收输入电压	-	-0.5	-	+15	V
RO	接收输出电压	-	-0.5	-	+10	V
Tstg	存储温度	-	-65	-	+160	℃
TA	工作温度	-	-40	-	+85	℃

注2: 最大允许额定值是指超过这些值可能会使器件发生不可恢复的损坏。在这些条件之下是不利于器件正常运作的, 器件连续工作在最大允许额定值下可能影响器件可靠性, 所有的电压的参考点为地。



■ 电气特性参数

如无特别说明：TA=25℃，VCC=5V。

符号	参数说明	测试条件	最小	典型	最大	单位
t _{PLH}	驱动输入到输出	见图 2 RDIFP=50 Ω，CL1=CL2=100pF	40	70	90	ns
t _{PLL}			10	40	60	ns
t _{SKEW}	驱动输出压摆到输出		-	30	-	ns
t _R	驱动上升与下降时间		-	40	60	ns
t _F			-	40	60	ns
t _{PLH}	接收输入到输出	见图 2，图 4，RDIFP=50 Ω CL1=CL2=100pF	20	60	200	ns
t _{PHL}			20	40	200	ns
t _{SKD}			t _{PLH} -t _{PHL} 差分接收	-	20	-
t _{ZL}	接收使能到输出为低	见图 1，图 5，CL=15pF，S2 关闭	-	50	80	ns
t _{ZH}	接收使能到输出为高	见图 1，图 5，CL=15pF，S1 关闭	-	60	90	ns
t _{LZ}	接收从低到关闭	见图 1，图 5，CL=15pF，S2 关闭	-	50	80	ns
t _{HZ}	接收从高到关闭	见图 1，图 5，CL=15pF，S1 关闭	-	60	90	ns
f _{MAX}	最高传输速率	-	2.5			Mbps



■ 测试电路图 /Test Circuit



图1：接收器时序测试电路



图2：驱动器/接收器时序测试电路

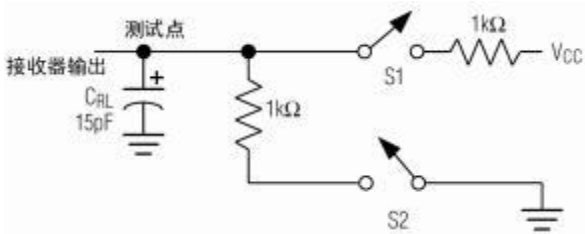

图3：接收器传输延迟测试电路

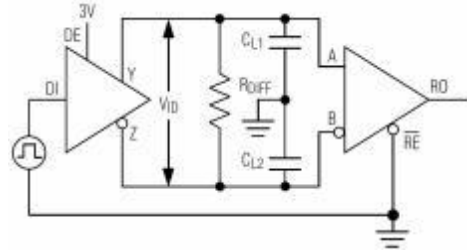

图4：接收器传输延迟

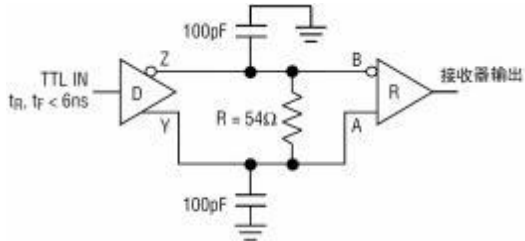

图5：接收器开启与关闭时序

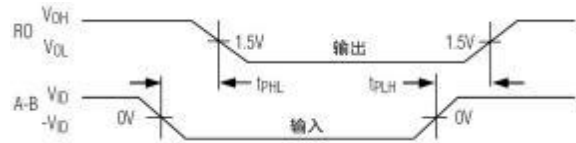

■ 功能说明 / Functional Description

● 传输距离与数据速率

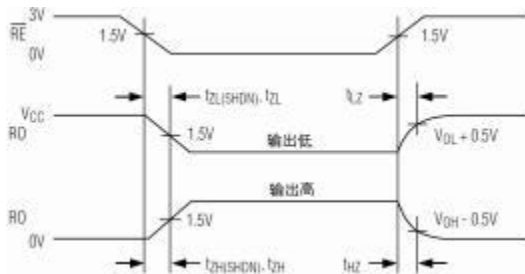
RS-485/RS-422标准覆盖最大4000英尺的传输距离。图6给出了器件以110KHz驱动4000英尺26AWG双绞线、120Ω负载时的系统差分电压。

● 驱动器输出波形

MAX485EESA发送150kHz信号时的傅里叶分析，有明显的大幅度高频谐波。如图7



图6：110KHz下驱动4000英尺电缆



图7：发送150KHz信号时的驱动器输出波形

● 驱动器输出保护

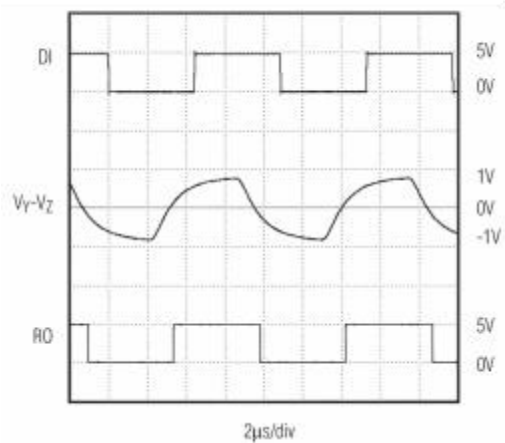
可以通过两种机制避免由故障或总线冲突引起的过高的输出电流与功耗。输出级的折返式电流限制在整个共模电压范围内提供短路保护。另外，当管芯温度上升过高时，热关断电路强制驱动器输出进入高阻态。

● 传输延时

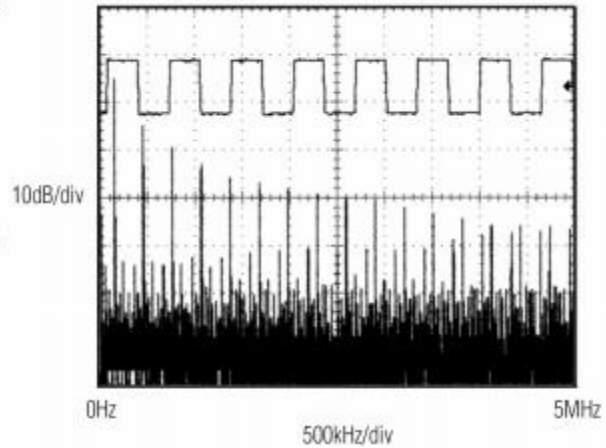
许多数字编码方案都取决于驱动器与发送器传输延时的差别。见图3、图8、图9



图8：接收器的 t_{PHL}



图9：接收器的 t_{PLH}

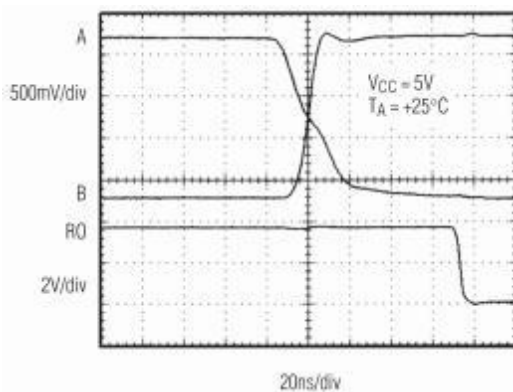

● 功能表

输入			输出
\overline{RE}	DE	A-B	RO
0	0	$\geq +0.2$	1
0	0	≤ -0.2	0
0	0	输入开路	1
1	0	X	High-Z

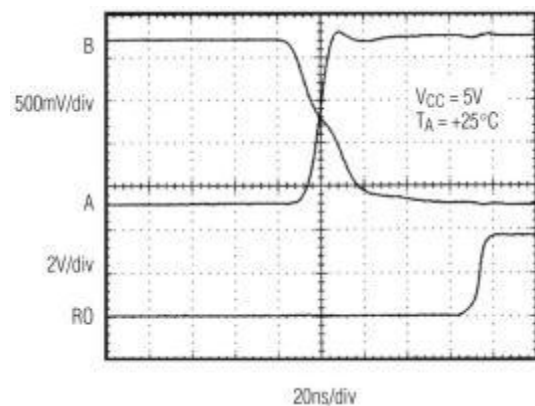
注：X=无关，High-Z=高阻



SOP-8(SOIC-8) Package Outline Dimensions

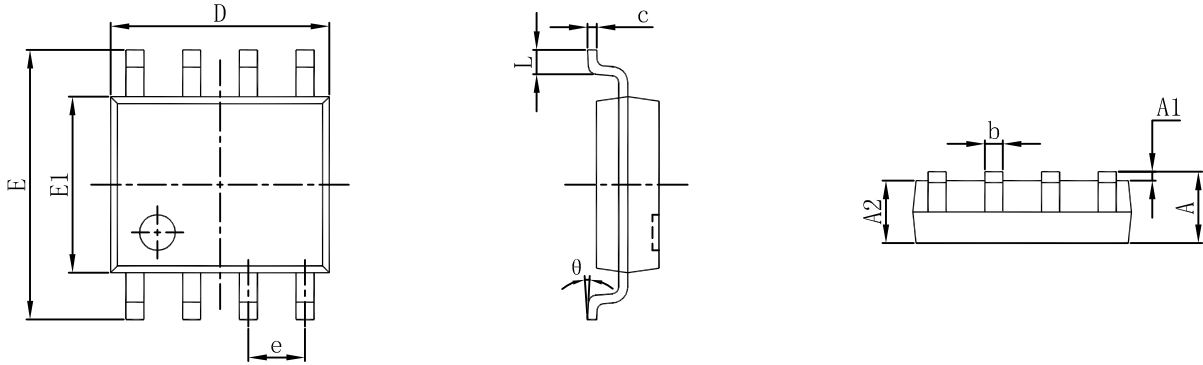

Symbol	Dimensions In Millimeters		Dimensions In Inches	
	Min	Max	Min	Max
A	1.350	1.750	0.053	0.069
A1	0.100	0.250	0.004	0.010
A2	1.350	1.550	0.053	0.061
b	0.330	0.510	0.013	0.020
c	0.170	0.250	0.007	0.010
D	4.800	5.000	0.189	0.197
e	1.270 (BSC)		0.050 (BSC)	
E	5.800	6.200	0.228	0.244
E1	3.800	4.000	0.150	0.157
L	0.400	1.270	0.016	0.050
θ	0°	8°	0°	8°

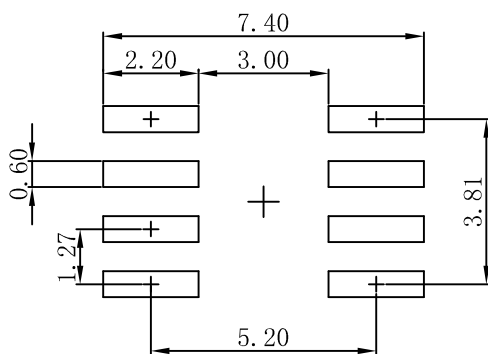

- Note:
1. Controlling dimension: in millimeters.
 2. General tolerance: $\pm 0.05\text{mm}$.
 3. The pad layout is for reference purposes only.



Attention

- Any and all HUA XUAN YANG ELECTRONICS products described or contained herein do not have specifications that can handle applications that require extremely high levels of reliability, such as life-support systems, aircraft's control systems, or other applications whose failure can be reasonably expected to result in serious physical and/or material damage. Consult with your HUA XUAN YANG ELECTRONICS representative nearest you before using any HUA XUAN YANG ELECTRONICS products described or contained herein in such applications.
- HUA XUAN YANG ELECTRONICS assumes no responsibility for equipment failures that result from using products at values that exceed, even momentarily, rated values (such as maximum ratings, operating condition ranges, or other parameters) listed in products specifications of any and all HUA XUAN YANG ELECTRONICS products described or contained herein.
- Specifications of any and all HUA XUAN YANG ELECTRONICS products described or contained herein stipulate the performance, characteristics, and functions of the described products in the independent state, and are not guarantees of the performance, characteristics, and functions of the described products as mounted in the customer's products or equipment. To verify symptoms and states that cannot be evaluated in an independent device, the customer should always evaluate and test devices mounted in the customer's products or equipment.
- HUA XUAN YANG ELECTRONICS CO.,LTD. strives to supply high-quality high-reliability products. However, any and all semiconductor products fail with some probability. It is possible that these probabilistic failures could give rise to accidents or events that could endanger human lives, that could give rise to smoke or fire, or that could cause damage to other property. When designing equipment, adopt safety measures so that these kinds of accidents or events cannot occur. Such measures include but are not limited to protective circuits and error prevention circuits for safe design, redundant design, and structural design.
- In the event that any or all HUA XUAN YANG ELECTRONICS products(including technical data, services) described or contained herein are controlled under any of applicable local export control laws and regulations, such products must not be exported without obtaining the export license from the authorities concerned in accordance with the above law.
- No part of this publication may be reproduced or transmitted in any form or by any means, electronic or mechanical, including photocopying and recording, or any information storage or retrieval system, or otherwise, without the prior written permission of HUA XUAN YANG ELECTRONICS CO.,LTD.
- Information (including circuit diagrams and circuit parameters) herein is for example only ; it is not guaranteed for volume production. HUA XUAN YANG ELECTRONICS believes information herein is accurate and reliable, but no guarantees are made or implied regarding its use or any infringements of intellectual property rights or other rights of third parties.
- Any and all information described or contained herein are subject to change without notice due to product/technology improvement, etc. When designing equipment, refer to the "Delivery Specification" for the HUA XUAN YANG ELECTRONICS product that you intend to use.