



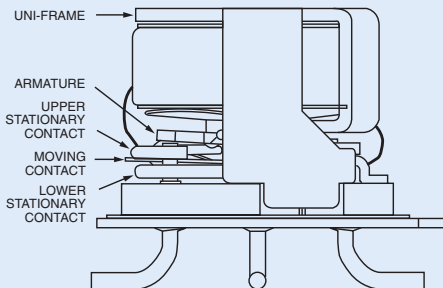
A Unit of Teledyne Electronics and Communications

# CENTIGRID® SURFACE MOUNT COMMERCIAL RELAYS DPDT

## SERIES S114

SERIES DESIGNATION	RELAY TYPE
S114	DPDT basic relay
S114D	DPDT relay with internal diode for coil transient suppression
S114DD	DPDT relay with internal diodes for coil transient suppression and polarity reversal protection

### INTERNAL CONSTRUCTION



### DESCRIPTION

The Series S114 Surface Mount Centigrid® Relay is an ultraminiature, hermetically sealed, armature relay. The low profile height (.360") and .100" lead spacing make it ideal for applications where extreme packaging density and/or close PC board spacing are required. The specially formed leads are pre-tinned to make the relays ideal for most types of surface mount solder reflow processes.

The basic design and internal construction are identical to the Series 114 Centigrid® relays, and are capable of meeting Teledyne Relays' T<sup>2</sup>R® requirements. The following unique construction features and manufacturing techniques provide overall high reliability and excellent resistance to environmental extremes:

- All welded construction.
- Unique uni-frame design providing high magnetic efficiency and mechanical rigidity.
- High force/mass ratios for resistance to shock and vibration.
- Advanced cleaning techniques provide maximum assurance of internal cleanliness.
- Precious metal alloy contact material with gold plating assures excellent high current and dry circuit switching capabilities.

### ENVIRONMENTAL AND PHYSICAL SPECIFICATIONS

<b>Temperature</b> (Ambient)	<b>Storage</b>	-65°C to +125°C
	<b>Operating</b>	-55°C to +85°C
<b>Vibration</b> (General Note 1)		30 g's to 3000 Hz
<b>Shock</b> (General Note 1)		75 g's, 6 msec, half-sine
<b>Acceleration</b>		50 g's
<b>Enclosure</b>		Hermetically sealed
<b>Weight</b>		0.07 oz. (1.9g) max.
<b>Reflow Temperature</b>		260°C max. temp. 1 min. max.

**SERIES S114**

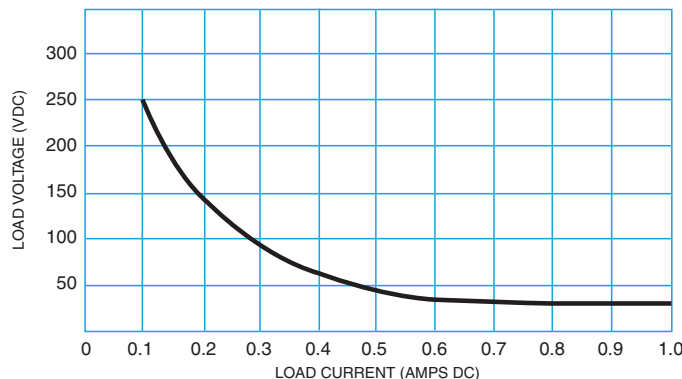
**GENERAL ELECTRICAL SPECIFICATIONS (-65°C to +125°C unless otherwise noted) (Notes 2 & 3)**

<b>Contact Arrangement</b>	2 Form C (DPDT)	
<b>Rated Duty</b>	Continuous	
<b>Contact Resistance</b>	0.1 ohm max. before life; 0.2 ohm max. after life at 1A/28Vdc (measured 1/8" from header along lead)	
<b>Contact Load Ratings (DC)</b> (See Fig. 3 for other DC resistive voltage/current ratings)	Resistive: 1 Amp/28Vdc Inductive: 200 mA/28Vdc (320 mH) Lamp: 100 mA/28Vdc Low Level: 10 to 50 µA/10 to 50mV	
<b>Contact Load Ratings (AC)</b>	Resistive: 250 mA/115Vac, 60 and 400 Hz (Case undergrounded) 100 mA/115Vac, 60 and 400 Hz (Case grounded)	
<b>Contact Life Ratings</b>	10,000,000 cycles (typical) at low level 1,000,000 cycles (typical) at 0.5A/28Vdc resistive 100,000 cycles min. at all other loads specified above	
<b>Contact Overload Rating</b>	2A/28Vdc Resistive (100 cycles min.)	
<b>Contact Carry Rating</b>	Contact factory	
<b>Coil Operating Power</b>	450 milliwatts typical at nominal rated voltage at 25°C	
<b>Operate Time</b>	2.0 msec max. at nominal rated coil voltage	
<b>Release Time</b>	S114 Series: 1.5 msec max. S114D, S114DD Series: 4.0 msec max.	
<b>Contact Bounce</b>	1.5 msec max.	
<b>Intercontact Capacitance</b>	0.4 pf typical	
<b>Insulation Resistance</b>	10,000 megohms min. between mutually isolated terminals	
<b>Dielectric Strength</b>	Atmospheric pressure: 500 Vrms/60Hz	70,000 ft.: 125 Vrms/60Hz
<b>Negative Coil Transient (Vdc)</b>	S114D, S114DD	1.0 max
<b>Diode P.I.V. (Vdc)</b>	S114D, S114DD	100 min.

**DETAILED ELECTRICAL SPECIFICATIONS (-65°C to +125°C unless otherwise noted) (Note 3)**

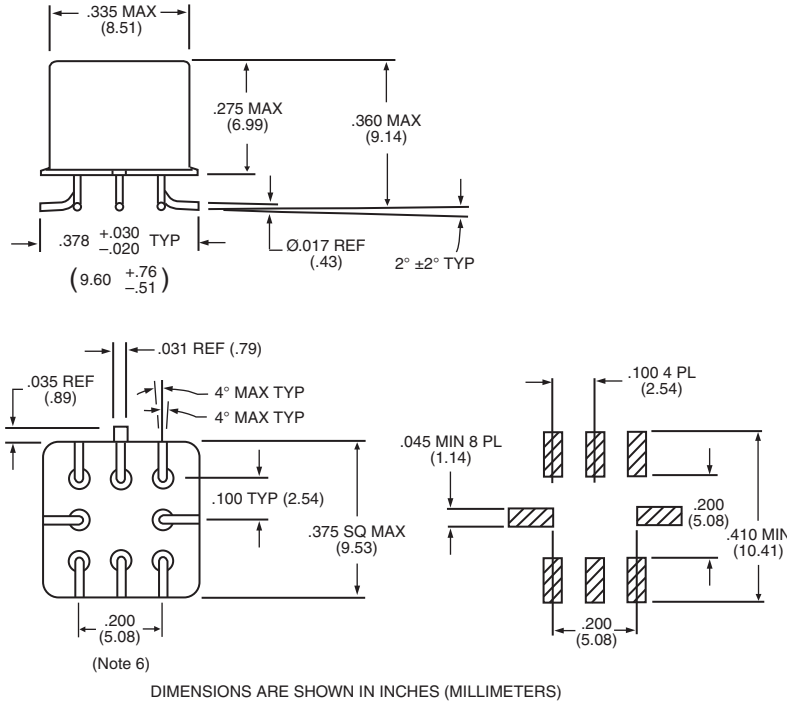
BASE PART NUMBERS (See Note 10 for full P/N example)		➔	S114-5	S114-6	S114-9	S114-12	S114-18	S114-26
			S114D-5 S114DD-5	S114D-6 S114DD-6	S114D-9 S114DD-9	S114D-12 S114DD-12	S114D-18 S114DD-18	S114D-26 S114DD-26
<b>Coil Voltage (Vdc)</b>	Nom.		5.0	6.0	9.0	12.0	18.0	26.5
	Max.		5.8	8.0	12.0	16.0	24.0	32.0
<b>Coil Resistance (Ohms ±10% @25°C)</b>	S114, 114D		50	98	220	390	880	1560
	S114DD (Note 4)		39	78	220	390	880	1560
<b>Coil Current (mAdc @25°C) (S114DD Series only)</b>	(Note 5)	Min.	93.2	57.8	33.0	25.6	17.5	14.8
		Max.	128.2	74.8	42.9	32.8	22.1	18.5
<b>Pick-up Voltage (Vdc, Max.)</b>	S114, S114D		3.5	4.5	6.8	9.0	13.5	18.0
	S114DD		4.0	5.0	7.8	10.0	14.5	19.0
<b>Drop-out Voltage (Vdc)</b>	S114, 114D	Min.	0.14	0.18	0.35	0.41	0.59	0.89
		Max.	2.3	3.2	4.9	6.5	10.0	13.0
	S114DD	Min.	0.6	0.7	0.8	0.9	1.1	1.4
		Max.	2.8	3.4	5.3	6.5	10.0	13.0

**TYPICAL DC CONTACT RATING (RESISTIVE) (Note 2)**

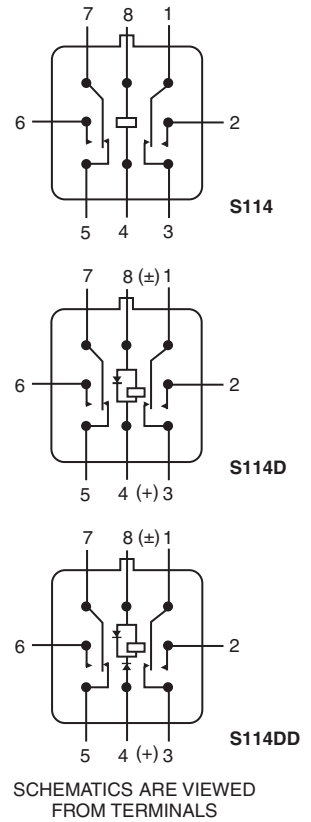


**FIGURE 1**

OUTLINE DIMENSIONS AND RECOMMENDED PAD LAYOUT (Notes 7, 8 & 9)



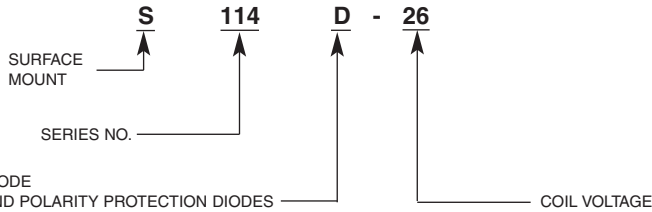
TERMINAL LOCATIONS & SCHEMATIC DIAGRAMS



GENERAL NOTES

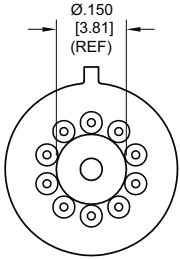
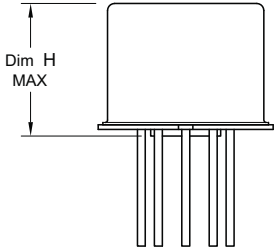
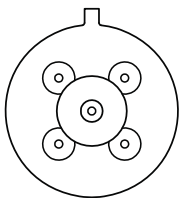
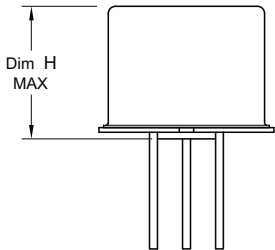
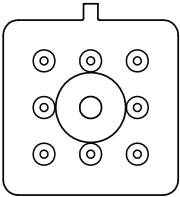
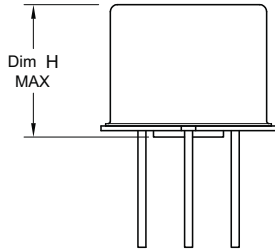
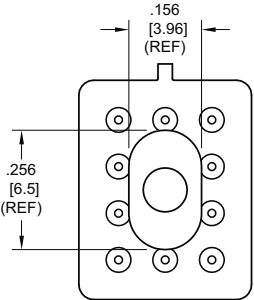
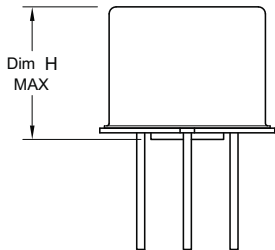
1. Relay contacts will exhibit no chatter in excess of 10 msec or transfer in excess of 1 msec.
2. "Typical" characteristics are based on available data and are best estimates. No on-going verification tests are performed.
3. Unless otherwise specified, parameters are initial values.
4. For reference only. Coil resistance not directly measurable at relay terminals due to internal series diode.
5. Measured at nominal voltage for 5 sec. max.
6. Position of leads as they emerge from relay base.
7. Leads will fit noted pad layout with no overhang.
8. Lead ends are coplanar within .008" wide tolerance zone.
9. Terminals coated with SN60 or SN63 solder per QQ-S-571. Kovar exposed at sheared end of leads.
- 10.

Teledyne Part Numbering System for Surface Mount Relays



11. Add "R" to end of part number for RoHS compliant solder coated pins (Sn99.3/Cu0.7).

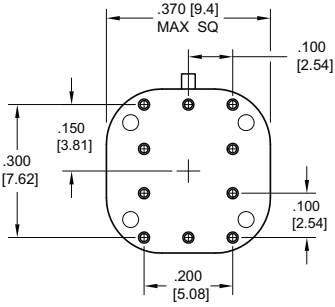
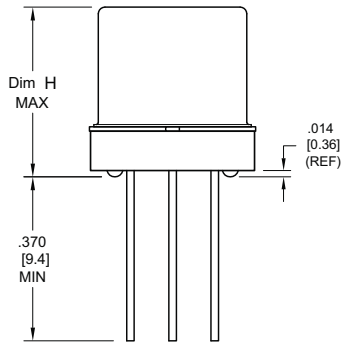
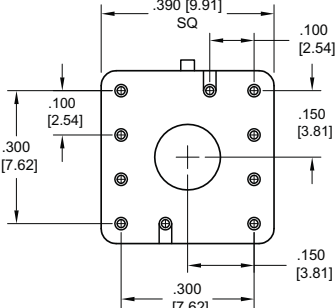
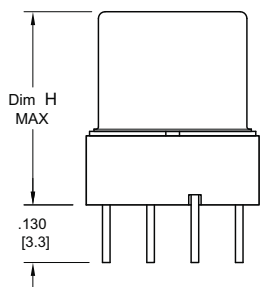
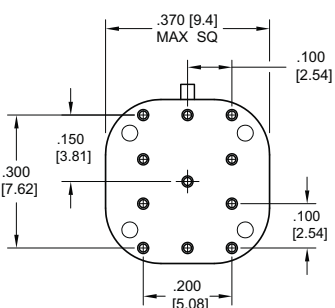
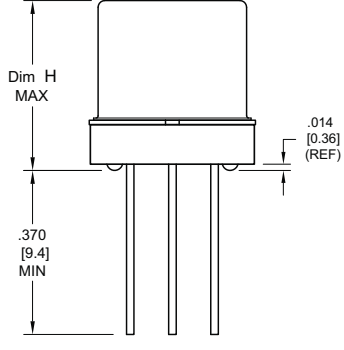
# Appendix A: Spacer Pads

Pad designation and bottom view dimensions	Height	For use with the following:	Dim. H Max.
 <p style="text-align: center;">“M4” Pad for TO-5</p>		ER411T ER412, ER412D, ER412DD	.295 (7.49)
		712, 712D, 712TN, RF300, RF310, RF320	.300 (7.62)
		ER420, ER422D, ER420DD, 421, ER421D, ER421DD, ER422, ER422D, ER422DD, 722, 722D, RF341	.305 (7.75)
		ER431T, ER432T, ER432, ER432D, ER432DD	.400 (10.16)
		732, 732D, 732TN, RF303, RF313, RF323	.410 (10.41)
		RF312	.350 (8.89)
 <p style="text-align: center;">“M4” Pad for TO-5</p>		ER411, ER411D, ER411DD	.295 (7.49)
		ER431, ER431D, ER431DD	.400 (10.16)
		RF311	.300 (7.62)
		RF331	.410 (10.41)
 <p style="text-align: center;">“M4” Pad for Centigrid®</p>		172, 172D	.305 (7.75)
		ER114, ER114D, ER114DD, J114, J114D, J114DD	.300 (7.62)
		ER134, ER134D, ER134DD, J134, J134D, J134DD	.400 (10.16)
		RF100	.315 (8.00)
		RF103	.420 (10.67)
 <p style="text-align: center;">“M9” Pad for Centigrid®</p>		122C, A152	.320 (8.13)
		ER116C, J116C	.300 (7.62)
		ER136C, J136C	.400 (10.16)
		RF180	.325 (8.25)
		A150	.305 (7.75)

**Notes:**

1. Spacer pad material: Polyester film.
2. To specify an “M4” or “M9” spacer pad, refer to the mounting variants portion of the part numbering example in the applicable datasheet.
3. Dimensions are in inches (mm).
4. Unless otherwise specified, tolerance is  $\pm .010$  (.25).
5. Add 10 m $\Omega$  to the contact resistance show in the datasheet.
6. Add 0.01 oz. (0.25 g) to the weight of the relay assembly shown in the datasheet.

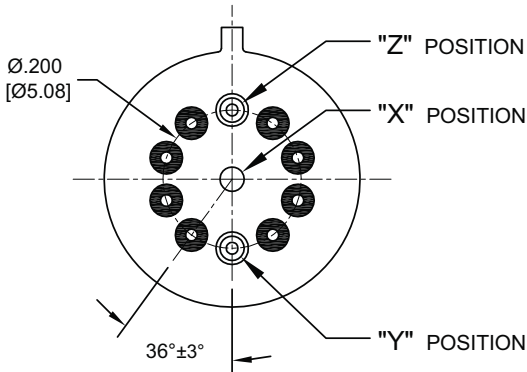
# Appendix A: Spreader Pads

Pad designation and bottom view dimensions	Height	For use with the following:	Dim. H Max.
 <p>"M" Pad <u>5/</u> <u>6/</u> <u>9/</u></p>		ER411T, J411T, ER412, ER412D ER412DD, J412, J412D, J412DD ER412T, J412T	.388 (9.86)
		712, 712D, 712TN	.393 (9.99)
		ER431T, J431T, ER432, ER432D ER432DD, J432, J432D, J432DD ER432T, J432T	.493 (12.52)
		732, 732D, 732TN	.503 (12.78)
		ER420, J420, ER420D, J420D ER420DD, J420DD, ER421, J421 ER421D, J421D, ER421DD J422D, ER422DD, J422DD, 722	.398 (10.11)
 <p>"M2" Pad <u>7/</u> <u>8/</u></p>		ER411T ER412, ER412D, ER412DD J412, J412D, J412DD	.441 (11.20)
		712, 712D	.451 (11.46)
		ER421, ER421D, ER421DD 722, 732D	.451 (11.46)
		ER431T ER432, ER432D, ER432DD	.546 (13.87)
		732, 732D	.556 (14.12)
 <p>"M3" Pad <u>5/</u> <u>6/</u> <u>9/</u></p>		ER411, ER411D, ER411DD ER411TX ER412X, ER412DX, ER412DDX ER412TX	.388 (9.86)
		712X, 712DX, 712TNX	.393 (9.99)
		ER420X, ER420DX, ER420DDX ER421X, ER421DX, ER421DDX ER422X, ER422DX ER422DDX, 722X, 722DDX	.398 (10.11)
		ER431, ER431D, ER431DD ER431TX ER432X, ER432DX, ER432DDX ER432TX	.493 (12.52)
		732X, 732DX, 732TNX	.503 (12.78)

**Notes:**

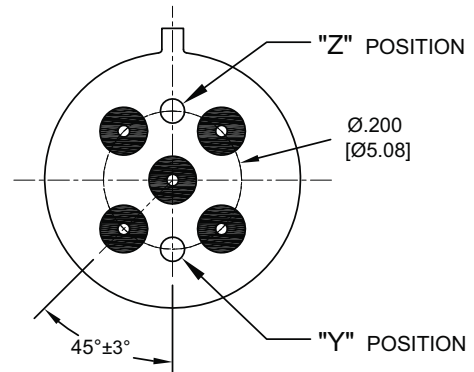
1. Spreader pad material: Diallyl Phthalate.
2. To specify an "M", "M2" or "M3" spreader pad, refer to the mounting variants portion of the part number example in the applicable datasheet.
3. Dimensions are in inches (mm).
4. Unless otherwise specified, tolerance is  $\pm .010$ " (0.25).
- 5/. Add 25 m $\Omega$  to the contact resistance shown in the datasheet.
- 6/. Add .01 oz. (0.25 g) to the weight of the relay assembly shown in the datasheet.
- 7/. Add 50 m $\Omega$  to the contact resistance shown in the datasheet.
- 8/. Add 0.025 oz (0.71 g) to the weight of the relay assembly shown in the datasheet.
- 9/. M3 pad to be used only when the relay has a center pin (e.g. ER411M3-12A, 722XM3-26.)

# Appendix A: Ground Pin Positions



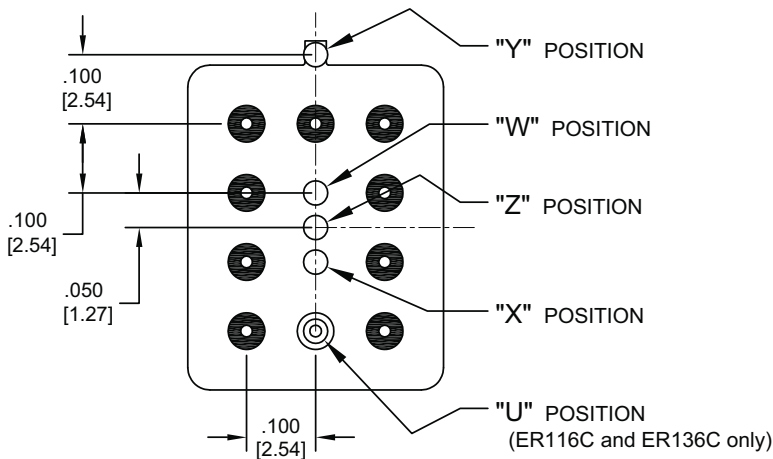
### TO-5 Relays:

ER411T, ER412, ER412T, ER420, ER421, ER422,  
ER431T, ER432, ER432T, 712, 712TN, 400H, 400K,  
400V, RF300, RF303, RF341, RF312, RF310, RF313,  
RF320, RF323



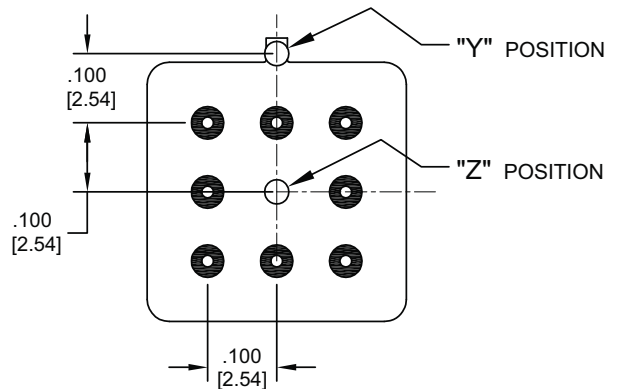
### TO-5 Relays:

ER411, ER431, RF311, RF331



### Centigrid® Relays:

RF180, ER116C, 122C, ER136C



### Centigrid® Relays:

RF100, RF103, ER114, ER134, 172

- Indicates ground pin position
- Indicates glass insulated lead position
- ⊙ Indicates ground pin or lead position depending on relay type

### NOTES

1. Terminal views shown
2. Dimensions are in inches (mm)
3. Tolerances:  $\pm .010$  ( $\pm .25$ ) unless otherwise specified
4. Ground pin positions are within  $.015$  ( $0.38$ ) dia. of true position
5. Ground pin head dia.,  $0.035$  ( $0.89$ ) ref: height  $0.010$  ( $0.25$ ) ref.
6. Lead dia.  $0.017$  ( $0.43$ ) nom.

# Mouser Electronics

Authorized Distributor

Click to View Pricing, Inventory, Delivery & Lifecycle Information:

## Teledyne Relays:

[S114-26](#) [S114-5](#) [S114D-12](#) [S114D-26](#) [S114D-5](#) [S114DD-5](#) [S114D](#)