



# 承 认 书

## Specification for approval

CUSTOMER NAME 客户名称:

DIRECTOR 经办者:

PART NO. 料号: E6C0606RGBC3UDA

PART NUMBER 品名: 0606 RGB

ISSUE DATE 发件日期: 2018-02-02



### 客户承认签章

### Customer confirm and sign

检 查 TESTED BY	核 对 CHECKED BY	承 认 APPROVED BY

审 核 结 果 INSPECT RESULT	合 格 ACCEPT	不 合 格 REJECT
---------------------------	---------------	-----------------

REMARK 说明:



Features 产品特点:

- Long operating life 使用寿命长
- Low Power Consumption 低功耗
- Wide Viewing Angle 宽视角
- RoHS Compliant 通过无铅认证



Application 适用范围:

- Backlight 背光源
- Decoration lighting 装饰光源
- motormeter 汽车仪表光源
- Indicator 指示光源

Part Number 产品型号	Dice Material 芯片材质	Emitted Color 发光颜色	Lens Color 胶体颜色
E6C0606RGBC3UDA	AlGaInP-InGaN-InGaN	Red-Green-Blue	Water Clear

Electro-Optical Characteristics(Ta=25°C, @20mA)光电参数

Parameter 参数	Symbol 符号	Min.最小值	Typ. 中间值	Max. 最大值	Unit 单位
Luminous Intensity 亮度	IV	R:70	100	150	mcd
		G:400	500	600	mcd
		B:70	100	150	mcd
Dominant Wavelength 主波长	λd	R:617	625	630	nm
		G:517	525	530	nm
		B:460	465	475	nm
Forward Voltage 电压	VF	R:1.90	2.00	2.40	v
		G:2.80	3.00	3.40	v
		B:2.80	3.00	3.40	v
Viewing Angle 发光角度	2θ1/2	-	120	-	deg
Reverse Current 反向电流	IR	-	-	10	uA

Absolute Maximum Ratings(Ta=25°C)绝对最大额定值

Parameter 参数	Symbol 符号	Max.最大值	Unit 单位
Peak Forward Current(1/10 Duty Cycle, 0.1ms Pulse Width)峰值正向电流 (1/10 的占空比, 0.1ms 脉冲宽度)	IPF	100	mA
Forward Current 正向电流	IF	30	mA
Reverse Voltage 反向电压	VR	5	v
Electrostatic Discharge 抗静电能力	ESD	2000	v
Operating Temperature Range 工作温度	Topr	-40to+90	°C
Storage Temperature Range 储存温度	Tstg	-40to+90	°C
Reflow Soldering 焊接温度	Tsld	260°C for 10secs	



### Optical & Electrical Characteristics 光电特性

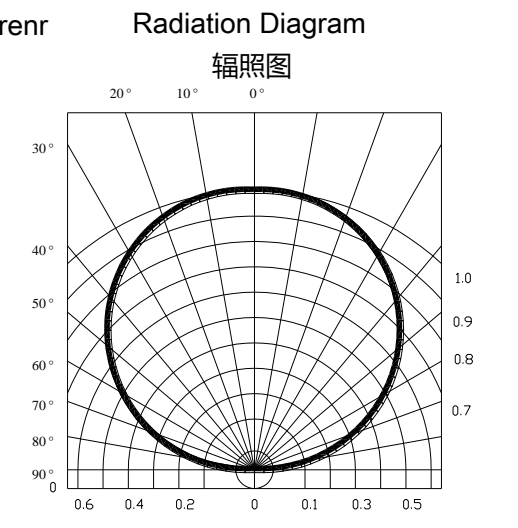
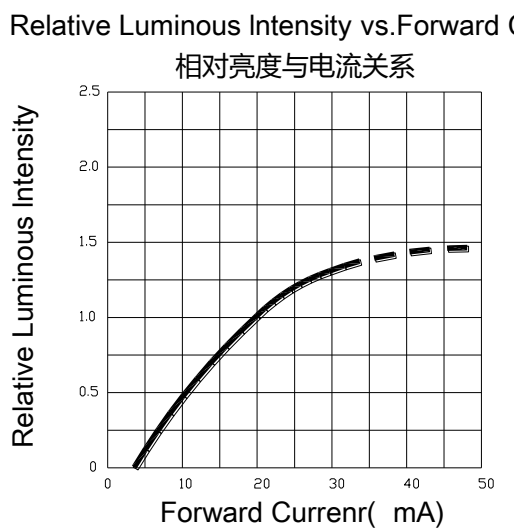
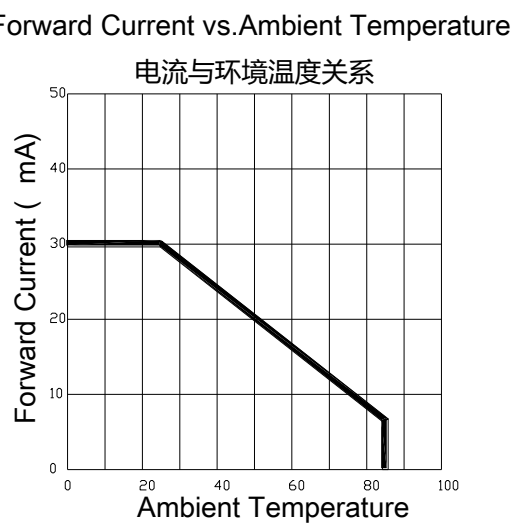
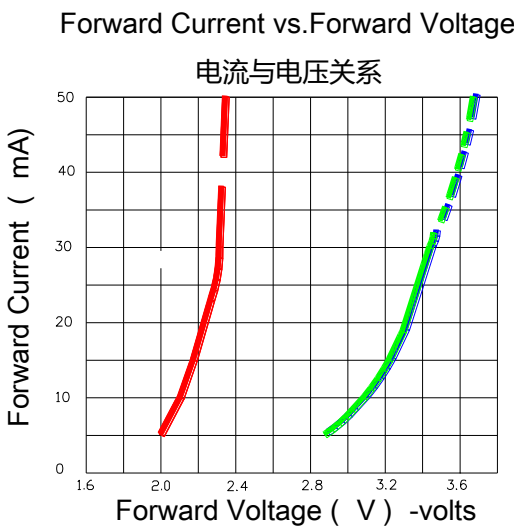
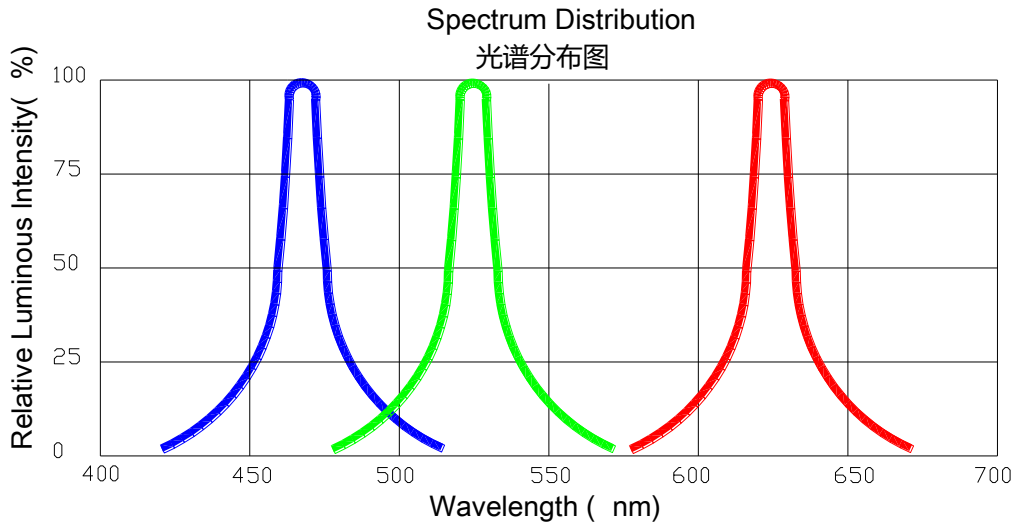



### Reliability Test Items And Conditions 可靠性实验

实验项目 Test Items	参考标准 Reference	实验条件 Test Conditions	时间 Time	样品数 Quantity	判据 Criterion
冷热冲击 Thermal Shock	MIL-STD-202G	-40°C (30min) ~100°C (30min)	100循环 100 Cycles	22	0/22
湿热循环 Temperature And Humidity Cyclic	JEITA ED-4701 200 203	-10°C~65°C ; 0%~90%RH	10循环 10cycles	22	0/22
高温储存 High Temperature Storage	JEITA ED -4071 200 201	Ta=100°C	1000H	22	0/22
低温储存 Low Temperature Storage	JEITA ED -4071 200 202	Ta=-40°C	1000H	22	0/22
高温高湿储存 High Temperature High Humidity Storage	JEITA ED -4071 100 103	Ta=60°C ; RH=90%	1000H	22	0/22
高温寿命 High Temperature Life Test	JESD22-A108D	Ta=80°C	1000H	22	0/22
常温寿命试验 Life Test	JESD22-A108D	Ta=25°C IF=20mA	1000H	22	0/22
耐焊性 Resistance to Soldering Heat	GB/T 4937, II , 2.2&2.3	Tsol*=(240±5)°C 10secs	2次 2 times	22	0/22

### Criteria For Judging Damage 失效判断标准

测试项目 Test Items	符号 Symbol	测试条件 Test Conditions	判定标准 Criteria For Judging Damage
正向电压 Forward Voltage	V <sub>F</sub>	I <sub>F</sub> =I <sub>FT</sub>	初始值±10% Initial Data±10%
反向电流 Reverse Current	I <sub>R</sub>	V <sub>R</sub> =5V	I <sub>R</sub> ≤10uA
光强 Luminous Intensity	I <sub>V</sub>	I <sub>F</sub> =I <sub>FT</sub>	平均I <sub>V</sub> 衰减≤30% ; 单个I <sub>V</sub> 衰减≤50% Average I <sub>V</sub> degradation≤30% ; Single LED I <sub>V</sub> degradation≤50%
耐焊性 Resistance to Soldering Heat			材料内部无裂痕、无材料间爆裂、剥离、无死灯 Material without internal cracks, no material between stripped, no dead light



### Product size产品尺寸 (Unit : mm)

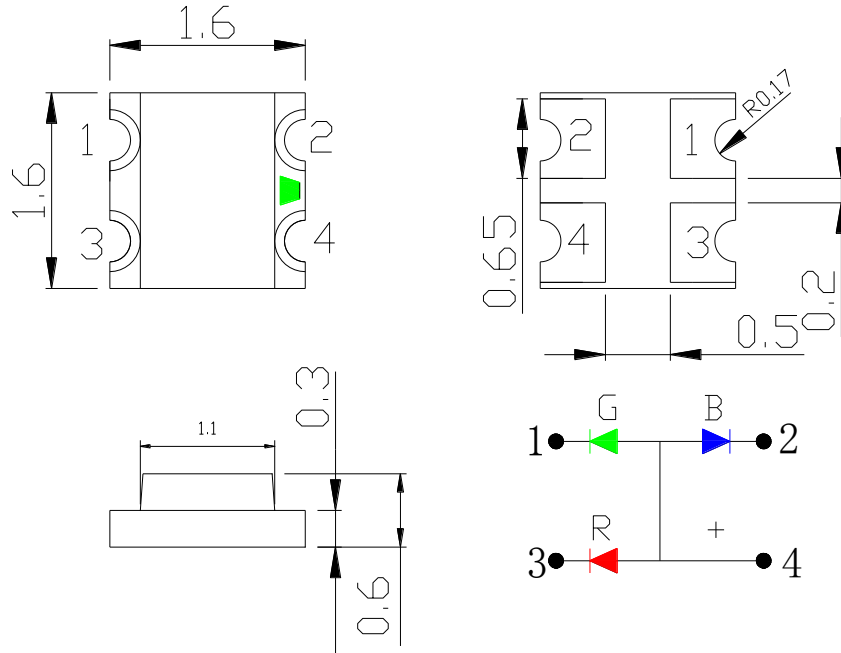

### NOTES 注释 :

1. All dimensions are in millimeters (inches)所有的尺寸均以毫米(英寸)
2. Tolerances are  $\pm 0.2\text{mm}$  (0.008inch) unless otherwise noted。除非另有注明;公差是0.2毫米(0.008英寸)

### Recommended Soldering Pad Design推荐焊盘设计(Unit : mm)

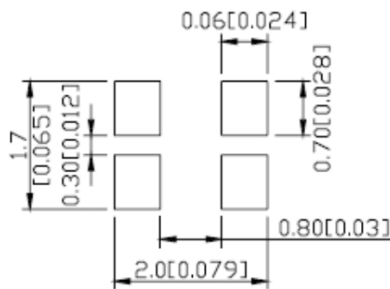

### Taping and package Spec编带和包装规格

- Tape Specification: 3,000pcs Per Reel 编带包装3000PCS/卷

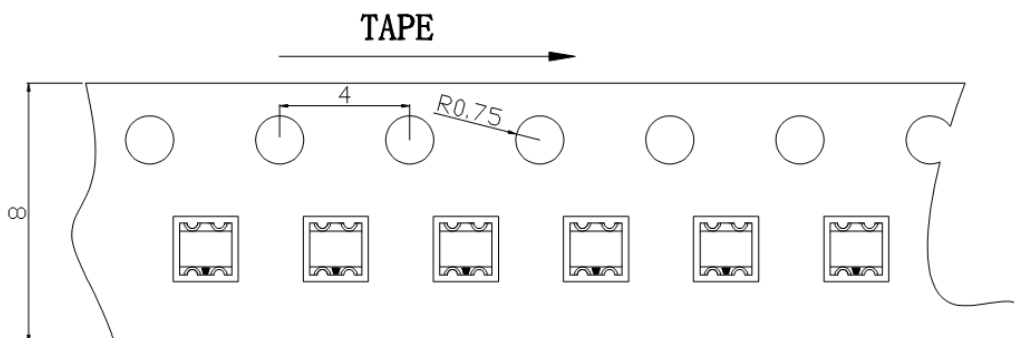



### Packaging 包装规格

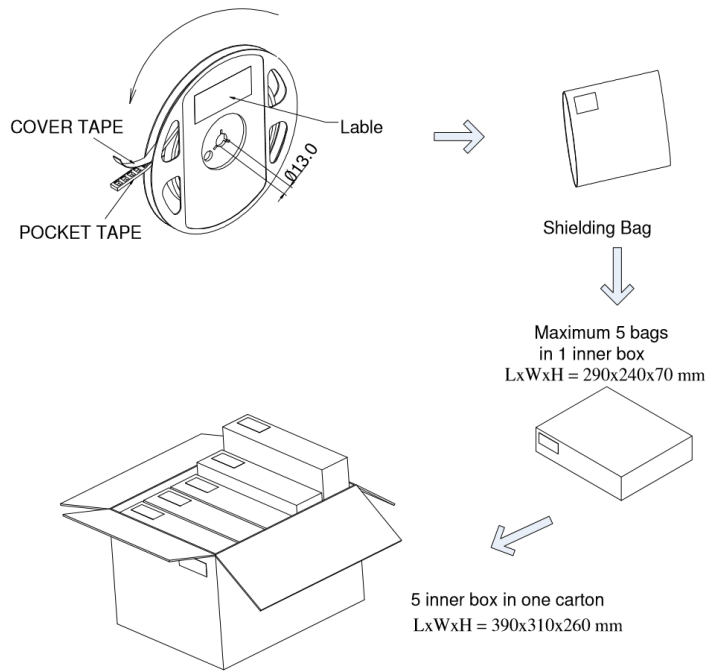

### LabelStyle 标签样式

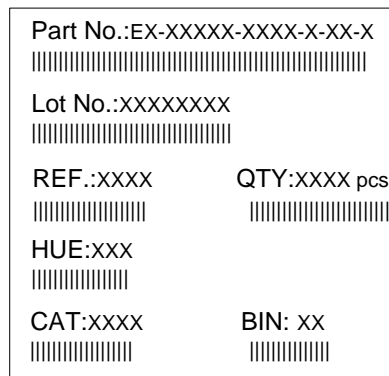

Part No:产品型号  
 Lot No:生产批次  
 QTY: 数量  
 REF: 电压  
 HUE:波长或色区  
 CAT:亮度  
 BIN:分选等级



### Useful hint 产品使用说明

### Reflow Soldering Instructions 回流焊说明

Lead Solder 有铅回焊

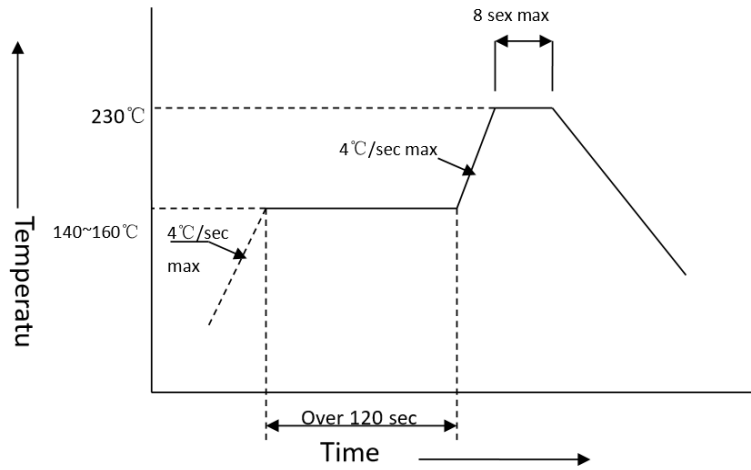

Lead-Free Solder 无铅回焊

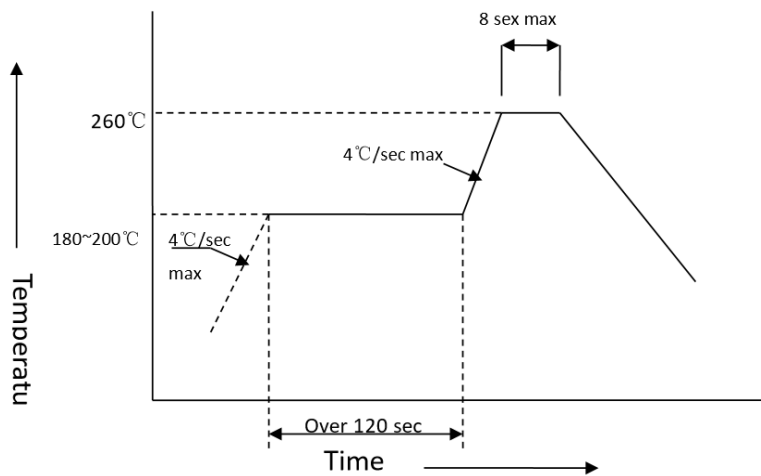

- 回流焊最多只能进行两次。

Reflow soldering should not be done more than two times

- 在回流焊升温过程中，请不要对 LED 施加任何压力。

Stress on the LEDs should be avoided during heating in soldering process

- 在焊接完成后，待产品温度下降到室温之后，再进行其它处理。

After soldering, do not deal with the product before its temperature drop down to room Temperature.



## Precautions 使用注意事项

### 1. Storage 贮存:

- 本产品使用密封防潮防静电袋包装，并附有干燥剂，未开封的产品有一年的保存时间。

Moisture proof and anti-electrostatic package with moisture absorbent material is used, to keep moisture to a minimum.

- 开封前，产品须存放在温度不高于 30°C，湿度不高于 60%RH 的环境中。

Before opening the package, the product should be kept at 30°C or less and humidity less than 60% RH, and be used within a year.

- 开封后，产品须存放在温度不高于 30°C，湿度不高于 10%RH 的环境中，且应该在 24 小时（1 天）内使用完。建议工作环境为温度不高于 30°C，湿度不高于 60%RH。

After opening the package, the product should be stored at 30°C or less and humidity less than 10%RH, and be soldered within 24 hours (1 day). It is recommended that the product be operated at the workshop condition of 30°C or less and humidity less than 60%RH.

- 对于尚未焊接的 LED，如果吸湿剂或包装失效，或者产品没有符合以上有效存储条件，烘焙可以起到一定的性能恢复效果。烘焙条件：(70±5) °C，持续 24 小时。

If the moisture absorbent material has faded away or the LEDs have exceeded the storage time, baking treatment should be performed based on the following condition: (70±5)°C for 24 hours.

### 2. Static Electricity 静电:

静电和电涌会导致产品特性发生改变，例如正向电压降低等，如果情况严重甚至会损毁产品。所以在使用时必须采取有效的防静电措施。

所有相关的设备和机器都应该正确接地，同时必须采取其他防止静电和电涌的措施。

使用防静电手环，防静电垫子，防静电工作服、工作鞋、手套，防静电容器，都是有效的防止静电和电涌的措施。

Static electricity or surge voltage damages the LEDs. Damaged LEDs will show some unusual characteristic such as the forward voltage becomes lower, or the LEDs do not light at the low current. even not light.

All devices, equipment and machinery must be properly grounded. At the same time, it is recommended that wrist bands or anti-electrostatic gloves, anti-electrostatic containers be used when dealing with the LEDs.

### 3. Vulcanization 硫化:

LED 硫化是由于环境中的硫进入支架内部与 +1 价的银发生化学反应生成黑色 Ag<sub>2</sub>S 的过程。该过程会导致支架镀银层的反光能力下降，色温漂移和光衰严重，很大程度上影响了产品性能。因此，在使用时应注意采取相应的防硫措施，如避免使用挥发性强的含硫物质，避免接触含硫较高的物质。

LED curing is due to sulfur being in bracket and the +1 price of silver in the chemical reaction generated Ag<sub>2</sub>S in the process. It will lead to the capacity of reflecting of silver layer reducing, light color temperature drift and serious decline, seriously affecting the performance of the product. So we should take corresponding measures to avoid vulcanization, such as to avoid using sulphur volatile substances and keeping away from high sulphur content of the material.