

P-Channel 30-V(D-S) MOSFET

$V_{(BR)DSS}$	$R_{DS(on)MAX}$	I_D
-30V	0.060Ω@-10V	-4.0A
	0.070Ω@-4.5V	
	0.100Ω@-2.5V	

General FEATURE

- TrenchFET Power MOSFET
- Lead free product is acquired
- Surface mount package

APPLICATION

- Load Switch for Portable Devices
- DC/DC Converter

SOT-23

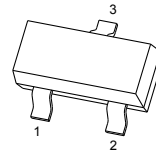

- 1.GATE
- 2.SOURCE
- 3.DRAIN

MARKING

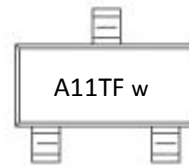

*w: week code

Equivalent Circuit

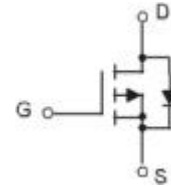

Maximum ratings ($T_a=25^\circ\text{C}$ unless otherwise noted)

Parameter	Symbol	Value	Unit
Drain-Source Voltage	V_{DS}	-30	V
Gate-Source Voltage	V_{GS}	±12	
Continuous Drain Current	I_D	-4.0	A
Pulsed Drain Current	I_{DM}	-25	
Maximum Power Dissipation	P_D	1.2	W
Thermal Resistance from Junction to Ambient($t \leq 5s$)	$R_{\theta JA}$	104	$^\circ\text{C/W}$
Junction Temperature	T_J	150	$^\circ\text{C}$
Storage Temperature	T_{stg}	-55 ~+150	

MOSFET ELECTRICAL CHARACTERISTICS

T_a =25 °C unless otherwise specified

Parameter	Symbol	Test Condition	Min	Typ	Max	Units
Static characteristics						
Drain-source breakdown voltage	BV _{DSS}	V _{GS} = 0V, I _D = -250μA	-30			V
Zero gate voltage drain current	I _{DSS}	V _{DS} = -24V, V _{GS} = 0V			-1	μA
Gate-source leakage current	I _{GSS}	V _{GS} = ±12V, V _{DS} = 0V			±100	nA
Drain-source on-resistance (note a)	R _{DS(on)}	V _{GS} = -10V, I _D = -4.0A		55	60	mΩ
		V _{GS} = -4.5V, I _D = -3.5A		65	70	mΩ
		V _{GS} = -2.5V, I _D = -1.2A		95	100	mΩ
Forward tranconductance (note a)	g _{FS}	V _{DS} = -5V, I _D = -4.0A	7	10		S
Gate threshold voltage	V _{GS(th)}	V _{DS} = V _{GS} , I _D = -250μA	-0.6	-1	-1.2	V
Diode forward voltage (note a)	V _{SD}	I _S = -1A, V _{GS} = 0V			-1.2	V
Dynamic characteristics (note b)						
Input capacitance	C _{iss}	V _{DS} = -15V, V _{GS} = 0V, f = 1MHz		950		pF
Output capacitance	C _{oss}			115		pF
Reverse transfer capacitance	C _{rss}			75		pF
Switching Characteristics (note b)						
Turn-on delay time	t _{d(on)}	V _{GS} = -10V, V _{DS} = -15V, I _D = -4.0A, R _{GEN} = 6Ω		7.0		ns
Turn-on rise time	t _r			3.0		ns
Turn-off delay time	t _{d(off)}			30		ns
Turn-off fall time	t _f			12		ns

Notes:

- a. Pulse Test : Pulse Width < 300μs, Duty Cycle ≤2%.
b. These parameters have no way to verify.

Typical Electrical and Thermal Characteristics

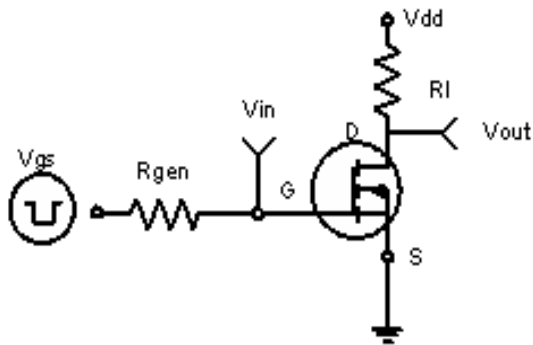

Figure 1: Switching Test Circuit

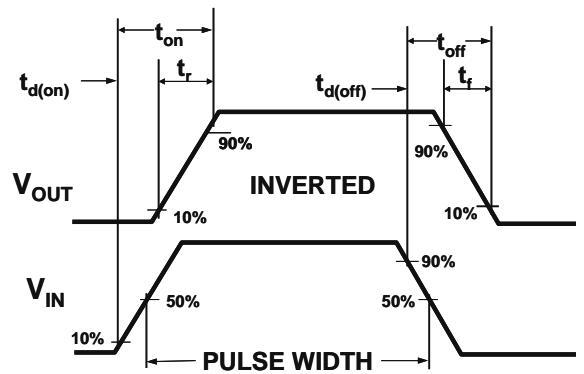

Figure 2: Switching Waveforms

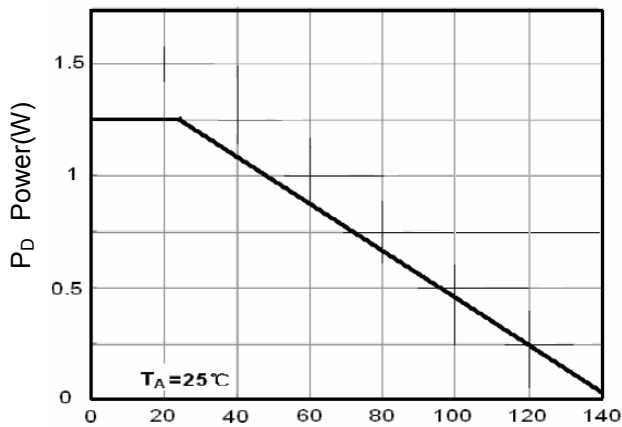

Figure 3 Power Dissipation

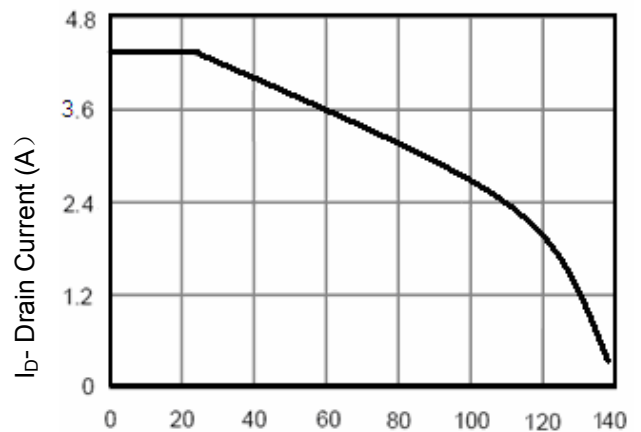

Figure 4 Drain Current

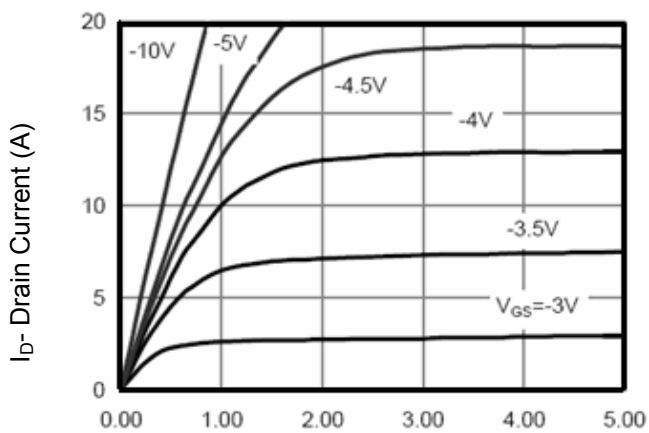

Figure 5 Output Characteristics

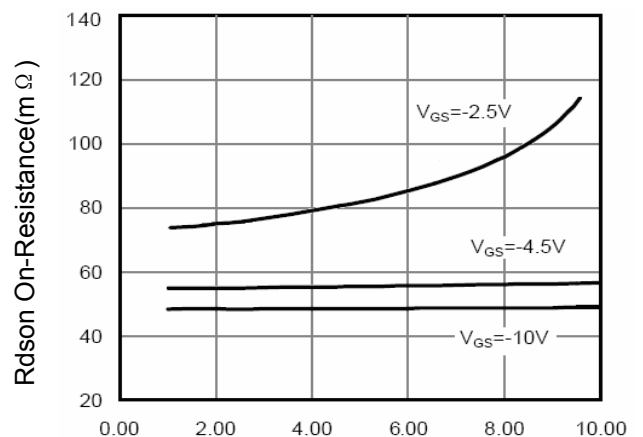

Figure 6 Drain-Source On-Resistance

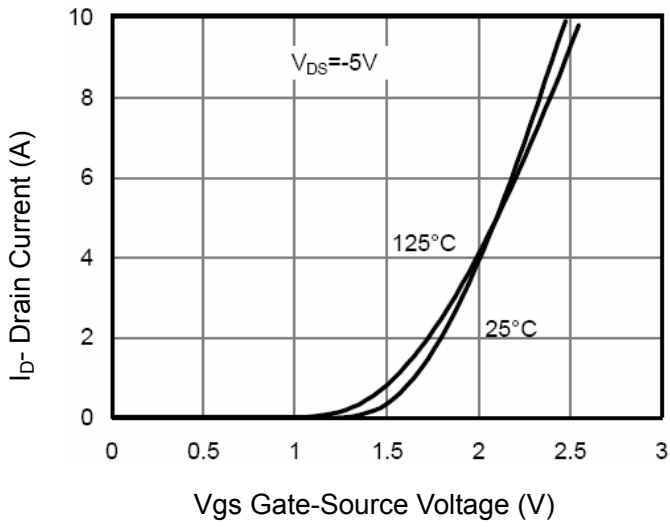

Figure 7 Transfer Characteristics

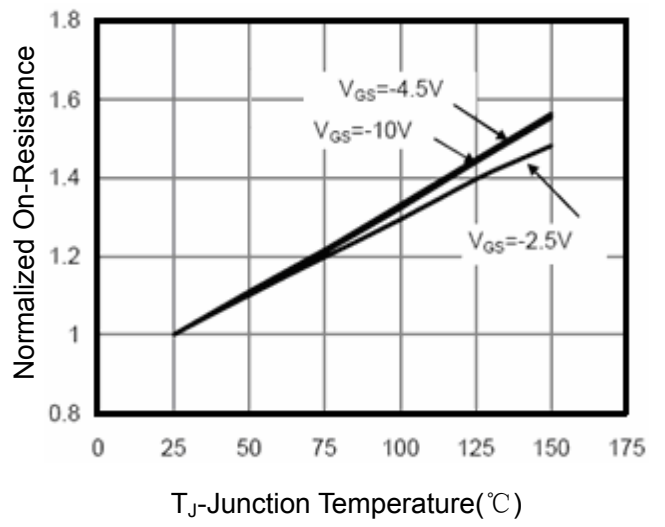

Figure 8 Drain-Source On-Resistance

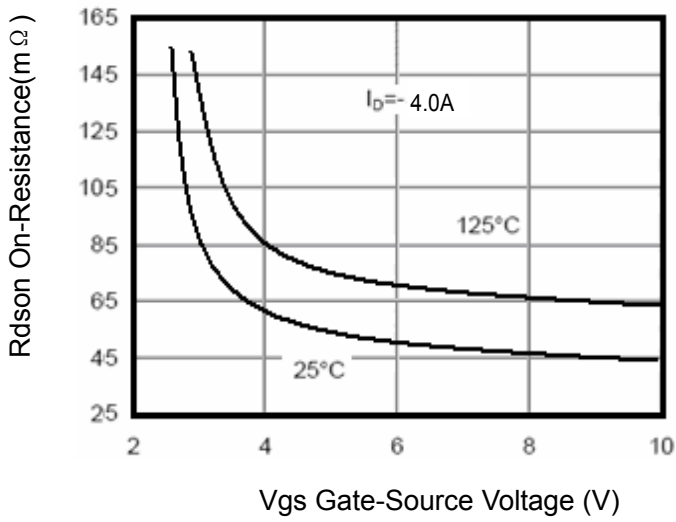

Figure 9 $R_{DS(on)}$ vs V_{GS}

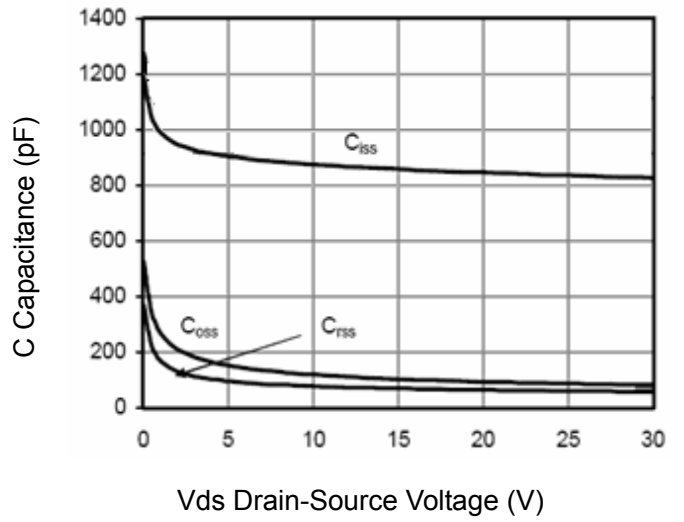

Figure 10 Capacitance vs V_{DS}

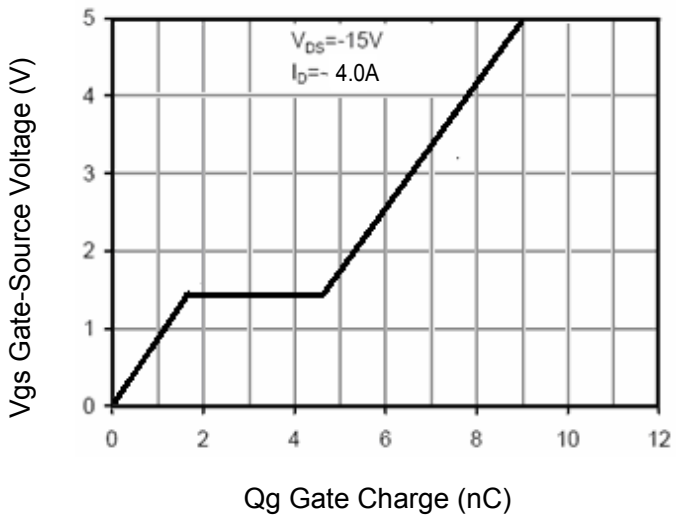

Figure 11 Gate Charge

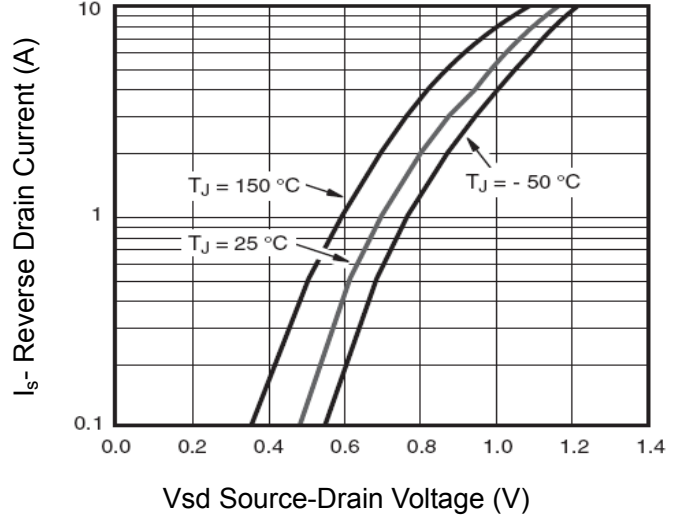
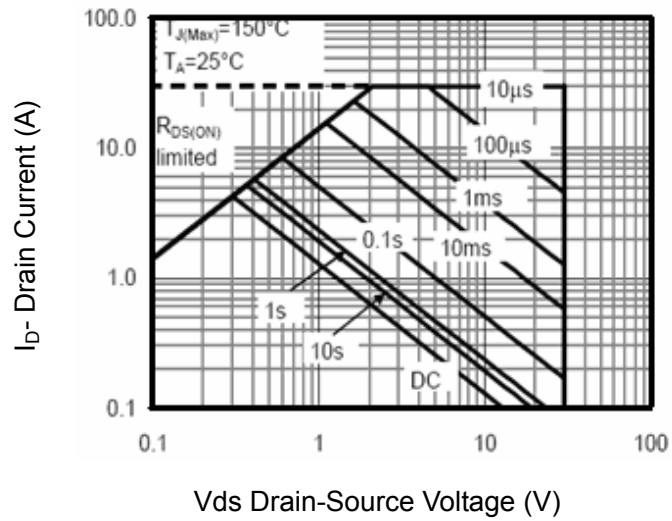

Figure 12 Source-Drain Diode Forward



Vds Drain-Source Voltage (V)
Figure 13 Safe Operation Area

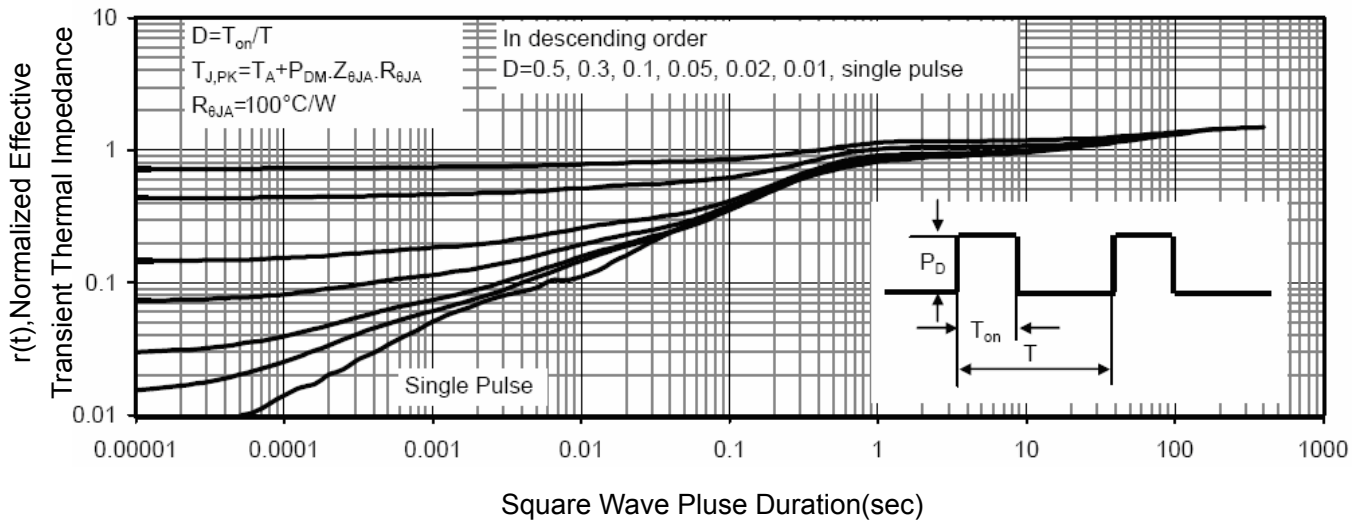
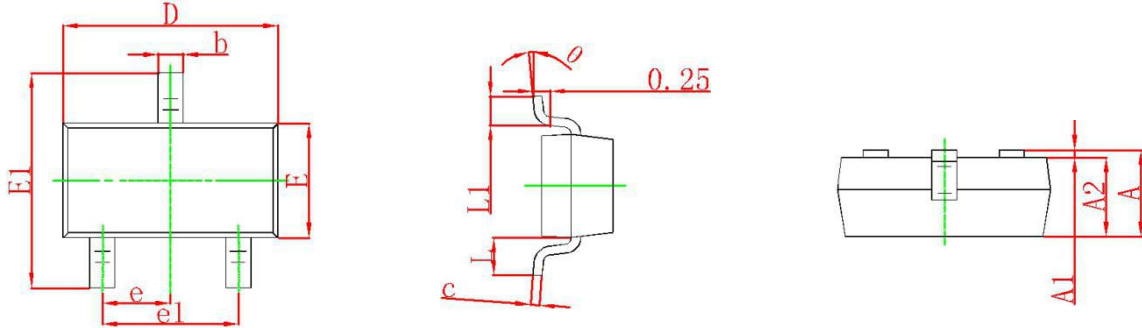

Figure 14 Normalized Maximum Transient Thermal Impedance

SOT-23 Package Outline Dimensions



Symbol	Dimensions In Millimeters		Dimensions In Inches	
	Min	Max	Min	Max
A	0.900	1.150	0.035	0.045
A1	0.000	0.100	0.000	0.004
A2	0.900	1.050	0.035	0.041
b	0.300	0.500	0.012	0.020
c	0.080	0.150	0.003	0.006
D	2.800	3.000	0.110	0.118
E	1.200	1.400	0.047	0.055
E1	2.250	2.550	0.089	0.100
e	0.950 TYP		0.037 TYP	
e1	1.800	2.000	0.071	0.079
L	0.550 REF		0.022 REF	
L1	0.300	0.500	0.012	0.020
θ	0°	8°	0°	8°

SOT-23 Suggested Pad Layout

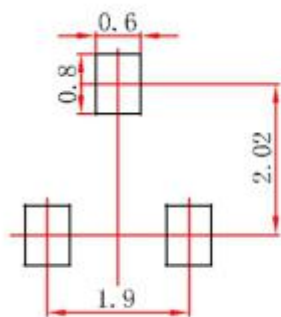

- Note:
1. Controlling dimension: in millimeters.
 2. General tolerance: $\pm 0.05\text{mm}$.
 3. The pad layout is for reference purposes only.