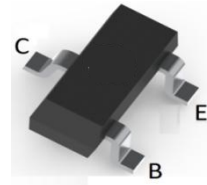
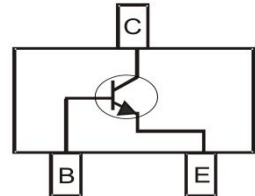

BIPOLAR TRANSISTOR (NPN)
FEATURES

- Complementary to S8550
- Excellent h_{FE} Linearity
- High Collector Current
- Surface Mount device

SOT-23

MECHANICAL DATA

- Case: SOT-23
- Case Material: Molded Plastic. UL flammability
- Classification Rating: 94V-0
- Weight: 0.008 grams (approximate)

MAXIMUM RATINGS ($T_A = 25^\circ\text{C}$ unless otherwise noted)

Parameter	Symbol	Value	Unit
Collector-Base Voltage	V_{CB0}	40	V
Collector-Emitter Voltage	V_{CEO}	25	V
Emitter-Base Voltage	V_{EBO}	5	V
Collector Current	I_C	500	mA
Collector Power Dissipation	P_C	300	mW
Thermal Resistance From Junction To Ambient	$R_{\theta JA}$	417	$^\circ\text{C}/\text{W}$
Junction Temperature	T_J	150	$^\circ\text{C}$
Storage Temperature	T_{STG}	-55 ~+150	$^\circ\text{C}$

ELECTRICAL CHARACTERISTICS ($T_A = 25^\circ\text{C}$ unless otherwise specified)

Parameter	Symbol	Min	Typ	Max	Unit	Conditions
Collector-base breakdown voltage	$V_{(BR)CB0}$	40			V	$I_C=100\mu\text{A}$, $I_E=0$
Collector-emitter breakdown voltage	$V_{(BR)CEO}$	25			V	$I_C=1\text{mA}$, $I_B=0$
Emitter-base breakdown voltage	$V_{(BR)EBO}$	5			V	$I_E=100\mu\text{A}$, $I_C=0$
Collector cut-off current	I_{CBO}			0.1	μA	$V_{CB}=40\text{V}$, $I_E=0$
Collector cut-off current	I_{CEO}			0.1	μA	$V_{CE}=20\text{V}$, $I_B=0$
Emitter cut-off current	I_{EBO}			0.1	μA	$V_{EB}=5\text{V}$, $I_C=0$
DC current gain	h_{FE1}	120		400		$V_{CE}=1\text{V}$, $I_C=50\text{mA}$
	h_{FE2}	50				$V_{CE}=1\text{V}$, $I_C=500\text{mA}$
Collector-emitter saturation voltage	$V_{CE(sat)}$			0.6	V	$I_C=500\text{mA}$, $I_B=50\text{mA}$
Base-emitter saturation voltage	$V_{BE(sat)}$			1.2	V	$I_C=500\text{mA}$, $I_B=50\text{mA}$
Transition frequency	f_T	150			MHz	$V_{CE}=6\text{V}$, $I_C=20\text{mA}$, $f=30\text{MHz}$

CLASSIFICATION OF h_{FE}

Rank	L	H	J
Range	120-200	200-350	300-400
Marking	J3Y		

BIPOLAR TRANSISTOR (NPN)

Typical Characteristics

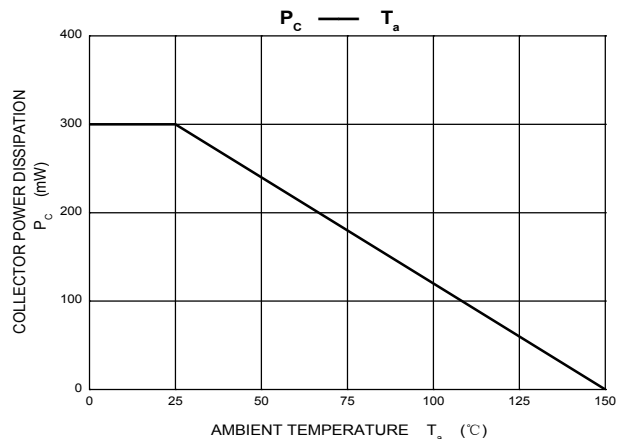
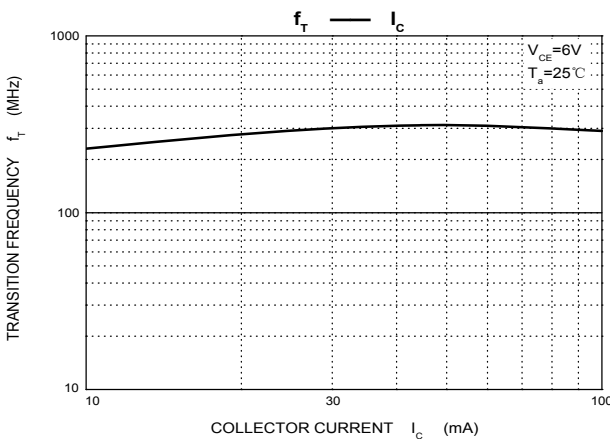
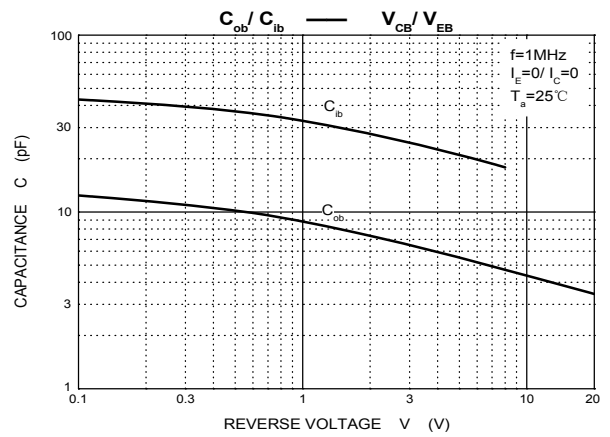
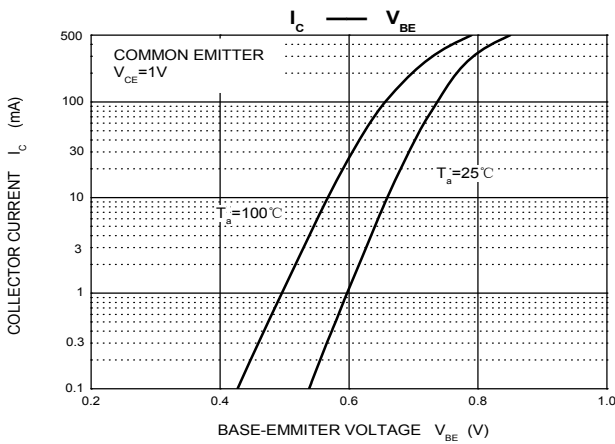
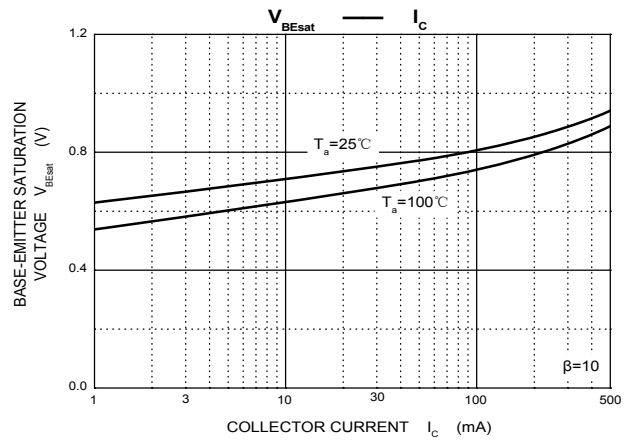
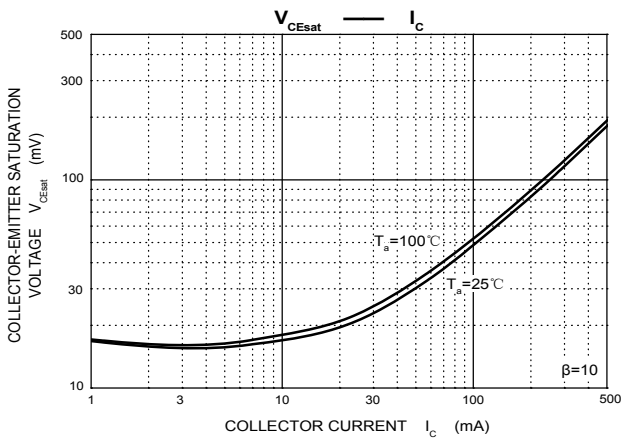
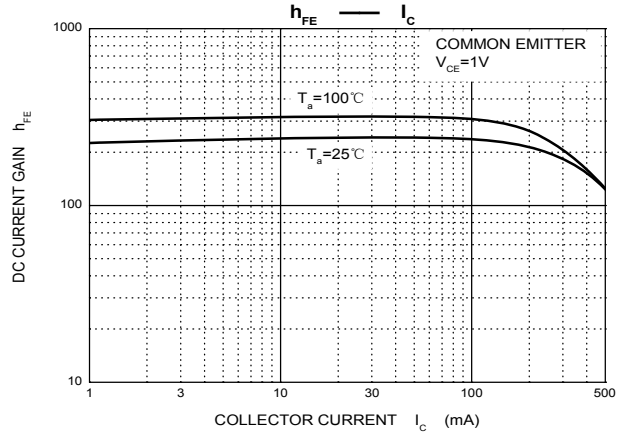
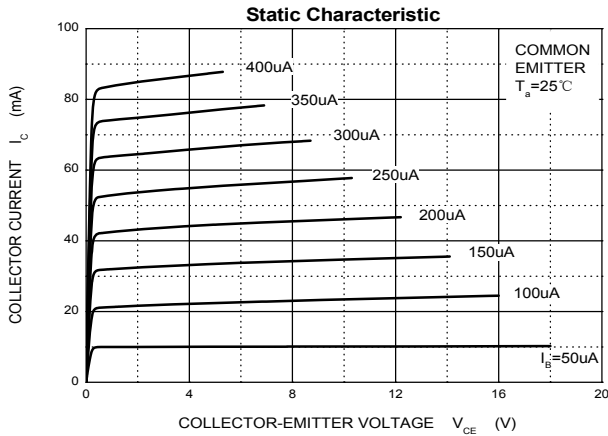

BIPOLAR TRANSISTOR (NPN)

SOT-23 Package Outline Dimensions



Symbol	Dimensions In Millimeters		Dimensions In Inches	
	Min.	Max.	Min.	Max.
A	0.900	1.150	0.035	0.045
A1	0.000	0.100	0.000	0.004
A2	0.900	1.050	0.035	0.041
b	0.300	0.500	0.012	0.020
c	0.080	0.150	0.003	0.006
D	2.800	3.000	0.110	0.118
E	1.200	1.400	0.047	0.055
E1	2.250	2.550	0.089	0.100
e	0.950 TYP		0.037 TYP	
e1	1.800	2.000	0.071	0.079
L	0.550 REF		0.022 REF	
L1	0.300	0.500	0.012	0.020
θ	0°	8°	0°	8°

SOT-23 Suggested Pad Layout

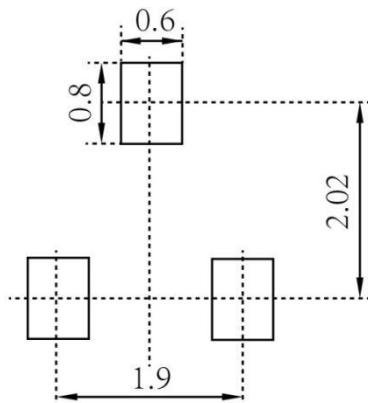

Note:

1. Controlling dimension: in millimeters
2. General tolerance: ±0.05mm
3. The pad layout is for reference purposes only

BIPOLAR TRANSISTOR (NPN)

SOT-23 Tape and Reel

SOT-23 Embossed Carrier Tape

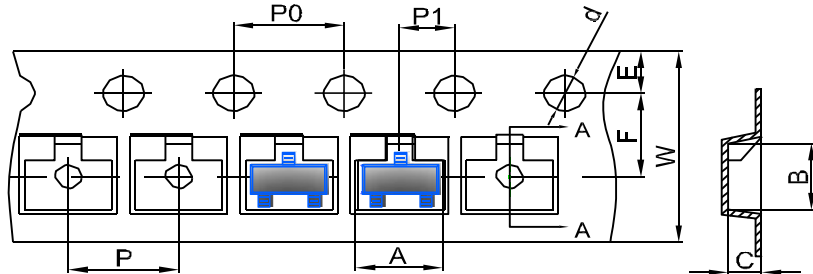

DIMENSIONS ARE IN MILLIMETER										
TYPE	A	B	C	d	E	F	P0	P	P1	W
SOT-23	3.15	2.77	1.22	Ø1.50	1.75	3.50	4.00	4.00	2.00	8.00
TOLERANCE	±0.1	±0.1	±0.1	±0.1	±0.1	±0.1	±0.1	±0.1	±0.1	±0.1

SOT-23 Tape Leader and Trailer

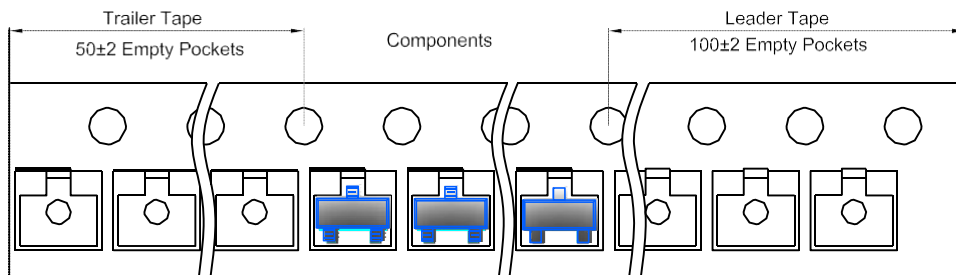

SOT-23 Reel

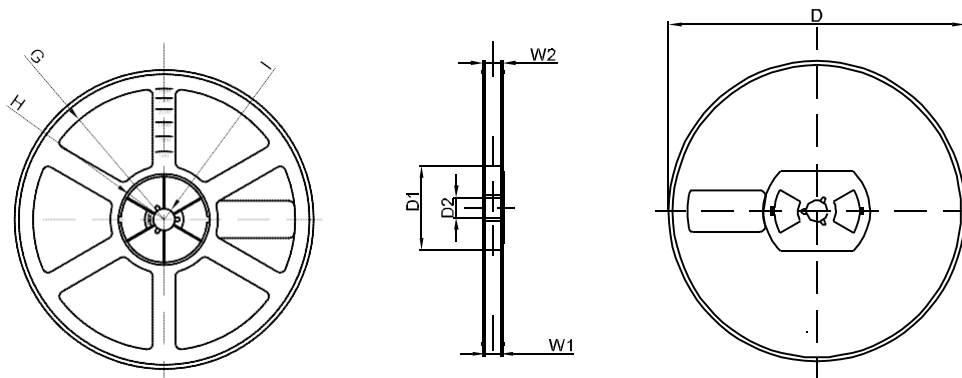

DIMENSIONS ARE IN MILLIMETER								
REEL OPTION	D	D1	D2	G	H	I	W1	W2
7" DIA	Ø178	54.40	13.00	R78	R25.60	R6.50	9.50	12.30
TOLERANCE	±2	±1	±1	±1	±1	±1	±1	±1