

GENERAL PURPOSE SOLID STATE RELAY 6PIN DIP TYPE FORM A SSR

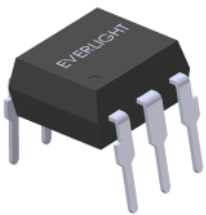

Schematic

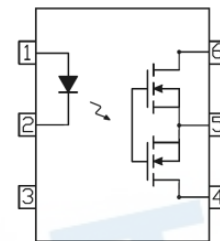

Pin Configuration

- 1, LED Anode
- 2, LED Cathode
- 4, 6 MOSFET Drain
- 5, MOSFET Source

Features

- Normally open signal pole signal throw relay
- Low operating current
- 60 to 600V output withstand voltage
- Low on resistance
- Wide operating temperature range of -40°C to 85°C
- High isolation voltage between input and output (Viso=5000 Vrms)
- UL 1577 + cUL approved (No. E214129)
- UL 508 + cUL approved (No. E348721)
- VDE approved (No. 40028391)
- SEMKO approved
- NEMKO approved
- DEMKO approved
- FIMKO approved
- CQC approved

Description

The EL606A, EL625A, EL640A and EL660A are solid state relays containing an AlGaAs infrared LEDs on the light emitting side (input side) optically coupled to a high voltage output detector circuit. The detector consists of a photovoltaic diode array and MOSFETs on the output side. They can enable AC/DC and DC only output connections. The single channel configuration is equivalent to 1 form A EMR. They are packaged in 6 pin DIP and available in surface mount SMD option.

Applications

- Exchange equipment
- Measurement equipment
- FA/OA equipment
- Industrial controls
- Security

Absolute Maximum Ratings (T_A=25°C, unless otherwise specified)

Parameter	Symbol	Type of connection	Rating				Unit	
			EL606A	EL625A	EL640A	EL660A		
Input	Forward Current	I _F		50			mA	
	Reverse Voltage	V _R		5			V	
	Peak Forward Current* ¹	I _{FP}		1			A	
	Power Dissipation	P _{in}		75			mW	
Output	Break Down Voltage	V _L		60	250	400	600	V
			A	550	150	120	50	mA
			B	650	220	130	60	mA
	Current	I _L	C	800	300	150	80	mA
			Pulse Load Current* ²	I _{LPeak}	1.2	0.5	0.3	0.15
	Power Dissipation	P _{out}			500			mW
Total Power Dissipation	P _T			550			mW	
Isolation Voltage* ³	V _{iso}			5000			V _{rms}	
Storage Temperature	T _{STG}			-40 to 125			°C	
Operating Temperature	T _{OPR}			-40 to 85			°C	
Soldering Temperature* ⁴	T _{SOL}			260			°C	

Notes:

*1. f =100Hz, Duty Cycle = 0.1%

*2. A connection: 100ms (1 shot), V_L = DC

*3. AC for 1 minute, R.H.= 40 ~ 60% R.H. In this test, pins 1, 2, 3 are shorted together, and pins 4, 5, 6 are shorted together.

*4. For 10 seconds

Electro-Optical Characteristics (T_A=25°C)

	Parameter	Symbol	Condition	Min.	Typ.	Max.	Unit	
Input	Forward Voltage	V _F	I _F = 10mA	-	1.18	1.5	V	
	Reverse Current	I _R	V _R = 5V	-	-	1	μA	
Output	Off State leakage Current	I _{leak}	I _F = 0mA, V _L = Max.	-	-	1	μA	
	On Resistance*	EL606A	R _{d(ON) A}	I _F = 5mA, I _L = Max. t = 1s	-	0.75	2.5	Ω
		EL625A			-	6.5	15	
		EL640A			-	20	30	
		EL660A			-	42	70	
	On Resistance*	EL606A	R _{d(ON) B}	I _F = 5mA, I _L = Max. t = 1s	-	0.4	1	Ω
		EL625A			-	3.4	5	
		EL640A			-	15.2	20	
		EL660A			-	28	50	
	On Resistance*	EL606A	R _{d(ON) C}	I _F = 5mA, I _L = Max. t = 1s	-	0.2	0.5	Ω
		EL625A			-	1.7	3	
		EL640A			-	7.6	15	
		EL660A			-	14	30	
	Output Capacitance	EL606A	C _{out}	V _L = 0V, f = 1MHz	-	85	-	pF
		EL625A			-	60	-	
EL640A		-			45	-		
EL660A		-			30	-		
Transfer Characteristics	LED turn on Current	EL606A	I _{F(on)}	I _L = Max.	-	1.38	3	mA
		EL625A			-	1.28	3	
		EL640A			-	1.36	3	
		EL660A			-	1.32	3	
	LED turn off current	EL606A	I _{F(off)}	I _L = Max.	0.4	1.22	-	mA
		EL625A			0.4	1.12	-	
		EL640A			0.4	1.38	-	
		EL660A			0.4	1.2	-	
	Turn On Time	EL606A	T _{on}	I _F = 10 mA, I _L = Max. R _L = 200Ω	-	1.3	3	ms
		EL625A			-	1	3	
		EL640A			-	0.35	3	
		EL660A			-	1	3	
Turn Off Time	EL606A	T _{off}	I _F = 10 mA, I _L = Max. R _L = 200Ω	-	0.1	0.5	ms	
	EL625A			-	0.1	0.5		
	EL640A			-	0.1	0.5		
	EL660A			-	0.1	0.5		
Isolation Resistance		R _{I-O}	V _{I-O} = 500V DC	5×10 ¹⁰	-	-	Ω	

Isolation Capacitance	C_{i-o}	$V = 0V, f = 1MHz$	-	1.5	-	pF
Turn on/Turn off Time						

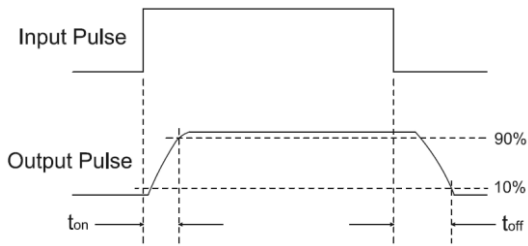

Note:

* On resistance test

Connection A

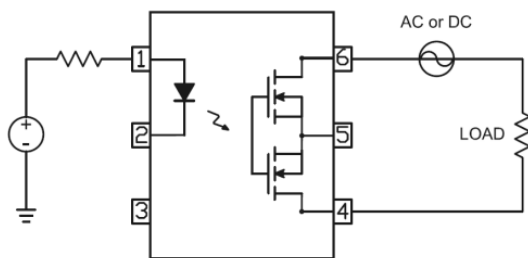

Connection B

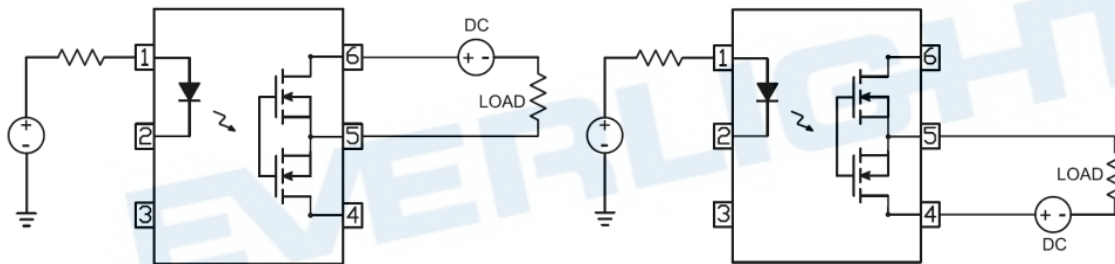

Connection C

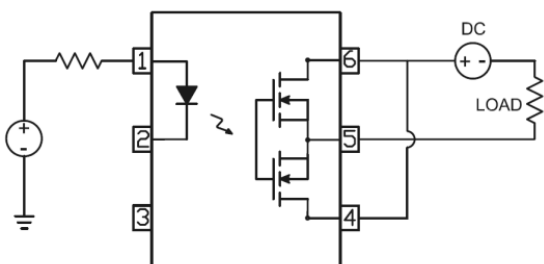

Typical Electro-Optical Characteristics Curves

Figure 1-1. Load current vs Ambient temperature

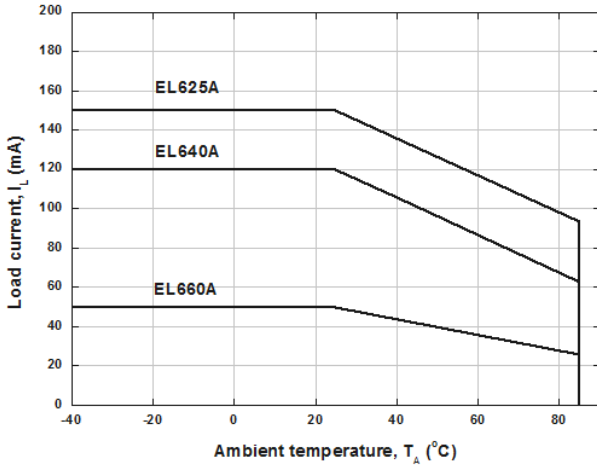

Figure 1-2. Load current vs Ambient temperature

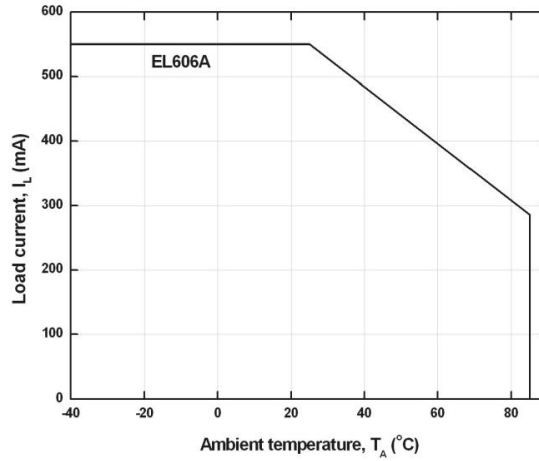

Figure 2-1. On Resistance vs Ambient Temperature

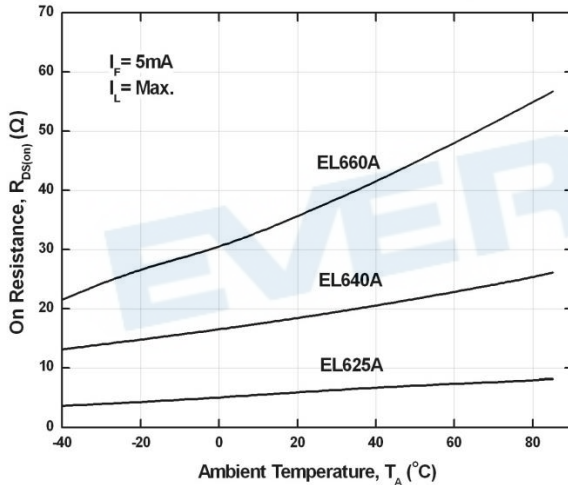

Figure 2-2. On Resistance vs Ambient Temperature

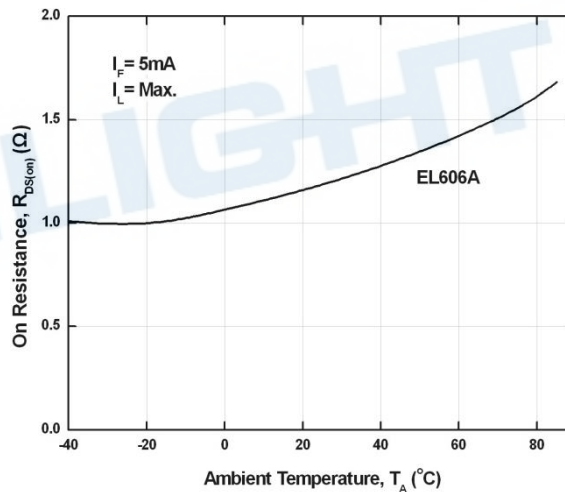

Figure 3. Switching Time vs Ambient Temperature

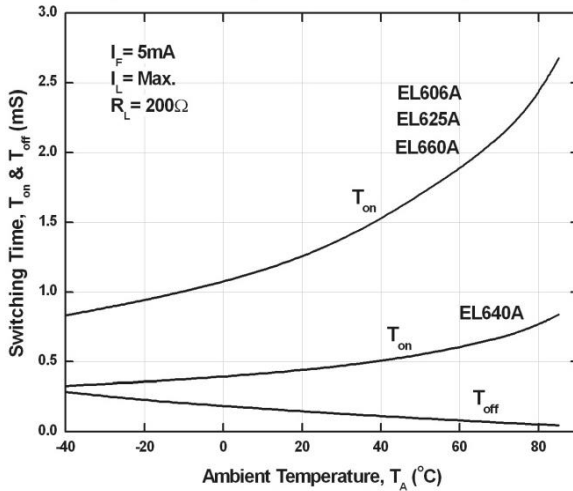

Figure 4. Turn On Time vs LED Forward Current

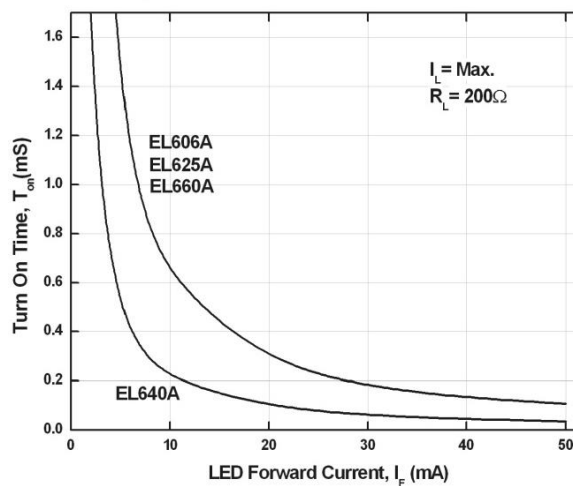

Figure 5. Turn Off Time vs LED Forward Current

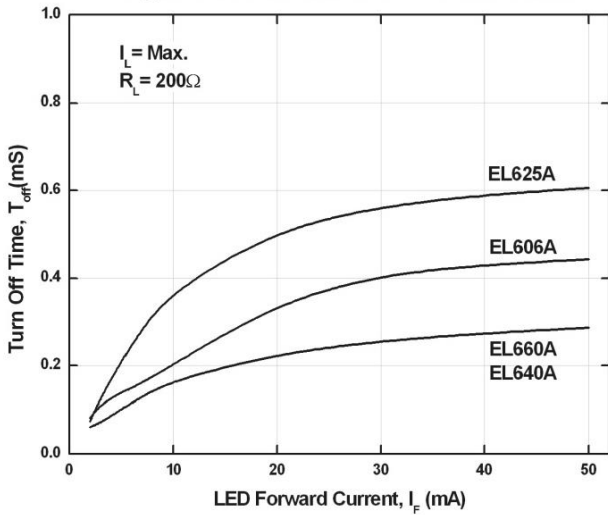

Figure 6. LED Operate on Current vs Ambient Temperature

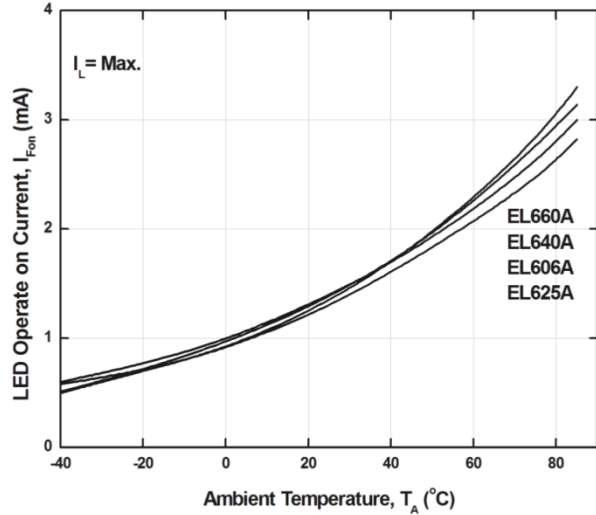

Figure 7. LED Turn off Current vs Ambient Temperature

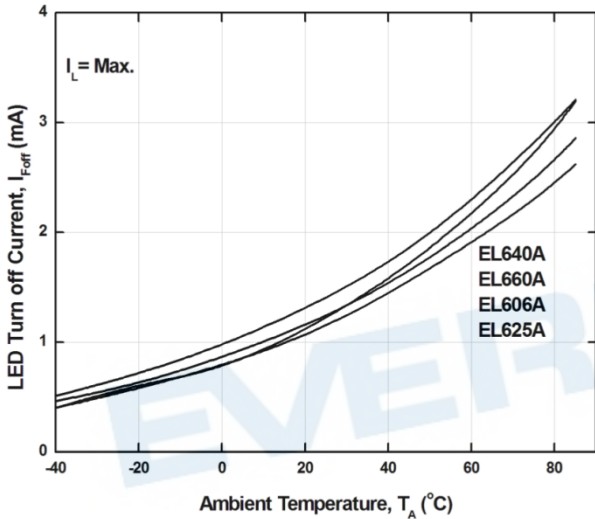

Figure 8. LED Dropout Voltage vs Ambient Temperature

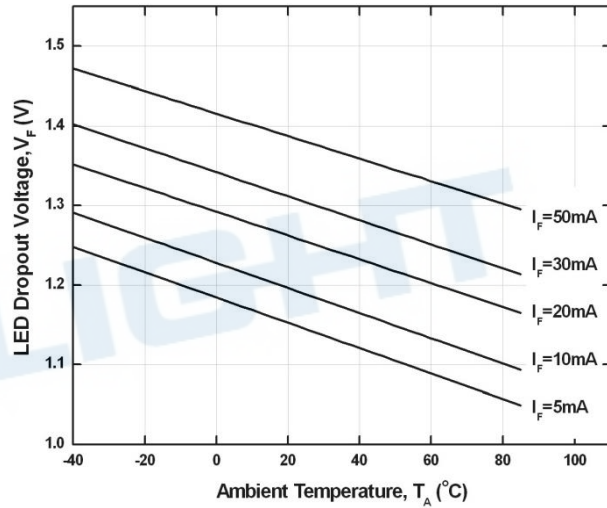

Figure 9-1. Load Voltage vs Load Current

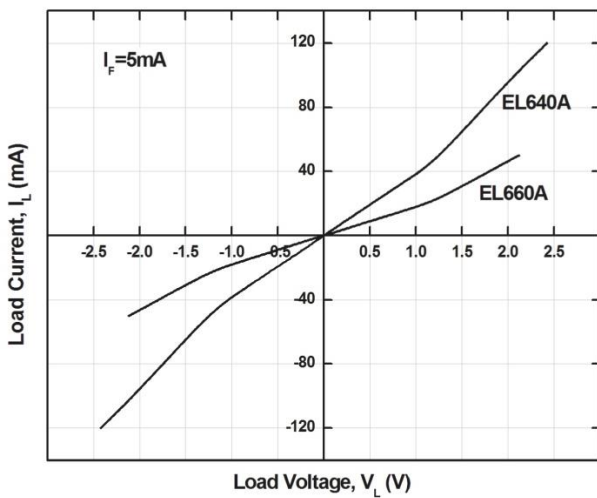

Figure 9-2. Load Voltage vs Load Current

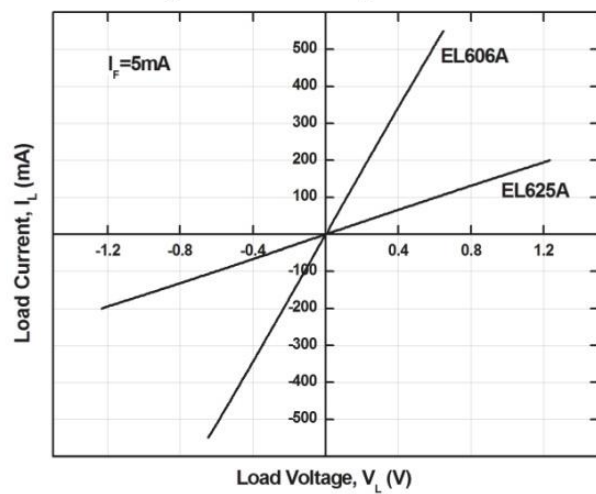

Figure 10. Off State Leakage Current vs Load Voltage

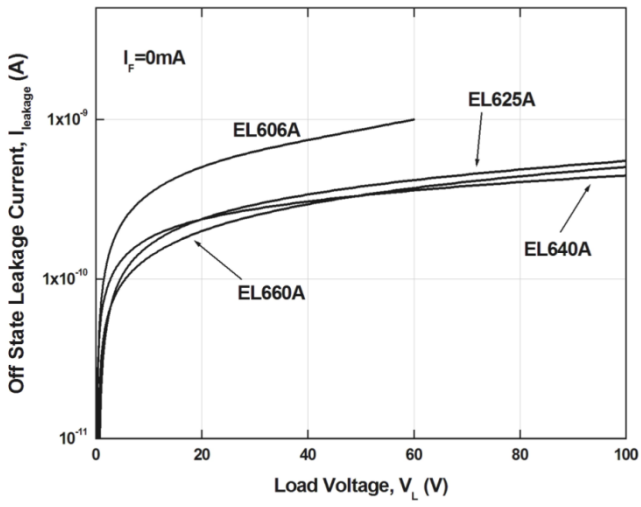
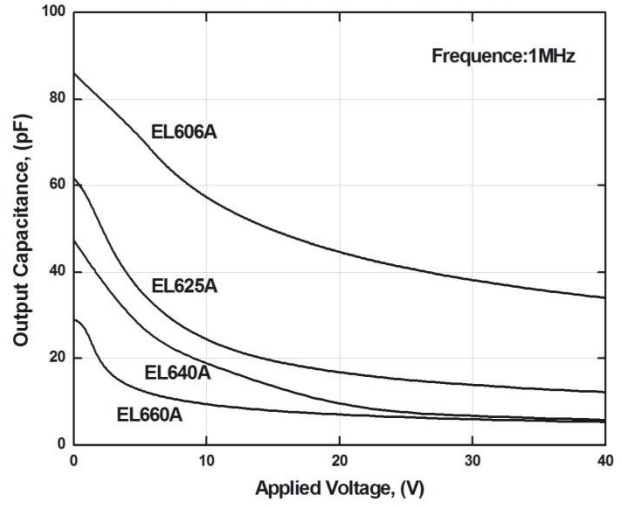

Figure 11. Applied Voltage VS Output Capacitance



EVERLIGHT

Order Information

Part Number

EL6XXA(Y)(Z)-V

Note:

XX = Part No. (06, 25, 40 or 60)

Y = Lead form option (S1, or none)

Z = Tape and reel option (TA, TB, TU, TD or none).

V = VDE safety approved option

Option	Description	Packing quantity
None	Standard DIP-6	65 units per tube
S1 (TA)	Surface mount lead form (low profile) + TA tape & reel option	1000 units per reel
S1 (TB)	Surface mount lead form (low profile) + TB tape & reel option	1000 units per reel

EVERLIGHT

Package Dimension

Standard DIP Type

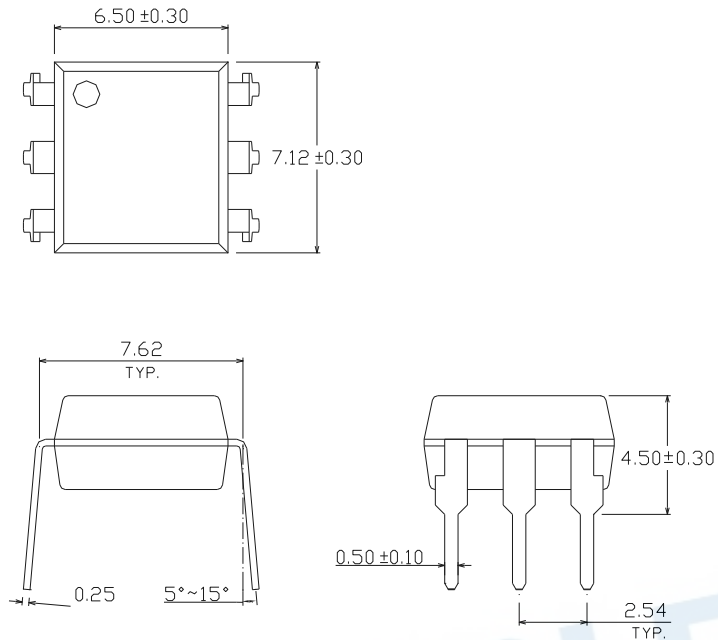

Option S1 Type

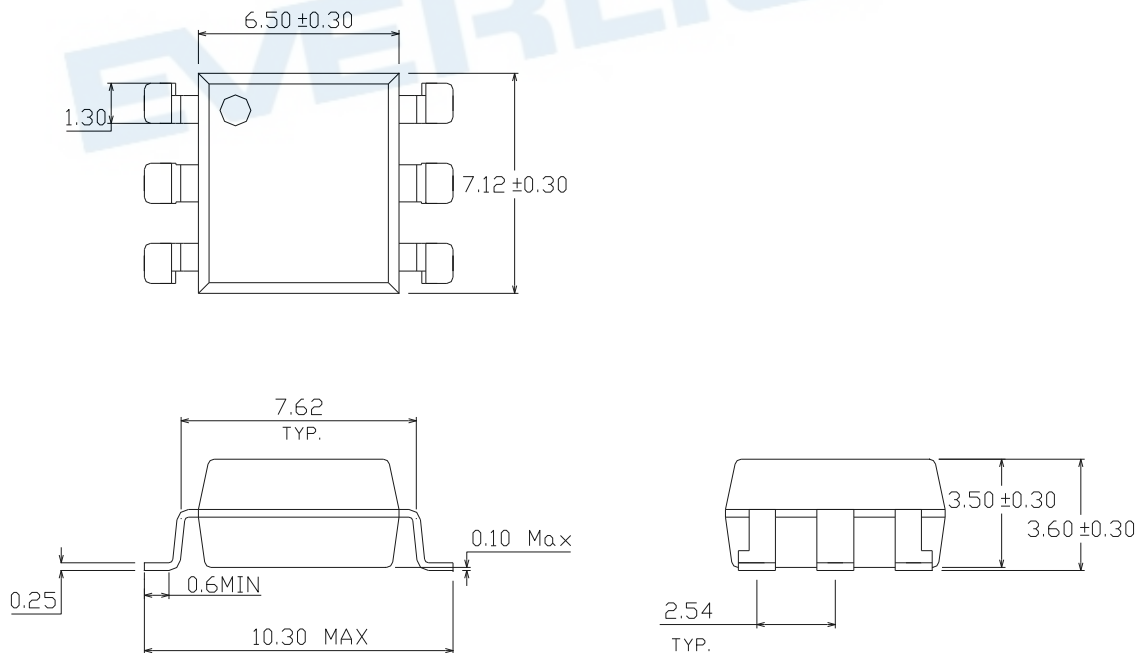

Recommended pad layout for surface mount leadform

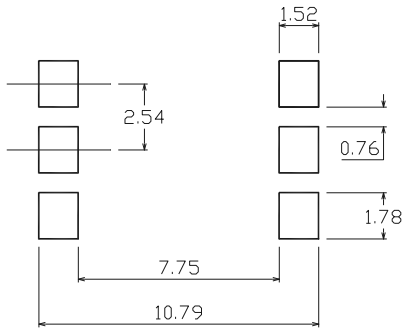

Device Marking

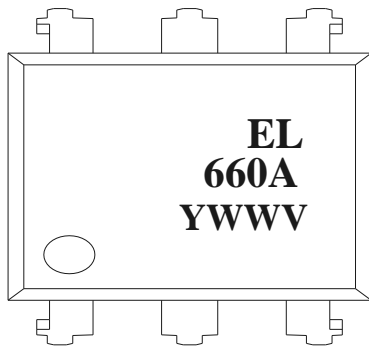

Notes

- EL denotes Everlight
- 660A denotes Part Number
- Y denotes 1 digit Year code
- WW denotes 2 digit Week code
- V denotes VDE option

Tape & Reel Packing Specifications

Option TA

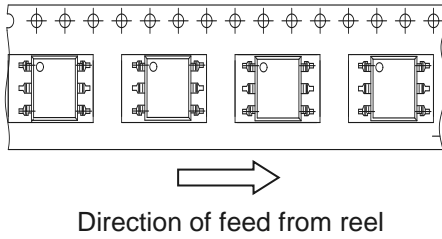

Option TB

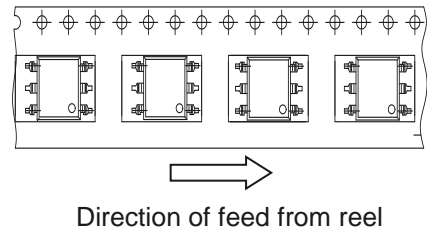

Tape Dimensions

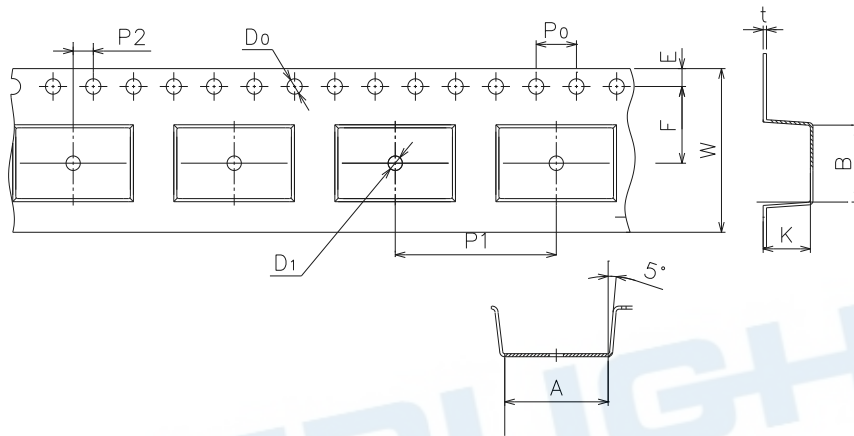

Dimension No.	A	B	D ₀	D ₁	E	F
Dimension (mm)	10.8±0.1	7.5±0.1	1.5±0.1	1.5±0.1	1.75±0.1	7.5±0.1

Dimension No.	P ₀	P ₁	P ₂	t	W	K
Dimension (mm)	4.0±0.15	12±0.1	2.0±0.1	0.35±0.03	16.0±0.2	4.5±0.1

Precautions for Use

1. Soldering Condition

1.1 (A) Maximum Body Case Temperature Profile for evaluation of Reflow Profile

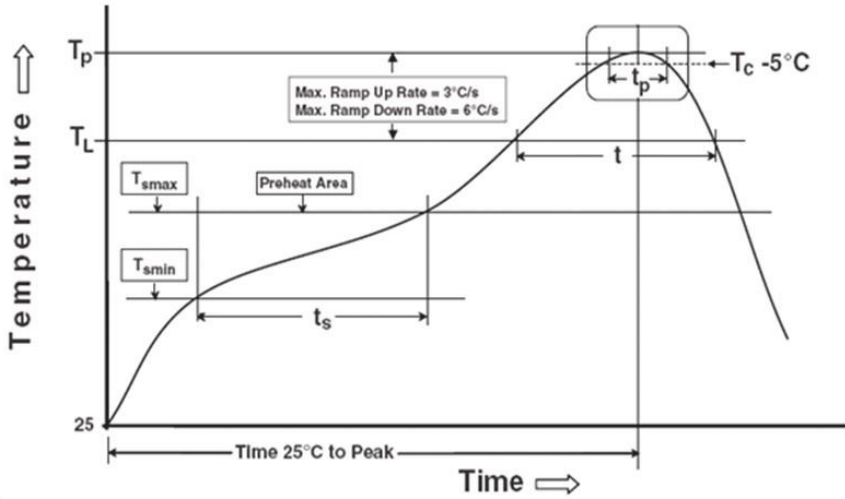

Note:

Reference: IPC/JEDEC J-STD-020D

Preheat

Temperature min (T_{smin})	150 °C
Temperature max (T_{smax})	200°C
Time (T_{smin} to T_{smax}) (t_s)	60-120 seconds
Average ramp-up rate (T_{smax} to T_p)	3 °C/second max

Other

Liquidus Temperature (T_L)	217 °C
Time above Liquidus Temperature (t_L)	60-100 sec
Peak Temperature (T_p)	260°C
Time within 5 °C of Actual Peak Temperature: $T_p - 5^\circ\text{C}$	30 s
Ramp- Down Rate from Peak Temperature	6°C /second max.
Time 25°C to peak temperature	8 minutes max.
Reflow times	3 times

DISCLAIMER

1. Above specification may be changed without notice. EVERLIGHT will reserve authority on material change for above specification.
2. The graphs shown in this datasheet are representing typical data only and do not show guaranteed values.
3. When using this product, please observe the absolute maximum ratings and the instructions for use outlined in these specification sheets. EVERLIGHT assumes no responsibility for any damage resulting from use of the product which does not comply with the absolute maximum ratings and the instructions included in these specification sheets.
4. These specification sheets include materials protected under copyright of EVERLIGHT. Reproduction in any form is prohibited without the specific consent of EVERLIGHT.
5. This product is not intended to be used for military, aircraft, automotive, medical, life sustaining or life saving applications or any other application which can result in human injury or death. Please contact authorized Everlight sales agent for special application request.
6. Statements regarding the suitability of products for certain types of applications are based on Everlight's knowledge of typical requirements that are often placed on Everlight products in generic applications. Such statements are not binding statements about the suitability of products for a particular application. It is the customer's responsibility to validate that a particular product with the properties described in the product specification is suitable for use in a particular application. Parameters provided in datasheets and/or specifications may vary in different applications and performance may vary over time. All operating parameters, including typical parameters, must be validated for each customer application by the customer's technical experts. Product specifications do not expand or otherwise modify Everlight's terms and conditions of purchase, including but not limited to the warranty expressed therein.