

Small Signal MOSFET

115 mAmps, 60 Volts

N-Channel SOT-723

- Pb-Free Package is Available.
- ESD Protected:2000V
- S- Prefix for Automotive and Other Applications Requiring Unique Site and Control Change Requirements; AEC-Q101 Qualified and PPAP Capable.

ORDERING INFORMATION

Device	Marking	Shipping
L2N7002EM3T5G S-L2N7002EM3T5G	RK	8000 Tape & Reel

MAXIMUM RATINGS

Rating	Symbol	Value	Unit
Drain-Source Voltage	V_{DSS}	60	V _{dc}
Drain Current - Continuous $T_C = 25^\circ\text{C}$ (Note 1.) - Pulse $t < 10\mu\text{s}$	I_D I_{DM}	± 115 ± 800	mAdc
Gate-Source Voltage - Continuous	V_{GS}	± 20	V _{dc}

THERMAL CHARACTERISTICS

Characteristic	Symbol	Max	Unit
Total Device Dissipation FR-5 Board (Note 2.) $T_A = 25^\circ\text{C}$ Derate above 25°C	P_D	150 1.2	mW mW/ $^\circ\text{C}$
Thermal Resistance, Junction to Ambient	$R_{\theta JA}$	833	$^\circ\text{C}/\text{W}$
Junction and Storage Temperature	T_J, T_{stg}	-55 to +150	$^\circ\text{C}$

1. The Power Dissipation of the package may result in a lower continuous drain current.
2. FR-5 = 1.0 x 0.75 x 0.062 in.
3. Alumina = 0.4 x 0.3 x 0.025 in 99.5% alumina.

L2N7002EM3T5G
S-L2N7002EM3T5G

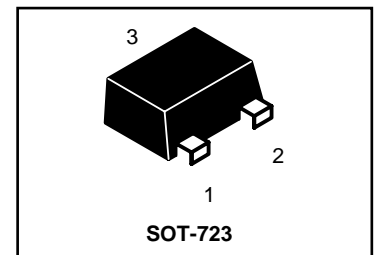

N - Channel

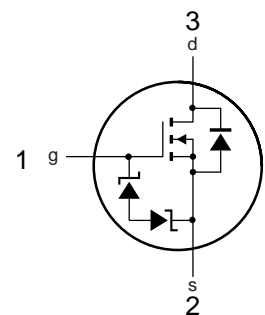

MARKING DIAGRAM & PIN ASSIGNMENT

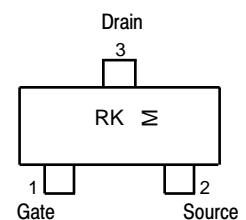

RK = Device Code
M = Month Code

L2N7002EM3T5G , S-L2N7002EM3T5G

● **Electrical characteristics (Ta=25°C)**

Parameter	Symbol	Min.	Typ.	Max.	Unit	Test Conditions
Gate-source leakage current	I_{GSS}	-	-	± 10	μA	$V_{GS}=\pm 20V, V_{DS}=0V$
Drain-source breakdown voltage	$V_{(BR)DSS}$	60	-	-	V	$I_D=10\mu A, V_{GS}=0V$
Zero gate voltage drain current	I_{DSS}	-	-	1	μA	$V_{DS}=60V, V_{GS}=0V$
Gate threshold voltage	$V_{GS(th)}$	1	1.85	2.5	V	$V_{DS}=V_{GS}, I_D=250\mu A$
Drain-source on-state resistance	$R_{DS(on)*}$	-	-	7.5	Ω	$I_D=0.5A, V_{GS}=10V$
		-	-	7.5		$I_D=0.05A, V_{GS}=5V$
Forward transfer admittance	$ Y_{fs} *$	80	-	-	mS	$V_{DS}=10V, I_D=0.2A$
Input capacitance	C_{iss}	-	25	50	pF	$V_{DS}=25V$
Output capacitance	C_{oss}	-	10	25	pF	$V_{GS}=0V$
Reverse transfer capacitance	C_{rss}	-	3.0	5.0	pF	$f=1MHz$
Turn-on delay time	$t_{d(on)*}$	-	12	20	ns	$I_D=200mA, V_{DD}=30V$
Turn-off delay time	$t_{d(off)*}$	-	20	30	ns	$V_{GS}=10V, R_L=150\Omega, R_{GS}=10\Omega$

* $P_w \leq 300\mu s$, Duty cycle $\leq 1\%$

● **Electrical characteristic curves**

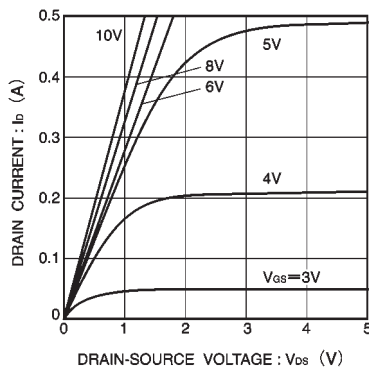

Fig.1 Typical output characteristics

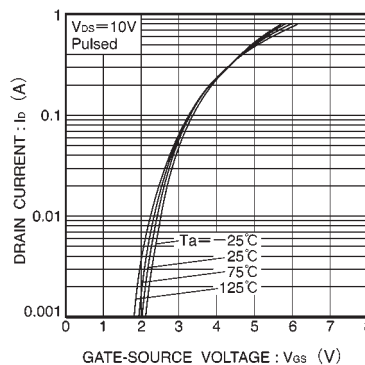

Fig.2 Typical transfer characteristics

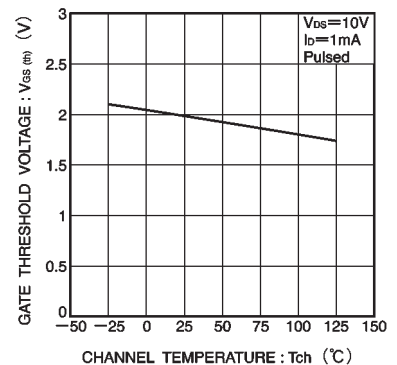

Fig.3 Gate threshold voltage vs. channel temperature

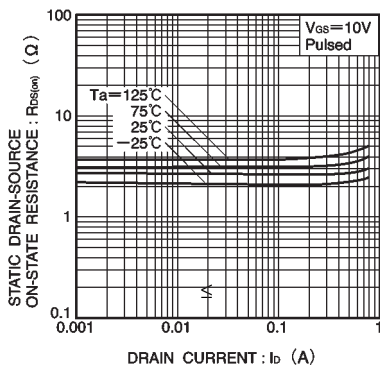

Fig.4 Static drain-source on-state resistance vs. drain current (I)

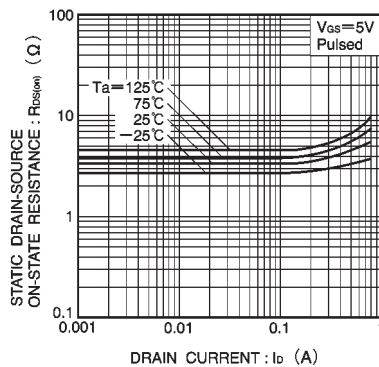

Fig.5 Static drain-source on-state resistance vs. drain current (II)

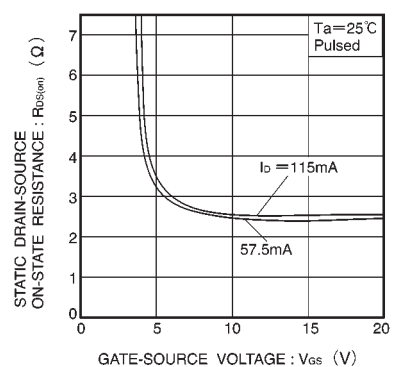

Fig.6 Static drain-source on-state resistance vs. gate-source voltage

L2N7002EM3T5G , S-L2N7002EM3T5G

●Electrical characteristic curves (continues)

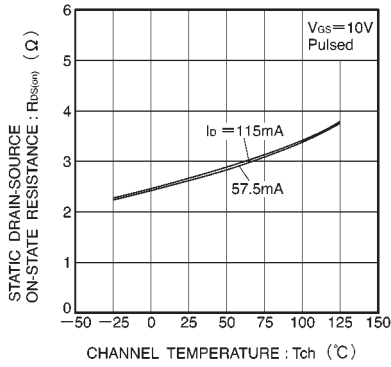

Fig.7 Static drain-source on-state resistance vs. channel temperature

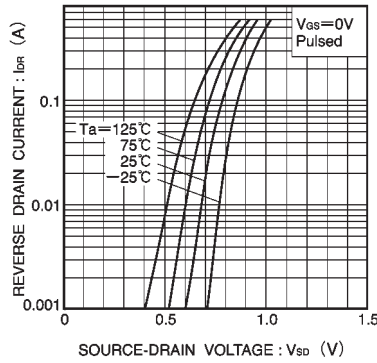

Fig.8 Reverse drain current vs. source-drain voltage (I)

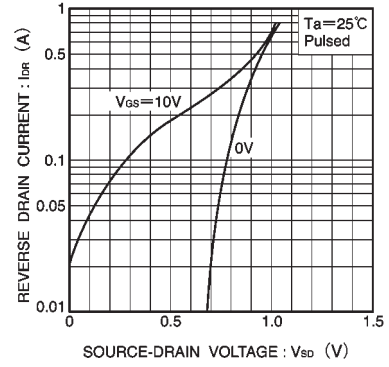

Fig.9 Reverse drain current vs. source-drain voltage (II)

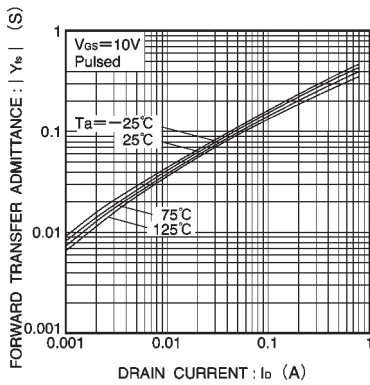

Fig.10 Forward transfer admittance vs. drain current

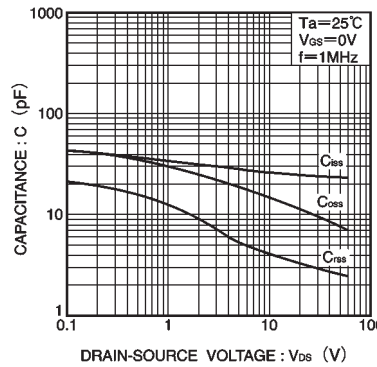

Fig.11 Typical capacitance vs. drain-source voltage

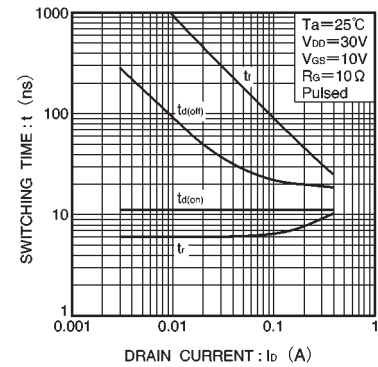

Fig.12 Switching characteristics
(See Figures 13 and 14 for the measurement circuit and resultant waveforms)

●Switching characteristics measurement circuit

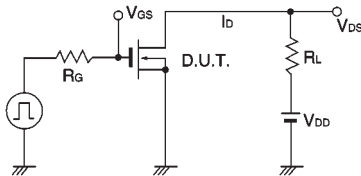

Fig.13 Switching time measurement circuit

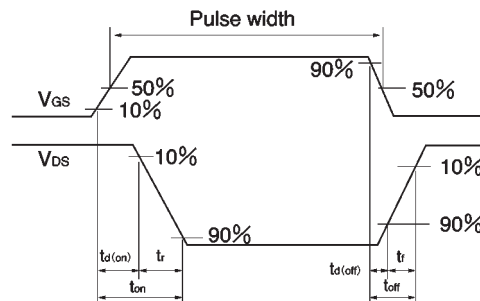
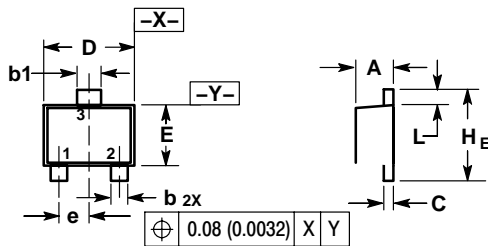

Fig.14 Switching time waveforms

SOT-723



NOTES:

1. DIMENSIONING AND TOLERANCING PER ANSI Y14.5M, 1982.
2. CONTROLLING DIMENSION: MILLIMETERS.
3. MAXIMUM LEAD THICKNESS INCLUDES LEAD FINISH. MINIMUM LEAD THICKNESS IS THE MINIMUM THICKNESS OF BASE MATERIAL.
4. DIMENSIONS D AND E DO NOT INCLUDE MOLD FLASH, PROTRUSIONS OR GATE BURRS.

DIM	MILLIMETERS			INCHES		
	MIN	NOM	MAX	MIN	NOM	MAX
A	0.45	0.50	0.55	0.018	0.020	0.022
b	0.15	0.20	0.27	0.0059	0.0079	0.0106
b1	0.25	0.3	0.35	0.010	0.012	0.014
C	0.07	0.12	0.17	0.0028	0.0047	0.0067
D	1.15	1.20	1.25	0.045	0.047	0.049
E	0.75	0.80	0.85	0.03	0.032	0.034
e	0.40 BSC			0.016 BSC		
HE	1.15	1.20	1.25	0.045	0.047	0.049
L	0.15	0.20	0.25	0.0059	0.0079	0.0098

SOLDERING FOOTPRINT

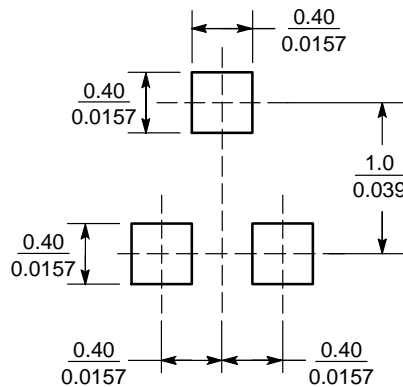

($\frac{\text{mm}}{\text{inches}}$)