

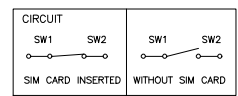

REV.	ECN NO OR DESCRIPTION	REVISED	DATE

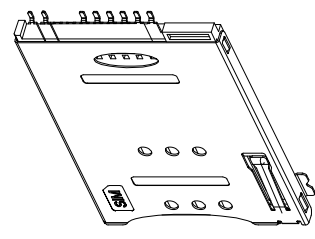

pin no.	name
C1	vcc of sim
C2	rst of sim
C3	clk of sim
C5	gnd of sim
C6	vpp of sim
C7	I/O of sim
C4/C8	n/a
SW1	switch1
SW2	switch2

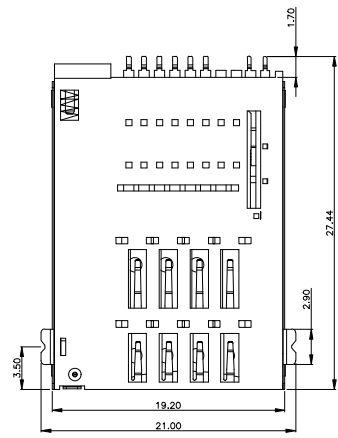
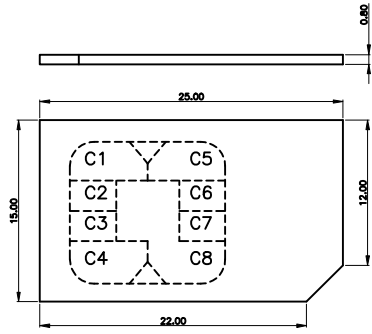
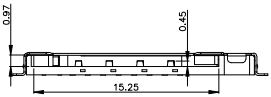
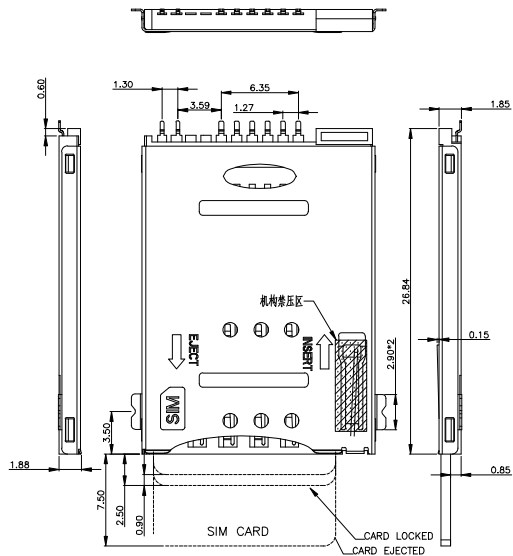
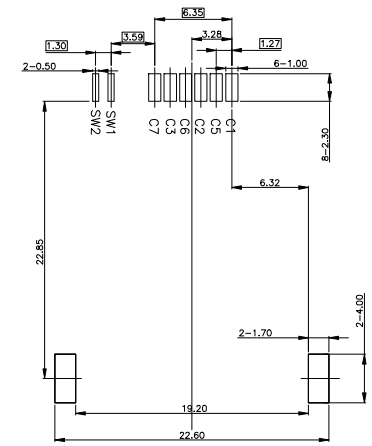

RECOMMENDED PCB LAYOUT  
GENERAL TOLERANCE ±0.05

**SPECIFICATION**  
**MATERIAL:**  
 INSULATOR: HIGH TEMPERATURE THERMOPLASTIC,  
 UL 94V-0.COLOR: BLACK LCP  
 CONTACT: COPPER ALLOY  
**PLATING:**  
 CONTACT: PLATED 30U" NI OVERALL  
 PLATED AU SELECTIVE CONTACT AREA  
 SHELL: PLATED 30U" NI OVERALL,PAD G/F AU  
**ELECTRICAL:**  
 CURRENT RATING: 0.5AMPS  
 VOLTAGE RATING: 5V AC/DC  
 AMBIENT TEMPERATURE RANGE: -20°C~+60°C  
 STORAGE TEMPERATURE RANGE: -40°C~+80°C  
 AMBIENT HUMIDITY RANGE: 95% R.H. MAX.  
 CONTACT RESISTANCE: 100MΩMAX.  
 INSULATION RESISTANCE: 1000MΩMIN./500VDC  
 MATING CYCLES: 5,000 INSERTIONS  
 REFLOW PEAK TEMP: 260°C

UNLESS OTHERWISE SPECIFIED TOLERANCES		东莞市汉博电子科技有限公司 DONGGUAN HANBO TECHNOLOGY CO., LTD			
DECIMALS:	ANGLES:	TITLE	Mini Sim Card Push Push 6+2P Smt无铅		
X :±0.5	X :±2°	DWN	xiong	SIM-204	
X.X :±0.20	X.X :±1°	CHKD	lee	SCALE:1:1	UNIT: mm
X.XX :±0.10		APVD	wang	SIZE: A4	SHEET:10F 1
		REV: A4			
CUSTOMER COPY					