

N-Channel Enhancement Mode Power MOSFET

Features

- $V_{DS} = 20V$, $I_D = 10 A$
 $R_{DS(ON)} < 11 m\Omega @ V_{GS} = 4.5V$
 $R_{DS(ON)} < 14 m\Omega @ V_{GS} = 2.5V$

General Features

- Advanced Trench Technology
- Provide Excellent $R_{DS(ON)}$ and Low Gate Charge
- Lead Free and Green Available

100% UIS TESTED!
 100% ΔV_{ds} TESTED!



SOP-8

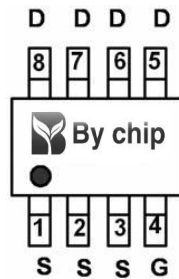

pin assignment



Schematic diagram

■ Absolute Maximum Ratings ($T_A = 25^\circ C$ unless otherwise noted)

| Parameter | | Symbol | Limit | Unit |
|---|--------------------|-----------------|------------|--------------|
| Drain-source Voltage | | V_{DS} | 20 | V |
| Gate-source Voltage | | V_{GS} | ± 10 | V |
| Drain Current | $T_A = 25^\circ C$ | I_D | 10 | A |
| | $T_A = 70^\circ C$ | | 8 | |
| Pulsed Drain Current ^A | | I_{DM} | 45 | A |
| Total Power Dissipation | $T_A = 25^\circ C$ | P_D | 1.9 | W |
| | $T_A = 70^\circ C$ | | 1.2 | |
| Thermal Resistance Junction-to-Ambient ^B | | $R_{\theta JA}$ | 66 | $^\circ C/W$ |
| Junction and Storage Temperature Range | | T_J, T_{STG} | -55 ~ +150 | $^\circ C$ |

■ Electrical Characteristics ($T_J=25^{\circ}\text{C}$ unless otherwise noted)

| Parameter | Symbol | Conditions | Min | Typ | Max | Units |
|-----------------------------------|--------------|--|-----|-------|-----------|------------|
| Static Parameter | | | | | | |
| Drain-Source Breakdown Voltage | BV_{DSS} | $V_{GS}=0V, I_D=250\mu A$ | 20 | | | V |
| Zero Gate Voltage Drain Current | I_{DSS} | $V_{DS}=20V, V_{GS}=0V$ | | | 1 | μA |
| Gate-Body Leakage Current | I_{GSS} | $V_{GS}=\pm 10V, V_{DS}=0V$ | | | ± 100 | nA |
| Gate Threshold Voltage | $V_{GS(th)}$ | $V_{DS}=V_{GS}, I_D=250\mu A$ | 0.5 | | 2.0 | V |
| Static Drain-Source On-Resistance | $R_{DS(on)}$ | $V_{GS}=4.5V, I_D=10A$ | | | 11 | m Ω |
| | | $V_{GS}=2.5V, I_D=4A$ | | | 14 | |
| | | $V_{GS}=1.8V, I_D=2A$ | | | 18.2 | |
| Diode Forward Voltage | V_{SD} | $I_S=10A, V_{GS}=0V$ | | | 1.2 | V |
| Dynamic Parameters | | | | | | |
| Input Capacitance | C_{iss} | $V_{DS}=10V, V_{GS}=0V, f=1\text{MHZ}$ | | 888 | | pF |
| Output Capacitance | C_{oss} | | | 133 | | |
| Reverse Transfer Capacitance | C_{rss} | | | 117 | | |
| Switching Parameters | | | | | | |
| Total Gate Charge | Q_g | $V_{GS}=4.5V, V_{DS}=10V, I_D=6.8A$ | | 11.05 | | nC |
| Gate-Source Charge | Q_{gs} | | | 1.73 | | |
| Gate-Drain Charge | Q_{gd} | | | 3.1 | | |
| Turn-on Delay Time | $t_{D(on)}$ | $V_{GS}=4.5V, V_{DS}=10V, I_D=6.8A$ $R_{GEN}=3\Omega$ | | 7 | | ns |
| Turn-on Rise Time | t_r | | | 46 | | |
| Turn-off Delay Time | $t_{D(off)}$ | | | 30 | | |
| Turn-off fall Time | t_f | | | 52 | | |

A. Pulse Test: Pulse Width $\leq 300\mu s$, Duty cycle $\leq 2\%$.

B. $R_{\theta JA}$ is the sum of the junction-to-case and case-to-ambient thermal resistance, where the case thermal reference is defined as the solder mounting surface of the drain pins. $R_{\theta JC}$ is guaranteed by design, while $R_{\theta JA}$ is determined by the board design. The maximum rating presented here is based on mounting on a 1 in 2 pad of 2oz copper.

■ Typical Performance Characteristics



Figure1. Output Characteristics



Figure2. Transfer Characteristics



Figure 3: On-Resistance vs. Drain Current and Gate Voltage

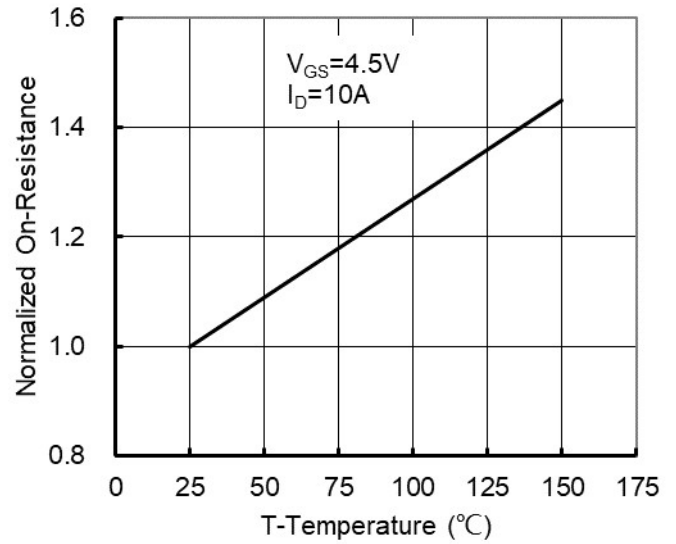

Figure 4: On-Resistance vs. Junction Temperature



Figure5. Capacitance Characteristics



Figure6. Gate Charge



Figure7. Safe Operation Area



Figure8. Maximum Continuous Drain Current vs Ambient Temperature



Figure9. Normalized Maximum Transient Thermal Impedance

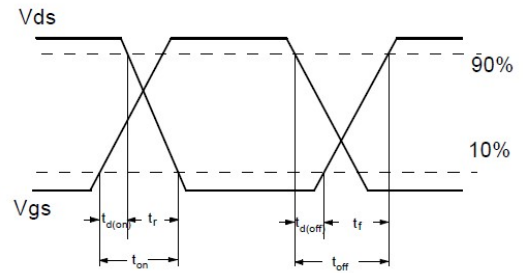

Resistive Switching Test Circuit & Waveforms



Diode Recovery Test Circuit & Waveforms

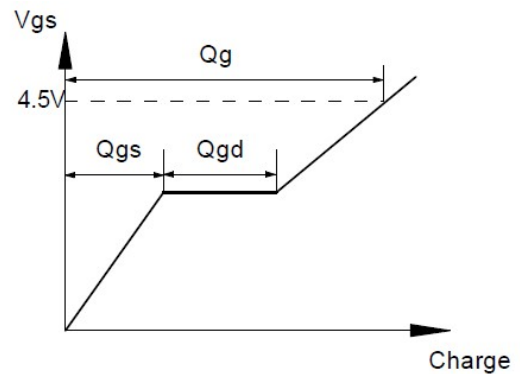
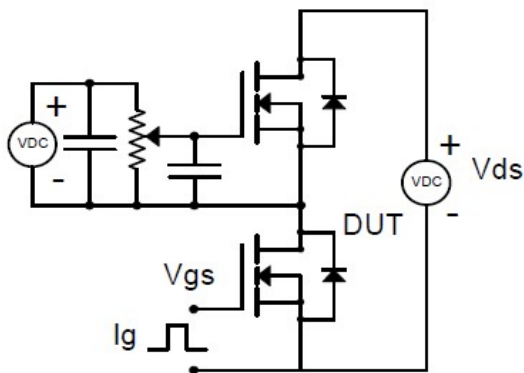

Gate Charge Test Circuit & Waveform

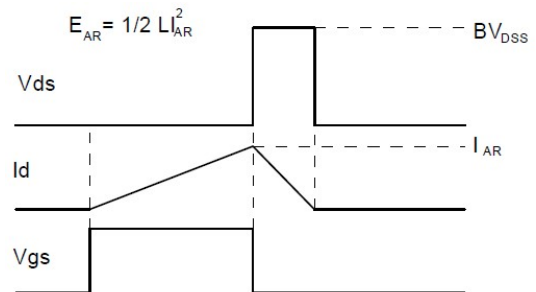
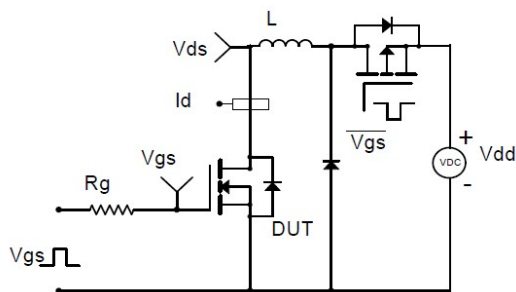

Unclamped Inductive Switching (UIS) Test Circuit & Waveforms