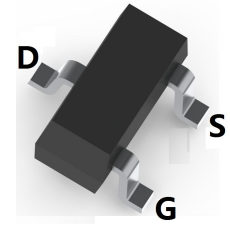
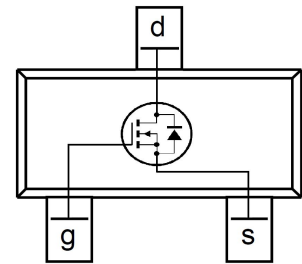

MOSFET (N-CHANNEL)
FEATURES

- $V_{DS}=20V$, $I_D=6.3A$, $R_{DS(ON)}<21m\Omega@V_{GS}=4.5V$
- Fast switching
- Ultra Low On-Resistance
- Surface Mount device

SOT-23

MECHANICAL DATA

- Case: SOT-23
- Case Material: Molded Plastic. UL flammability
- Classification Rating: 94V-0
- Weight: 0.008 grams (approximate)

MAXIMUM RATINGS ($T_A = 25^\circ C$ unless otherwise noted)

Parameter	Symbol	Value	Unit
Drain-source voltage	V_{DS}	20	V
Gate-source voltage	V_{GS}	± 12	V
Continuous drain current	I_D	$T_A=25^\circ C$	6.3
		$T_A=70^\circ C$	5.1
Pulsed drain current (Note 1)	I_{DM}	32	A
Power dissipation	P_D	$T_A=25^\circ C$	1.3
		$T_A=70^\circ C$	0.8
Linear Derating Factor		0.01	W/ $^\circ C$
Thermal resistance from Junction to ambient	$R_{\theta JA}^*$	100	$^\circ C/W$
Storage and Junction temperature	T_J, T_{STG}	-55 ~ +150	$^\circ C$

*Surface mounted on 1 in square Cu board

ELECTRICAL CHARACTERISTICS ($T_A = 25^\circ C$ unless otherwise specified)

Parameter	Symbol	Min	Typ	Max	Unit	Conditions
Drain-Source breakdown voltage	$V_{(BR)DSS}$	20			V	$V_{GS}=0V, I_D=250\mu A$
Zero gate voltage drain current	I_{DSS}			1	μA	$V_{DS}=16V, V_{GS}=0V$
				150		$V_{DS}=16V, V_{GS}=0V, T_J=125^\circ C$
Gate-body leakage current	I_{GSS}			± 100	nA	$V_{DS}=0V, V_{GS}=\pm 12V$
Gate-threshold voltage (note 1)	$V_{GS(th)}$	0.5	0.9	1.1	V	$V_{DS}=V_{GS}, I_D=10\mu A$
Drain-source on-resistance(note 1)	$R_{DS(ON)}$		16	21	$m\Omega$	$V_{GS}=4.5V, I_D=6.3A$
			22	27	$m\Omega$	$V_{GS}=2.5V, I_D=5.1A$
Internal Gate Resistance	R_G		1.7		Ω	
Forward transconductance(note 1)	g_{FS}	17			S	$V_{DS}=10V, I_D=6.3A$
Input capacitance	C_{iss}		700		pF	$V_{DS}=16V, V_{GS}=0V, f=1MHz$
Output capacitance	C_{oss}		140		pF	
Reverse transfer capacitance	C_{rss}		98		pF	
Turn-on delay time	$t_{d(on)}$		4.9		nS	$V_{DD}=10V, I_D=1A, R_G=6.8\Omega, V_{GS}=4.5V$
Turn-on rise time	t_r		7.5		nS	
Turn-off delay time	$t_{d(off)}$		19		nS	
Turn-off fall time	t_f		12		nS	
Total gate charge	Q_g		8.9		nC	
Gate-source charge	Q_{gs}		0.68		nC	$V_{DS}=10V, V_{GS}=4.5V, I_D=6.3A$
Gate-drain charge	Q_{gd}		4.4		nC	
Diode forward current(Body Diode)	I_S			1.3	A	
Pulsed Source Current(Body Diode)	I_{SM}			32	A	
Diode forward voltage (note 1)	V_{SD}			1.2	V	$I_S=6.3A, V_{GS}=0V, T_J=25^\circ C$
Reverse Recovery Time	t_{rr}		12	18	nS	$T_J=25^\circ C, V_R=15V, I_F=1.3A,$
Reverse Recovery Charge	Q_{rr}		5.1	7.7	nC	$di/dt=100A/\mu s$

Note:1. Pulse test ; Pulse width $\leq 400\mu s$, Duty cycle $\leq 2\%$.

MOSFET (N-CHANNEL)

Typical Characteristics

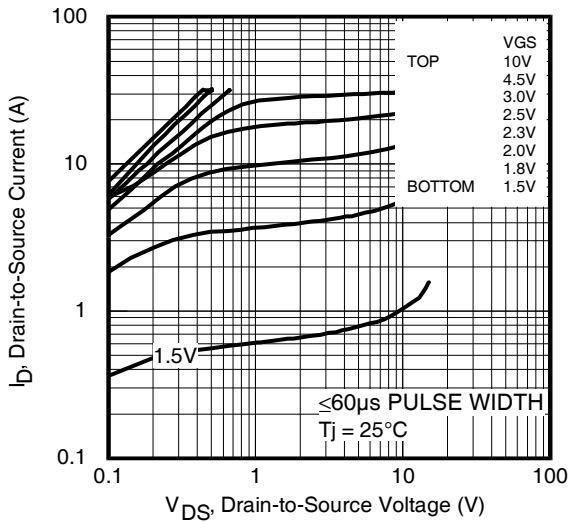

Fig 1. Typical Output Characteristics

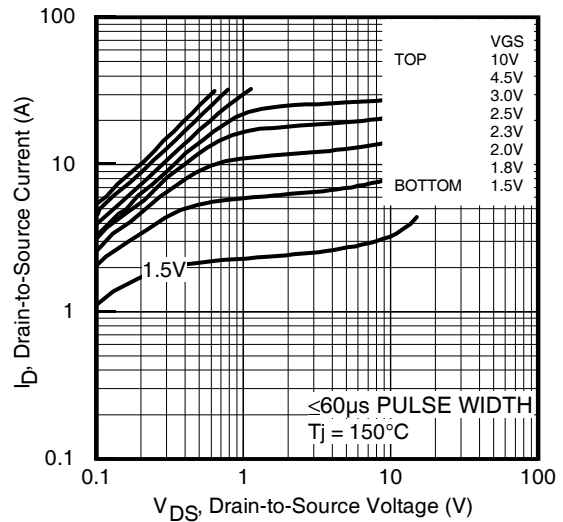

Fig 2. Typical Output Characteristics

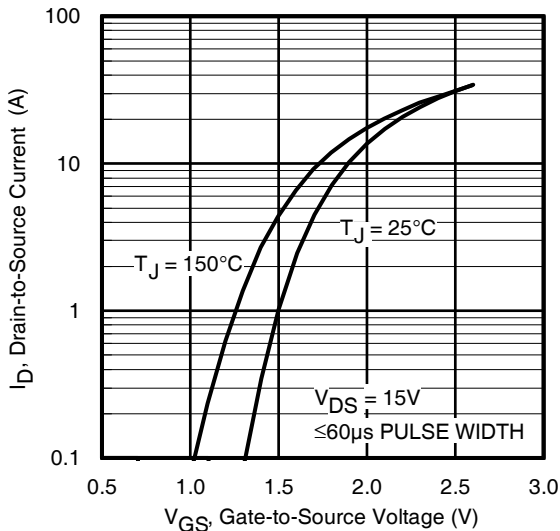

Fig 3. Typical Transfer Characteristics

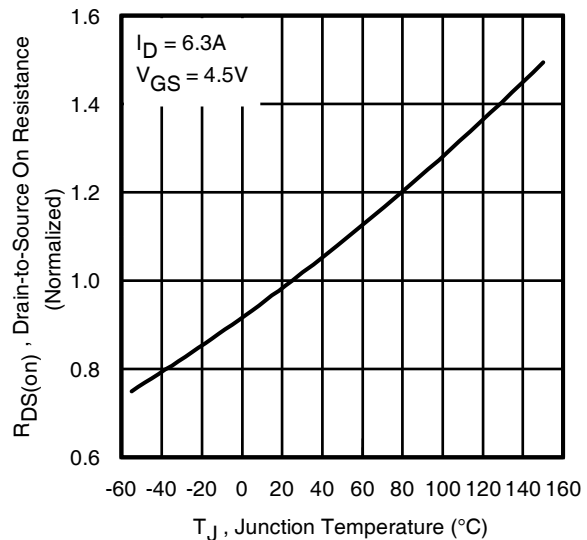

Fig 4. Normalized On-Resistance vs. Temperature

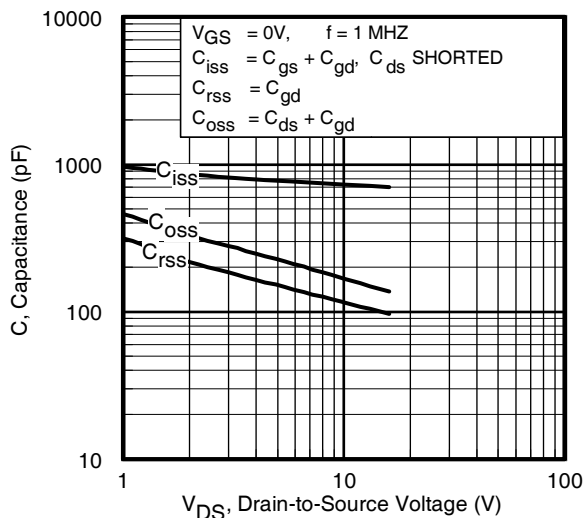

Fig 5. Typical Capacitance vs. Drain-to-Source Voltage

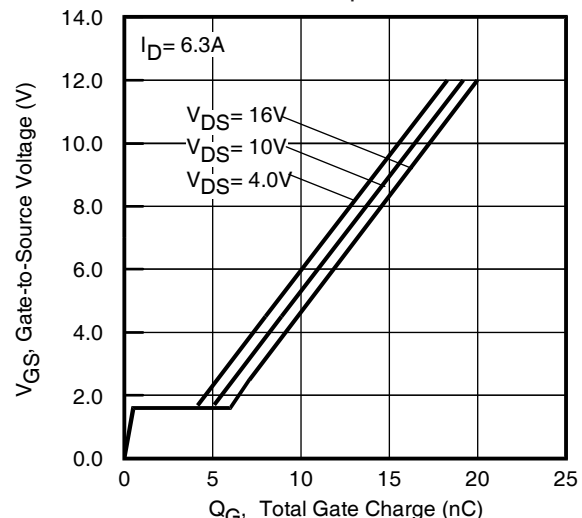

Fig 6. Typical Gate Charge vs. Gate-to-Source Voltage

MOSFET (N-CHANNEL)

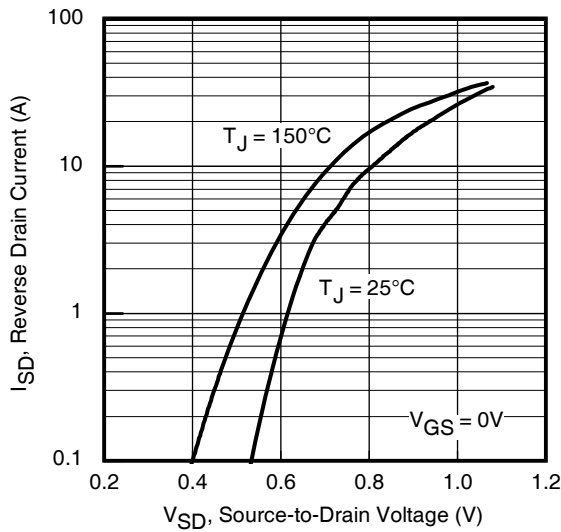

Fig 7. Typical Source-Drain Diode Forward Voltage

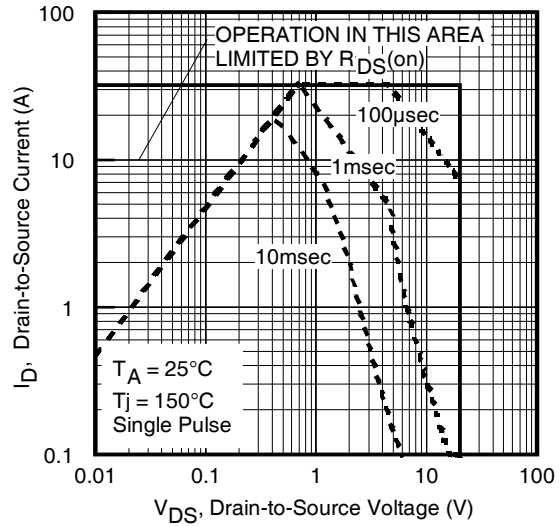

Fig 8. Maximum Safe Operating Area

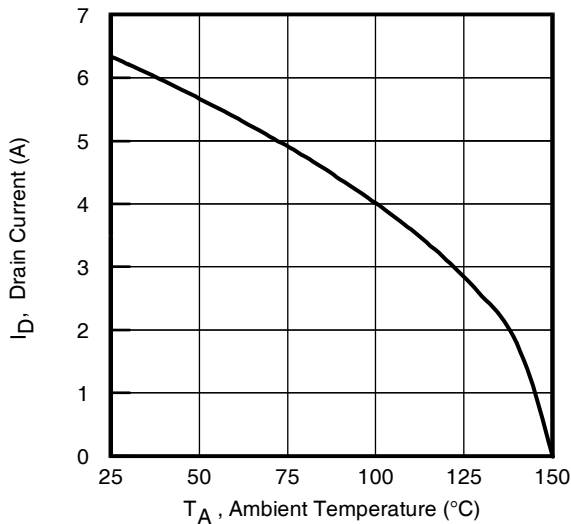

Fig 9. Maximum Drain Current vs. Ambient Temperature

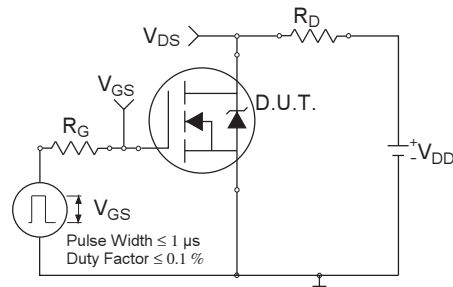

Fig 10a. Switching Time Test Circuit

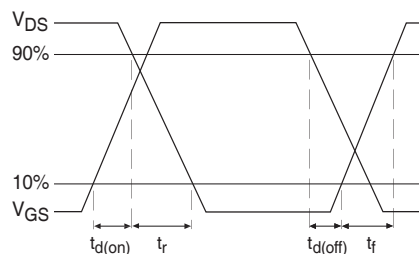

Fig 10b. Switching Time Waveforms

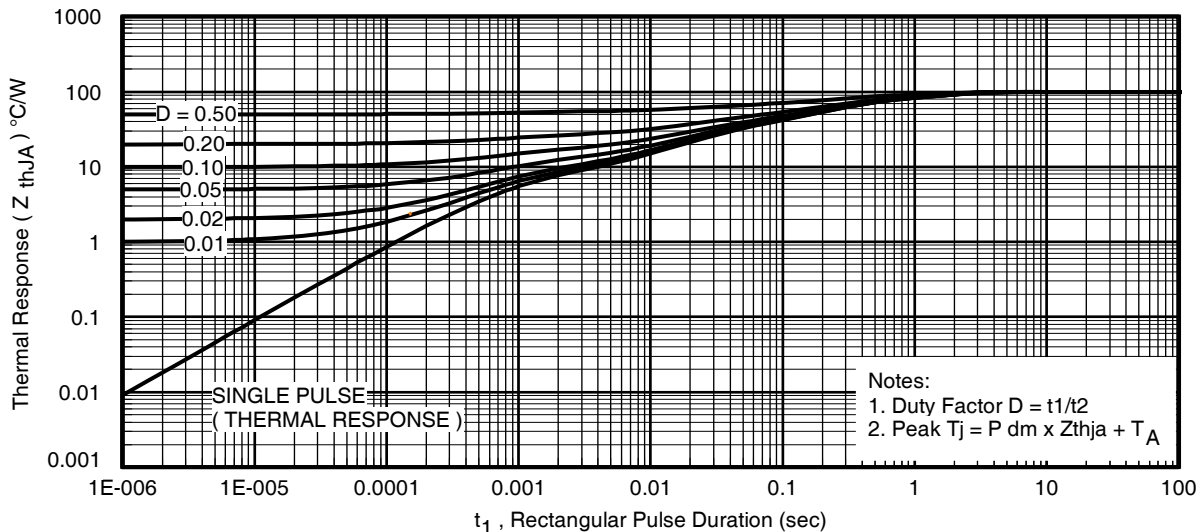

Fig 11. Typical Effective Transient Thermal Impedance, Junction-to-Ambient

MOSFET (N-CHANNEL)

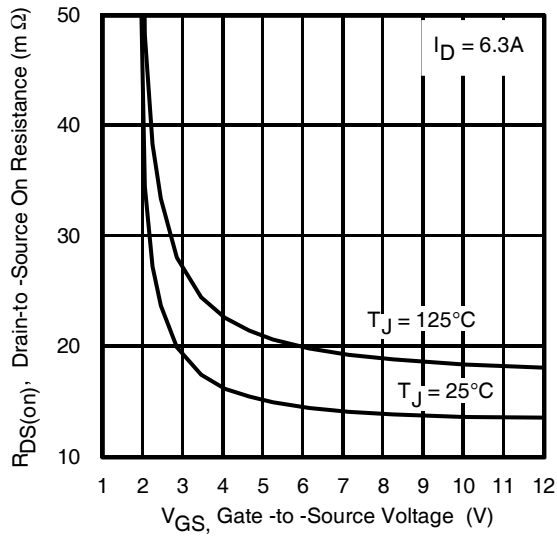

Fig 12. Typical On-Resistance vs. Gate Voltage

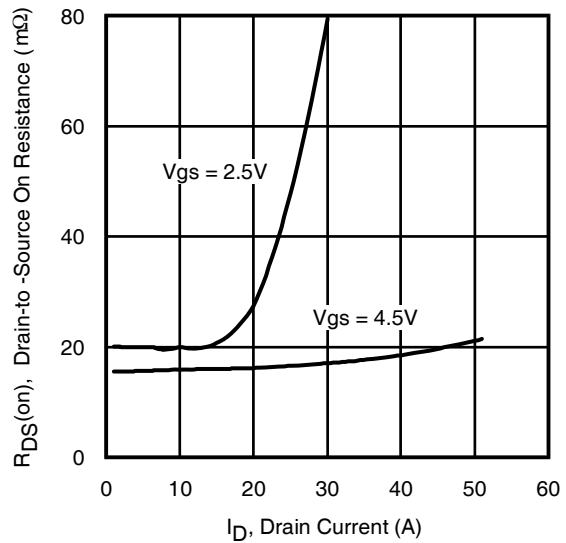

Fig 13. Typical On-Resistance vs. Drain Current

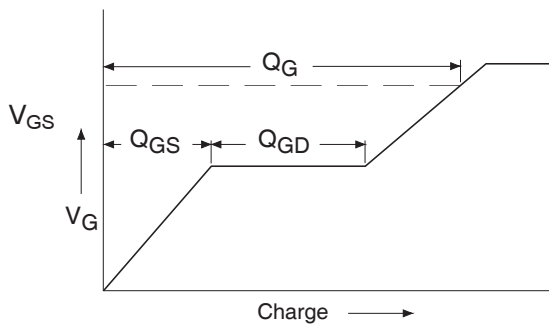

Fig 14a. Basic Gate Charge Waveform

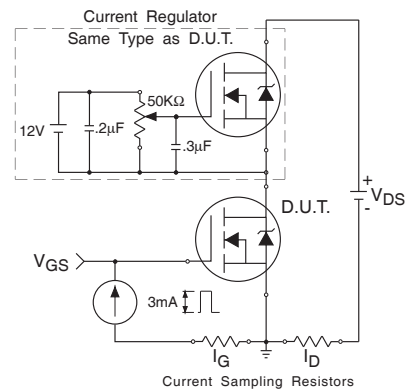

Fig 14b. Gate Charge Test Circuit

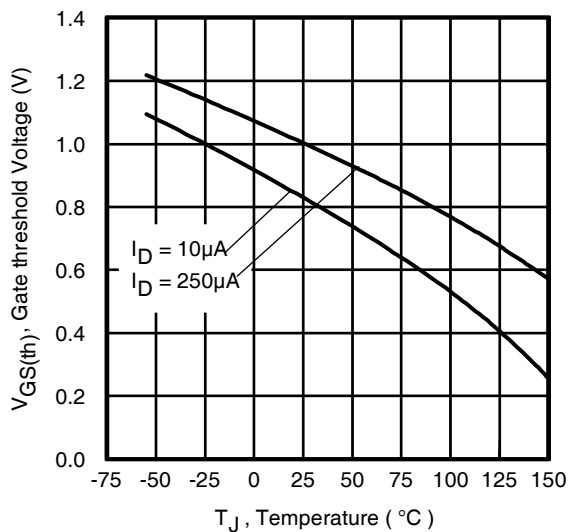

Fig 15. Typical Threshold Voltage vs. Junction Temperature

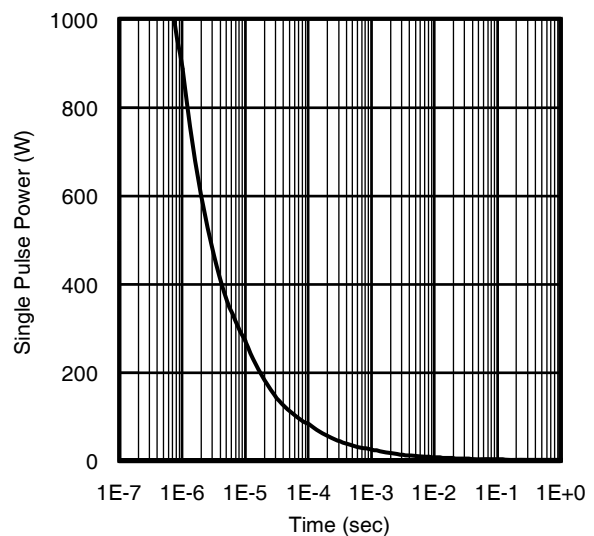
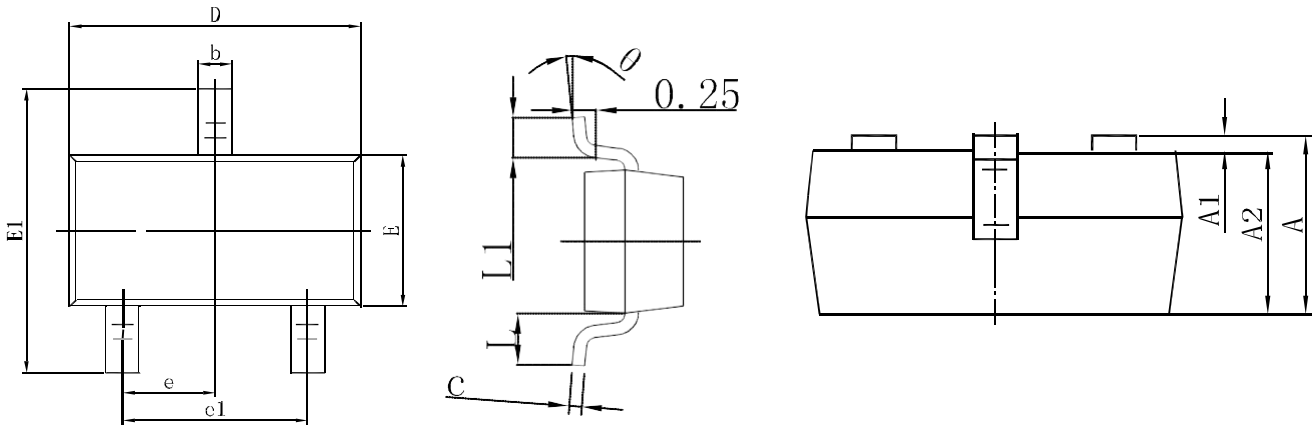

Fig 16. Typical Power vs. Time

MOSFET (N-CHANNEL)

SOT-23 Package Outline Dimensions



Symbol	Dimensions In Millimeters		Dimensions In Inches	
	Min.	Max.	Min.	Max.
A	0.900	1.150	0.035	0.045
A1	0.000	0.100	0.000	0.004
A2	0.900	1.050	0.035	0.041
b	0.300	0.500	0.012	0.020
c	0.080	0.150	0.003	0.006
D	2.800	3.000	0.110	0.118
E	1.200	1.400	0.047	0.055
E1	2.250	2.550	0.089	0.100
e	0.950 TYP		0.037 TYP	
e1	1.800	2.000	0.071	0.079
L	0.550 REF		0.022 REF	
L1	0.300	0.500	0.012	0.020
θ	0°	8°	0°	8°

SOT-23 Suggested Pad Layout

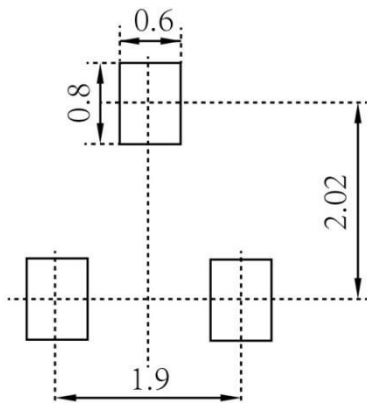

Note:

1. Controlling dimension: in millimeters
2. General tolerance: $\pm 0.05\text{mm}$
3. The pad layout is for reference purposes only

MOSFET (N-CHANNEL)

SOT-23 Tape and Reel

SOT-23 Embossed Carrier Tape

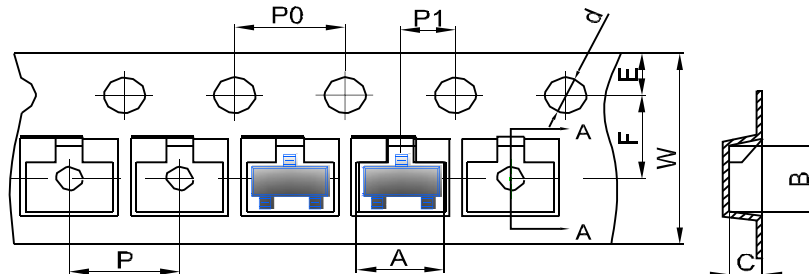

DIMENSIONS ARE IN MILLIMETER										
TYPE	A	B	C	d	E	F	P0	P	P1	W
SOT-23	3.15	2.77	1.22	Ø1.50	1.75	3.50	4.00	4.00	2.00	8.00
TOLERANCE	±0.1	±0.1	±0.1	±0.1	±0.1	±0.1	±0.1	±0.1	±0.1	±0.1

SOT-23 Tape Leader and Trailer

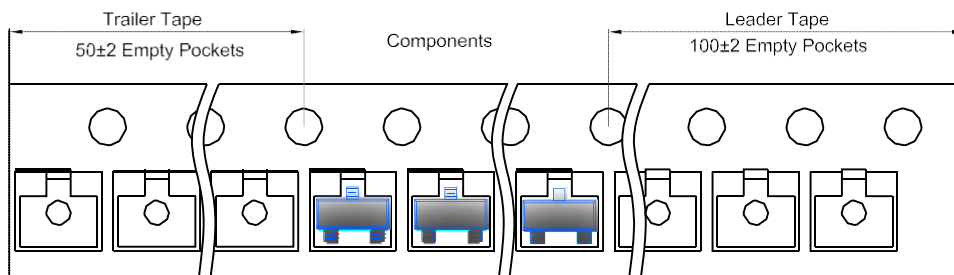

SOT-23 Reel

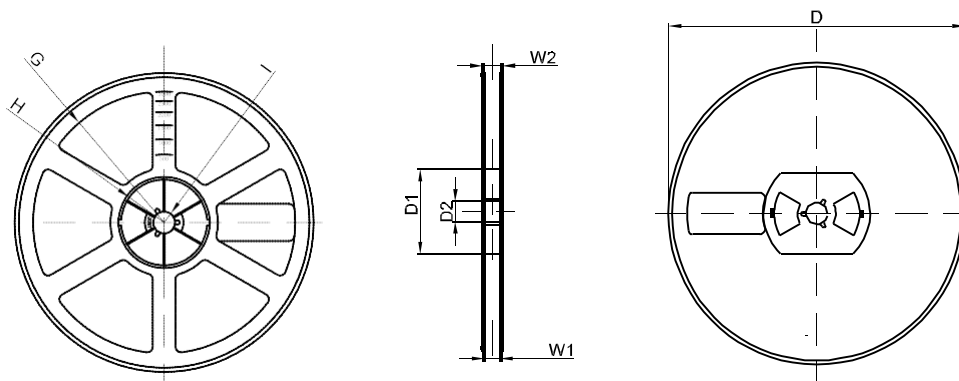

DIMENSIONS ARE IN MILLIMETER								
REEL OPTION	D	D1	D2	G	H	I	W1	W2
7" DIA	Ø178	54.40	13.00	R78	R25.60	R6.50	9.50	12.30
TOLERANCE	±2	±1	±1	±1	±1	±1	±1	±1